

UHER

SG 631 LOGIC

Operating Instructions

The SG 631 LOGIC represents the utmost in tape recorder technology of today. As an aid to you in familiarizing yourself with its new techniques, we are supplying highly detailed operating instructions and recommend that you read them carefully. If, however, you are already very familiar with the operation of modern tape machines, you will simply need to read certain sections. Each chapter forms a closed unit and refers, only when absolutely necessary, to other parts of the manual, that, in turn, may be located easily by using the table of contents.

For full utilization of the new technologies offered by the SG 631, the points below should be followed carefully:





1. Use UHER NAB Adapter Z 800 to avoid even the slightest play between reel and hub shaft (see sec. 1.6).
2. Use UHER "professional" metal reels (Z 827) as they guarantee smooth movement for all tape transport functions and decrease tape wear (see sec. 6.10).
3. UHER "professional" tape Z 830 is recommended for optimum operational results and best electro-acoustical values (see sec. 6.10).
4. Always use reels of the same size and of the same material together (see sec. 6.10).
5. Make certain that the CUEING switch is set to "0" for all modes of operation except CUEING to avoid tape spilling (see sec. 3.18).
6. Make certain that the reel size switch is set to the appropriate position (see sec. 3.24).
7. Read Chapter 7 "Care and Maintenance" with especial care.
8. When the SG 631 is operating in the fast-wind mode, for safety reasons neither move it from horizontal to vertical operating position nor touch the reels under any condition.
9. At the end of the Operating Instructions you will find a list of UHER accessory equipment available from your UHER dealer to supplement your recording system.





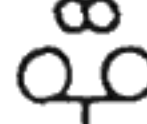

Contents

1. Setting up the SG 631 LOGIC for Recorder Playback Operation

- 1.1 Air Circulation
- 1.2 Operating Position
- 1.3 Extending Connecting Leads
- 1.4 A.C. Mains Connection, Operating Voltage, Frequency, Mains Fuse
- 1.5 Mounting Feet for Upright Operation
- 1.6 Mounting UHER NAB Adapter Z 800 for 26.5 cm (10½") Reels and Loading Tape
- 1.7 Record Operation for Users in a Hurry
- 1.8 Playback Operation for Users in a Hurry

2. Socketry

- 2.1 MICROPHONE 
- 2.2 HEADPHONES (5-Pin) 
- 2.3 HEADPHONES (Phone Jack) 
- 2.4 DUBBING Output 
- 2.5 RADIO Input/Output 
- 2.6 PHONO Input 

- 2.7 DIA (Slide) 
- 2.8 MONITOR 5-Pin Output
- 2.9 ACCESSORY 
- 2.10 MONITOR Jack Output 
- 2.11 INPUT 2 (Jack) 
- 2.12 INPUT 1 (Jack) 
- 2.13 OUTPUT (Jack) 

3. Operating Controls and Their Functions

- 3.1 Microphone Record Level Controls L ① and R ②
- 3.2 Radio/Phono Record Level Controls L ③ and R ④
- 3.3 Master Control ⑤ for Fading in, Out or Over from Radio/Phono Inputs to Microphone Input during Record
- 3.4 Record Level Meter ⑥
- 3.5 LIMITER Switch ⑦
- 3.6 Mode Selector ⑧
- 3.7 MONITOR Switch ⑨
- 3.8 Tape Speed Selector ⑩
- 3.9 REC(ORD) Key ⑪
- 3.10 Rewind Key ⑫ 

- 3.11 START Key ⑬
- 3.12 PAUSE Key ⑭
- 3.13 STOP Key ⑮
- 3.14 Fast Forward Key ⑯
- 3.15 Counter with Zero Reset Button/Off-Switch for Automatic Shut-Off ⑰
- 3.16 POWER On/Off Switch ⑱
- 3.17 Headphones Volume Control ⑲
- 3.18 CUEING Switch ⑳
- 3.19 "DIA" (Slide Control Pulse) Button ㉑
- 3.20 OUTPUT LEVEL Control ㉒
- 3.21 TAPE SELECT Switch ㉓
- 3.22 Stroboscope Discs 50 Hz ㉔ and 60 Hz ㉕
- 3.23 Find Speed Adjuster (7 1/2 ips)/Pitch Control ㉖
- 3.24 Reel-Size Switch ㉗

4. Record Operation for True Audio Enthusiasts

- 4.1 Input and Output Connections
- 4.2 Power Supply
- 4.3 Preparing to Record
- 4.4 Making Record Level Test and Starting to Record

5. Playback Operation for True Audio Enthusiasts

- 5.1 Playback through Hi-Fi Sound System Amplifier
- 5.2 Playback through Stereo Headphones

6. Further Hints and Tips

- 6.1 Transcribing onto Another Tape Recorder (Dubbing)
- 6.2 Monitoring via the MONITOR Output
- 6.3 Sound for Slide Shows
- 6.4 Recording with UHER Telephone Adapter A 261
- 6.5 Erasing Only
- 6.6 Changing Tape Head Assembly Z 401 or Z 411 (See Fig. 6)
- 6.7 Azimuth Adjustment of Playback Head
- 6.8 Putting On the Transparent Dust Cover Z 630
- 6.9 Operation of the SG 631 LOGIC with UHER Timer A 403
- 6.10 Tapes and Reels

7. Care and Maintenance

- 7.1 Cleaning Tape-Touching Parts (See Fig. 6)
- 7.2 Cleaning the Housing

1. Setting up the SG 631 LOGIC for Record Playback Operation

1.1 Air Circulation

The greatest amount of heat develops around the power transformer which is located at the center of the ventilating slits. The ventilating slits must be left free regardless of the machine's operating position. When installing the machine in a cabinet, a closed section of wall shelves, etc., be certain to allow for sufficient air circulation to assure proper heat exchange.

1.2 Operating Position

The SG 631 LOGIC may be operated in either upright *or* horizontal position, or if desired, in any tilted position. In all operating positions, however, care must be taken that the spools are securely held onto the hub spindles as described in sec. 1.6 below.

1.3 Extending Connecting Leads

When matching UHER plug-in extension leads are not used, connecting leads should be extended only by an experienced service technician (see also secs. 2.3, 2.4 and 2.5).

1.4 A.C. Mains Connection, Operating Voltage, Frequency, Mains Fuse

The mains lead is attached to the machine and is located in the covered recess in the floor (or rear) of the housing (see Fig. 1). Before plugging the lead into a mains power outlet, ascertain the voltage of the power supply.

The SG 631 LOGIC is factory-set to an operating voltage of 220 V, but may be adjusted to operate on 115 V A.C. If necessary, set the voltage selector to the proper voltage.

Before adjusting the voltage, make certain that no leads are connected to a mains power outlet and that the mains fuse, located in the fuse holder "A" (Fig. 1) corresponds with the voltage to be selected. With the aid of a coin, unscrew the fuse holder. Use a 0.8 A fuse for 220 V A.C., and a 1.6 A fuse for 115 V. Once the proper fuse has been inserted, the operating voltage may be chosen by turning the voltage selector "B" (Fig. 1) with a coin. The voltage value selected will appear in the recess "C" (Fig. 1) of the voltage selector.

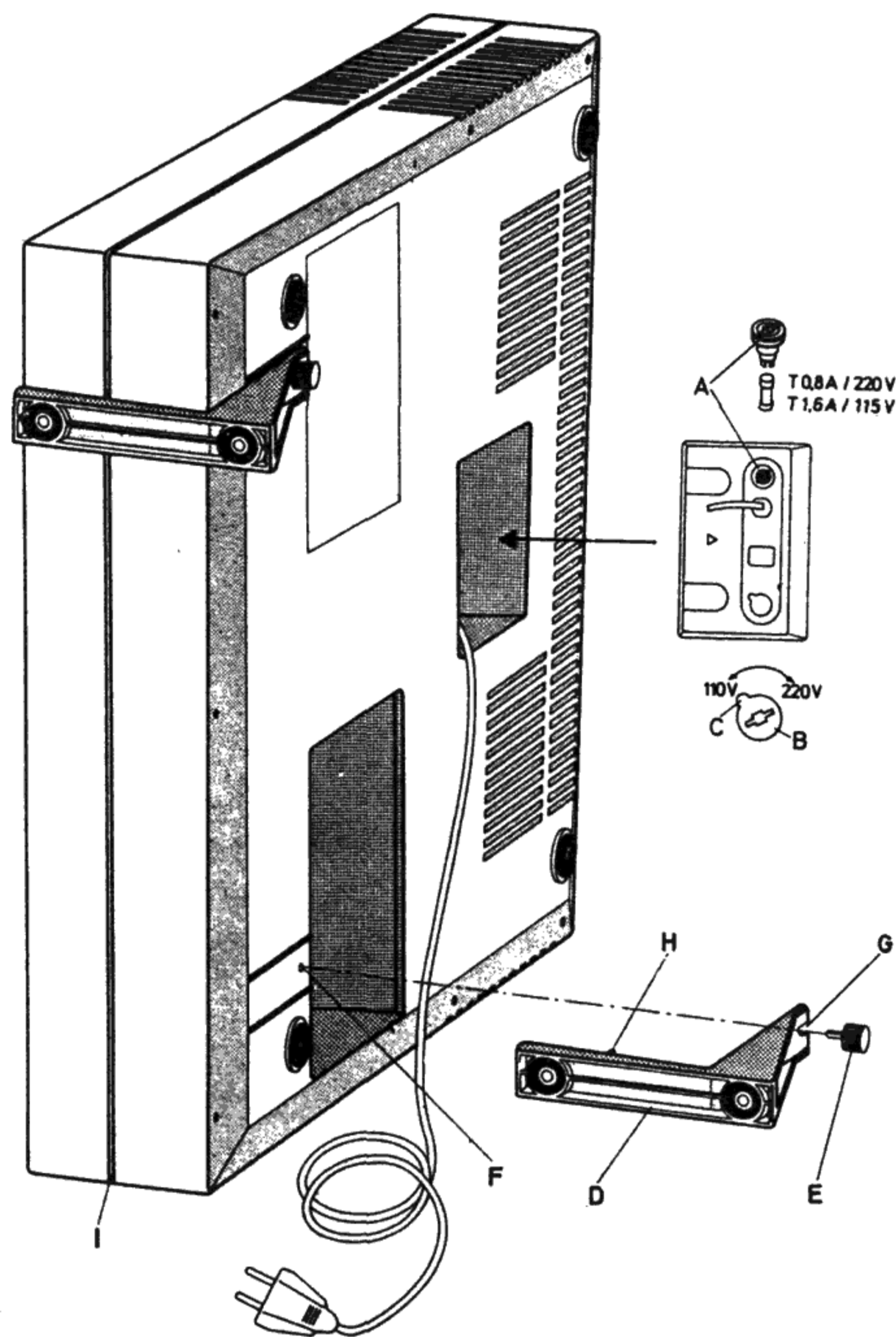

Fig. 1

It is not necessary to adjust the SG 631 LOGIC to a mains frequency of 50 Hz or 60 Hz as the machine uses D.C. motors and the power supply unit is designed for operation with either frequency.

Note:

Extreme overloading of the power supply unit or internal short-circuiting activates an automatic guard circuit that switches off the power supply unit. Disengaging then re-engaging the POWER push-button returns the guard circuit to its "alert" function. Fuses for the D.C. voltages in the machine may also burn out when the guard circuit is activated. Such fuses should be replaced only by a service technician as the cause of the blow-out must be detected and, if necessary, removed.

1.5 Mounting Feet for Upright Operation

For upright operation, two feet "D" are provided with each machine (see Fig. 1). To mount them, first lay the machine on one side. Turn fixing screws "E" a few times into the threadings "F". Next push notches "G" in the feet "D" under the head of the fixing screws "E" until the bridge catches in groove "I". Then tighten fixing screws "E".

1.6 Mounting UHER NAB Adapter Z 800 for 26.5 cm (10½") Reels and Loading Tape

The NAB adapter must be carefully placed on the right and/or left hub spindle. First, pull up the three-pronged mandrel (A) of the spindle (see Fig. 2) and turn it until the prongs of the movable section rest on those of the stationary section. The inner ring (B) of the NAB adapter must also be turned to the left until the clamping jaws (C) for the three-pronged mandrel (A) are opened so wide that the adapter may be easily set upon the spindle. Once the adapter has been set in place (see Fig. 3), the three-pronged mandrel (A) should be turned to the right or to the left until it jumps down into the grooves of the stationary section. The adapter is then prevented from falling off. The inner ring (B) of the clamping jaws should then be turned to the right, closing it until the adapter is tightly secured to the three-pronged mandrel. Tightening the clamping jaws is of particular importance as it will prevent any play between the mandrel and the NAB adapter.

NAB adapters without clamping jaws cannot do away with the play between mandrel and adapter. If the play is too great, however, poor speed stability and poor tape wind may result. (Mounting such NAB adapters and securing them against falling off is best accomplished as described for UHER NAB adapters.)

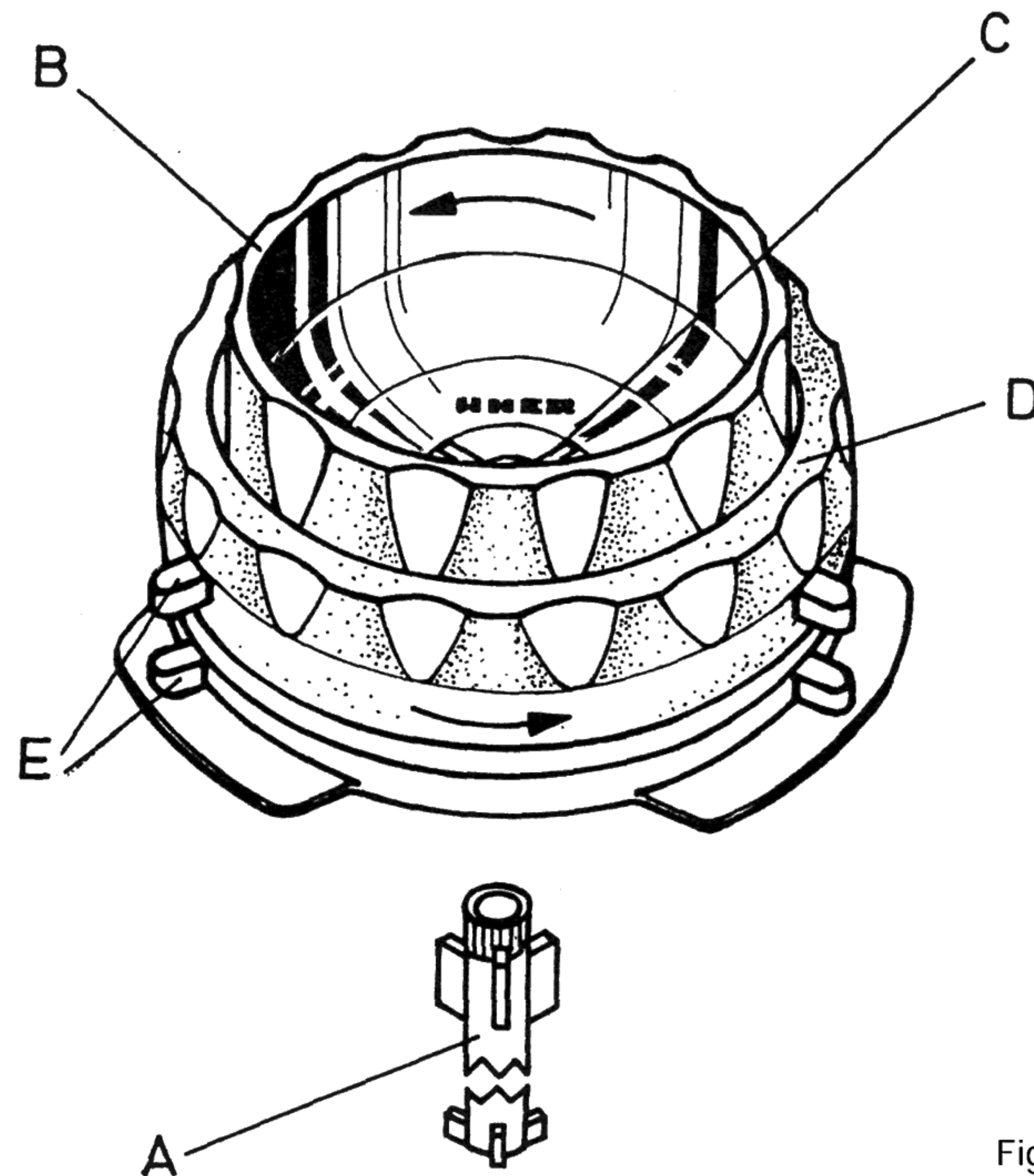

Fig. 2

Before placing a 26.5 cm (10½") reel on the NAB adapter, turn the outer ring (D) of the adapter anti-clockwise until the three keys of the movable part of the ring are above those of the lower stationary part (see Fig. 2). The full reel of tape should be placed on the left NAB

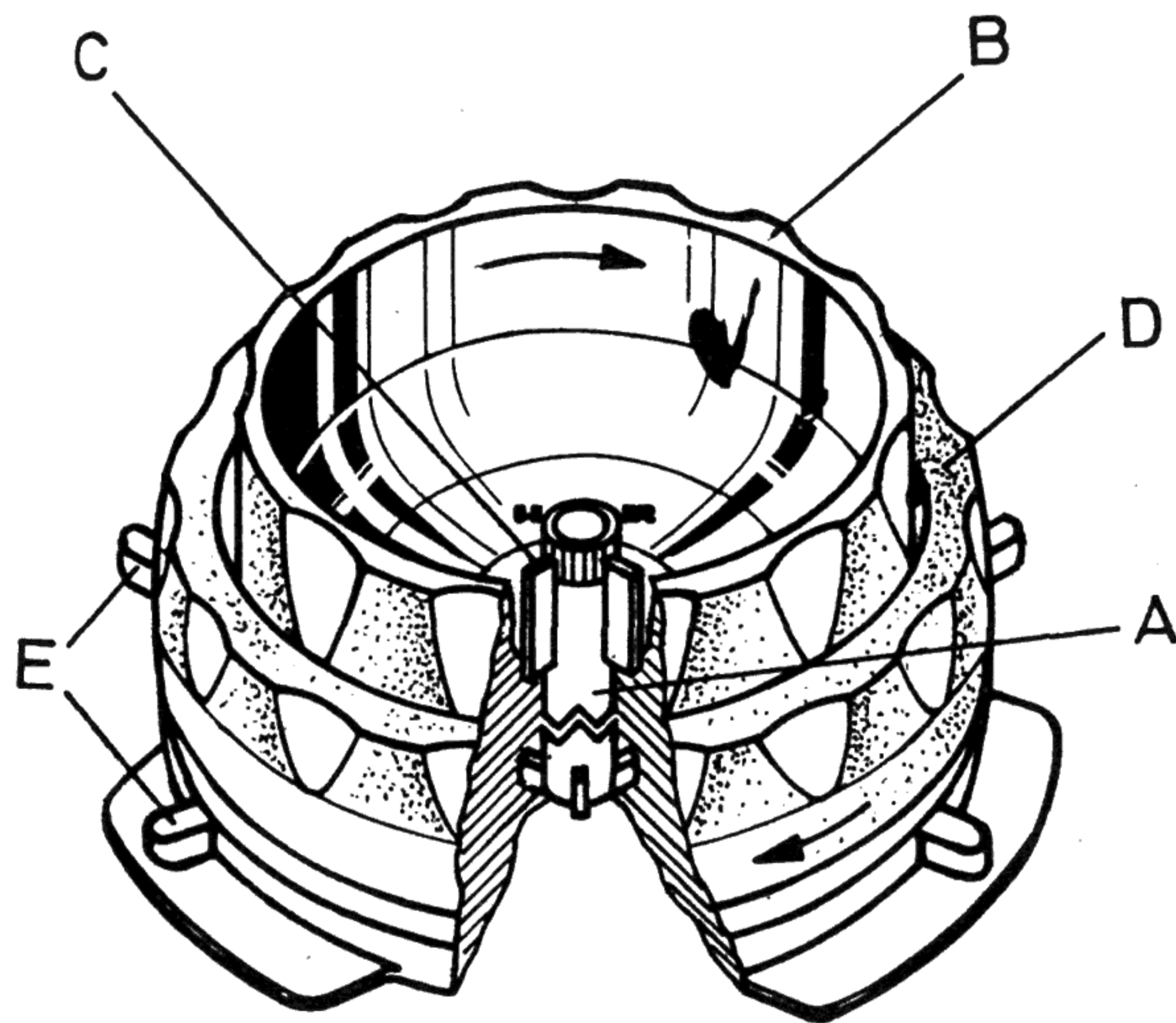

Fig. 3

adapter, the empty reel on the right adapter. Once the reel is in place, turn the outer ring of the adapter clockwise until a clear stop is felt (see Fig. 3).

To thread the tape, run a tape lead of about 50 cm (20") from the left-hand (supply) reel - without slack - past the tape tension sensor into the threading slot between the front tape-head cover and the tape-head assembly, out past the right tension sensor onto the right (take-up) reel and turn the take-up reel until the supply reel is turned along with it. On pressing the power switch and actuating the START or FAST FORWARD key, the tape lead will wind onto the take-up reel until the transparent or metal-coated switching foil appears. The foil activates an automatic shut-off switch for all deck functions. The foil-activated switch may be disengaged by pressing the counter reset button; hence, with the reset button down, lightly touching the START or FAST FORWARD key will begin tape transport again. The zero reset button © must be held down until the switching foil has cleared the tape head assembly.

Note: Tapes which have been played or recorded on other tape machines must be inspected to make certain that they are tightly wound onto the reel. If necessary, unwind and rewind the tapes on your SG 631 before using them to record or replay.

To facilitate loading tape when small sized reels (under 18 cm) are used, first press the PAUSE ⑭ and CUEING ⑳ keys; then deactivate them after loading tape on it.

1.7 Record Operation for Users in a Hurry

As the quality of the recording is essentially dependent upon the correct setting of the record level, this step should be given particular attention:

1. Make certain that the input source to be used in recording is connected and switched on.
2. Press POWER switch ⑱ (Check connection to mains power outlet). Function indicator above STOP key must light up.
3. Load tape and wind past switching foil onto take-up spool (see secs. 1.6 and 3.15).
4. Set a) tape type switch ⑳ for tape used (see sec. 3.21),
b) reel size switch ㉑ (see sec. 3.24),
c) mode selector switch ㉒ to desired record mode (see sec. 3.6) and
d) tape speed selector ㉓ (see sec. 3.8).
5. Touching them lightly, one after another, actuate the RECORD®, PAUSE ㉔ and START ㉕ keys. The function indicators above the keys will light up.
6. Press the zero reset button of the counter to mark the beginning of the recording.
7. Using the master control ㉖, fade in the desired input sources (see sec. 3.3).
8. Using level controls ㉗ to ㉘, set maximal record level for loudest passages to be recorded (see secs. 3.1 and 3.2).
9. Press LIMITER switch ㉙ and check setting for correct (maximal) record level (see sec. 3.5).
10. Tip PAUSE key ㉚ once more. Tape transport and recording will begin. Tipping the PAUSE key still again will interrupt tape motion and recording.
11. Connect stereo headphones (see sec. 2.2) and adjust their volume, using headphone volume control ㉛. Check recording acoustically (as described in sec. 3.7) by pressing the MONITOR switch ㉜.
12. Lightly tipping the STOP key ㉝ ends record operation.
13. To switch the recorder off, press the POWER switch ⑱.

1.8 Playback Operation for Users in a Hurry

Playback may be directly through the machine's headphones power stage (which permits connection of two stereo headphones) or through the loudspeakers of your hi-fi sound system.

Procedure:

1. Make certain that the amplifier connected for playback through the sound system speakers is switched on - or that the headphones are connected (see secs. 2.2, 2.4 and 2.7).
2. Switch on recorder by pressing POWER button ⑱. The function indicator above the STOP key ⑮ must light up.
3. Load tape reels and lock. Thread tape and wind onto take-up reel past switching foil (see secs. 1.6 and 3.15).
4. Set a) tape type switch ㉓ for tape used (see sec. 3.21),
b) reel size switch @ (see sec. 3.24),
c) mode selector switch ⑧ to desired playback mode (see sec. 3.6) and
d) tape speed selector ⑩ (see sec. 3.8).
5. Lightly tip START key ⑬. The function indicator above the key should light up, and tape transport should begin as soon as the OMEGA loop is formed.
6. Set volume as desired for headphones via headphones volume control ⑲, for loudspeakers via volume controls on the power amplifier of the hi-fi sound system.
7. When playback is through the sound system amplifier, correct tone and balance settings, if needed.
8. If necessary, set MONITOR switch ⑨ in off-TAPE position.

2. Socketry

Data on pin wiring as well as input/output sensitivities and impedances are supplied as an aid to the technician (e.g., in constructing special connecting leads) to assure optimum matching with input sources and playback equipment.

2.1 MICROPHONE

All commercially available low-impedance dynamic stereo microphones (200 to 500 ohms) equipped with DIN plugs may be directly connected to this socket. For stereo recording with two mono microphones, UHER Adapter Lead K 626 should be used. Care must be taken that the plug of the adapter is inserted into the socket fully up to the stop.



UHER K 110 is the extension lead for use with low-impedance mono microphones, K 134 for use with stereo microphones (see list of accessories at the end of the Operating Instructions).

UHER dynamic stereo microphone M 641 and UHER electret condenser microphone M 646 may be directly connected. Their earlier models M 640 and M 645, on the other hand, require UHER Adapter K 822 for connection.



Input signals at pins 3/2 and 5/2 (2 = ground) should be between 0.1 mV and 80 mV. All commercially available condenser microphones with (DIN 45326) 8-pin plug may be connected to this socket. The plus pole of the microphone power supply (+ 20 V, source impedance 1.2 kohms) is located at pin 8.

2.2 HEADPHONES (5-Pin)

This socket is for connecting a stereo headphone set equipped with a 5-pin plug (like UHER W 775) for monitoring record or playback. All high or low impedance headphones currently available on the market may be connected (output impedance 8 to 2,000 ohms). UHER Adapter K 633 must be used when connecting headphones with two LS-7 plugs (like UHER W 774).

When listening to playback, the MONITOR switch  should be in off-tape (TAPE) position and the volume regulated with the headphones volume control  .

2.3 HEADPHONES (Phone Jack)

This facility is for connecting a stereo headphone set equipped with a jack plug. All high or low impedance headphones currently available on the market may be connected (output impedance 8 to 2,000 ohms). When listening to playback, the MONITOR switch  should be in off-tape (TAPE) position and the volume regulated with the headphones volume control  .

2.4 DUBBING Output

This socket is for convenient tape copying onto a second open-reel or cassette tape recorder. Using UHER Stereo Connecting Lead K 541, connect this DUBBING socket to the RADIO socket of the recording tape machine. Output signals delivered to pins 3/2 and /2 (2 = ground) are approximately 750 mV (output impedance less than 15 kohms).

2.5 RADIO Input/Output

This socket is a combined input and output for connection to a stereo tuner or receiver with DIN standard sockets. For record or playback use UHER inter-unit Stereo Lead K 541 to connect the SG 631 LOGIC to the TAPE socket of the tuner or receiver.

With mono equipment, UHER Adapter K 837 must be inserted into the TAPE socket of the mono set before using the K 541 lead to make connection to the SG 631 LOGIC.

To avoid loss of response in the high frequency range during record and playback, the connecting lead (K 541) should be extended only by a service technician, and then only if the output impedance of the input source or the input impedance of the playback equipment permits. Input signals at pins 1/2 and 4/2 (2 = ground) of this socket may be between 1 mV and 200 mV (input impedance 27 kohms). For input voltages over 250 mV, it is advisable to use the PHONO input socket.

Output signals delivered to pins 3/2 and 5/2 (2 = ground) are approximately 750 mV (output impedance maximum 15 kohms).

2.6 PHONO Input

This socket is for connecting stereo record players with DIN plugs and crystal pickup cartridges. Record players with magnetic pickup must be equipped with their own equalizing amplifier. High-impedance equipment (e.g. stereo tape or cassette recorders, stereo receivers or UHER mixer Mix 500 A 124) may also be connected to this socket, using UHER Stereo Lead K 541.

Input signals at pins 3/2 and 5/2 (2 = ground) may be between 80 mV and 10 V (input impedance 680 kohms).

2.7 DIA (Slide)

This socket is for connecting automatic slide projectors via UHER Projector Lead K 911. Pins 2 and 3 are for slide changing by signalling the "Dia-Pilot" of the SG 631 LOGIC to scan the 1 kHz pulses recorded on the tape. The "Dia" tape head run-out to pins 4 and 6 (6 = ground) permits control of multi-vision projectors that operate with pulses up to 7 kHz. In addition, this tape head is also for record and playback of the pulses responsible for synchronizing tape recorder and projector in 8 mm and 16 mm film dubbing.

2.8 MONITOR 5-Pin Output

This socket is for connecting the SG 631 LOGIC to an amplifier with a monitor input, using UHER Stereo Connecting Lead K 541. Use the amplifier's switch to select "from source" or "off-tape" monitoring. Give careful attention to the instructions in the operating manual of the amplifier.

Output signals delivered to pins 3/2 and 5/2 (2 = ground) are approximately 750 mV (output impedance 15 kohms).

2.9 ACCESSORY A

This socket is for connecting a starting switch (see sec. 6.9) when operating with a timer. When using UHER Timer A 403, the SG 631 LOGIC is automatically switched to RECORD and START functions as soon as the timer switches on the power supply of the recorder. The PAUSE function may be switched by remote control if pins 3 and 4 of this socket are connected together.

2.10 MONITOR Jack Output

This stereo output is for connecting the SG 631 to an amplifier with monitor switching. Use the amplifier's switch to select "source" or "off-tape" monitoring, paying careful attention to the instructions in the operating manual of the amplifier.

Signals delivered to this output are approximately 750 mV per channel (output impedance 15 kohms).

2.11 INPUT 2 (Jack)

This stereo input is for connecting the SG 631 to high-level input sources like stereo record players with crystal pickup systems, stereo tape (open-reel or cassette) recorders, stereo tuners or receivers. Stereo record players with magnetic pickups must have their own equalizing pre-amplifier to be connected to this input.

Input signals may range between 80 mV and 10 V (input impedance 680 kohms per channel).

2.12 INPUT 1 (Jack)

This stereo input is for making connection to low-level input sources having output voltages between 1 mV and 200 mV.

Input signals at these jacks may range between 1 mV and 200 mV (impedance 27 kohms per channel).

2.13 OUTPUT (Jack)

These stereo jacks are for connecting the SG 631 to stereo tuners, receivers and amplifiers equipped with jack connecting facilities. Output signal strength is approximately 750 mV per channel (output impedance 15 kohms).

3. Operating Controls and Their Functions

3.1 Microphone Record Level Controls L ① and R ②

Knobs ① and ② are for setting the record level of the left and right channels (respectively) of a stereo microphone connected to the MICROPHONE input. When setting the record level, the master control ⑤ should be pushed to the left all the way to the stop, the peak level limiter remaining out of circuit for the moment. The correct record level has been achieved when the corresponding level indicator registers 0 dB at the loudest passages to be recorded. The LIMITER switch (7) may then also be pressed. The peak level limiter will thus be in circuit and will prevent overloading the tape by reducing the record signal to a manageable level for the duration of the signal peaks that may be incurred. The function indicator beside the respective level meter will always light up when the peak level limiter is in operation. Lighting up briefly and in not too rapid succession indicates that the limiter is operating properly. Lighting up often or constantly indicates an incorrect record level setting that may easily occur during microphone recordings when the distance from the microphone is decreased. The degree of the overload is shown on the record level meter (see also sec. 3.4). The record level setting may be acoustically checked by making a test recording and monitoring through headphones with the MONITOR button (9) switched from TAPE to SOURCE position (see also sec. 3.7).

3.2 Radio/Phono Record Level Controls L ③ and R ④

Knobs ③ and ④ are for setting the record level of the left and right

channels (respectively) of stereo input sources connected to the RADIO or PHONO input sockets. When setting the record level, the master control ⑤ should be pushed to the right all the way to the stop. The remaining procedure is as described in sec. 3.1.

3.3 Master Control (5) for Fading in, Out or Over from Radio/Phono Inputs to Microphone Input during Record

This slide control has a middle click-position from which - once the record level has been set - radio or phono inputs may be blended over to record from the microphone (see secs. 3.1 and 3.2). Fading in, out or over of all input sources connected and switched on may be continuous and completely click-free. With the master control in middle position all input sources are switched out of circuit.

3.4 Record Level Meter

The record level meter has two separate indicator systems which register peak values for the signal to be recorded. The upper indicator system registers the record level of the left channel, the lower system that of the right channel.

The record setting decisively influences the quality of the recording. Setting the level too low (under-recording) impairs the signal-to-noise ratio that may be achieved because signal strength will not be able to cover the tape hiss sufficiently.

Setting the record level too high (overloading) increases harmonic

3. Operating Controls and Their Functions

3.1 Microphone Record Level Controls L ① and R ②

Knobs ① and ② are for setting the record level of the left and right channels (respectively) of a stereo microphone connected to the MICROPHONE input. When setting the record level, the master control ⑤ should be pushed to the left all the way to the stop, the peak level limiter remaining out of circuit for the moment. The correct record level has been achieved when the corresponding level indicator registers 0 dB at the loudest passages to be recorded. The LIMITER switch (7) may then also be pressed. The peak level limiter will thus be in circuit and will prevent overloading the tape by reducing the record signal to a manageable level for the duration of the signal peaks that may be incurred. The function indicator beside the respective level meter will always light up when the peak level limiter is in operation. Lighting up briefly and in not too rapid succession indicates that the limiter is operating properly. Lighting up often or constantly indicates an incorrect record level setting that may easily occur during microphone recordings when the distance from the microphone is decreased. The degree of the overload is shown on the record level meter (see also sec. 3.4). The record level setting may be acoustically checked by making a test recording and monitoring through headphones with the MONITOR button (9) switched from TAPE to SOURCE position (see also sec. 3.7).

3.2 Radio/Phono Record Level Controls L ③ and R ④

Knobs ③ and ④ are for setting the record level of the left and right

channels (respectively) of stereo input sources connected to the RADIO or PHONO input sockets. When setting the record level, the master control ⑤ should be pushed to the right all the way to the stop. The remaining procedure is as described in sec. 3.1.

3.3 Master Control (5) for Fading in, Out or Over from Radio/Phono Inputs to Microphone Input during Record

This slide control has a middle click-position from which - once the record level has been set - radio or phono inputs may be blended over to record from the microphone (see secs. 3.1 and 3.2). Fading in, out or over of all input sources connected and switched on may be continuous and completely click-free. With the master control in middle position all input sources are switched out of circuit.

3.4 Record Level Meter ⑥

The record level meter has two separate indicator systems which register peak values for the signal to be recorded. The upper indicator system registers the record level of the left channel, the lower system that of the right channel.

The record setting decisively influences the quality of the recording. Setting the level too low (under-recording) impairs the signal-to-noise ratio that may be achieved because signal strength will not be able to cover the tape hiss sufficiently.

Setting the record level too high (overloading) increases harmonic

distortion and leads to playback that sounds too shrill and distorted. The maximal harmonic distortion permissible is 3% and is reached when the level meter reads 0 dB with the machine set for full record level (using DIN reference tape). With the maximal record level above 0 dB, distortion rises far above 3% and rapidly sinks to 1% or less with the maximal record level below 0 dB.

Each level registering system is equipped with an illuminated indicator that functions when the peak limiter is switched in circuit (see also sec. 3.5). Although the function indicators of the peak limiter are signalled parallel to the level indicators, it is possible that with the limiter in-circuit its function indicators may light up at brief signal peaks even if the level meter does not yet register 0 dB - because the level indicating systems are slightly sluggish due to the mass that must be moved. When setting the record level without using the limiter, however, this effect has no influence upon the quality of the recording as the response time of the level meter is sufficiently brief. (Even the light exposure meters used in commercial sound studios are "much" slower than the illuminated function indicators which operate inertialessly.)

Aside from optical control by means of the record level meter, an acoustical check may be made during record with the aid of the monitor switch (see sec. 3.7). Even during playback the two separate indicator systems of the level meter register the peak values of the signals recorded on the tape.

3.5 LIMITER Switch ⑦

The LIMITER button catches in down-position and switches on the peak-limiting circuit that, when the record level is too high (pointer in red field of meter), reduces the record signal to a manageable level for the

duration of the overloading. The degree of overloading is shown on the level meter while the two function indicators, located next to their respective level indicating system, reflect the functioning of the limiter by lighting up for a relatively long or short period. Optimal record level has been set when one of the illuminated indicators flickers up only occasionally. Otherwise the record level must be lowered, using the appropriate level control. When the limiter switches on and off in rapid succession due to an incorrect record level setting, it creates a "pumping" or "breathing" effect that becomes noticeable through a swelling and receding of the background noise.

Pressing the LIMITER switch ⑦ a second time releases it into its up-position and switches off the peak level limiting circuit.

3.6 Mode Selector ⑧

Turning this switch sets the SG 631 LOGIC into MONO, STEREO or SLIDE operating mode. In quarter-track operation (using Tape Head Assembly Z 412), switching to MONO 1 position sets the machine for operation on track 1 or track 4. In half-track operation (using Tape Head Assembly Z 402) MONO 1 position switches to track 1. Always use level control © or ③ to set the mono record level that in turn, will be registered by the upper indicator of the level meter. Similarly, with the switch in MONO 2 position, track 2 or track 4 will be used in quarter-track operation and track 2 in half-track operation, with level controls CD or ③ used for setting the record level. The record level for MONO 2 operation, however, is registered by the lower indicating system of the level meter. During mono operation the level controls ② and ④ are not needed and should be faded out.

With this switch in MONO 1, MONO 2 or STEREO (quarter-track stereo operation using Tape Head Assembly Z 412) the full take-up reel may be exchanged with the empty supply reel for a second tape pass after the first pass has been completed and tape is completely on the right (or take-up) reel. In half-track stereo operation only one tape pass is possible; hence the tape should be rewound onto the left (or supply) reel once the tape is completely on the take-up reel.

In half-track operation slide synchronization may be only monophonic, but stereophonic in quarter-track operation. The differences between half-track and quarter-track operation as well as the location of the control track for slide projector operation are clearly shown in Fig. 4. Slide synchronization is possible only at the 9.5 or 19 cm/s (7½" or 3¾") tape speeds!

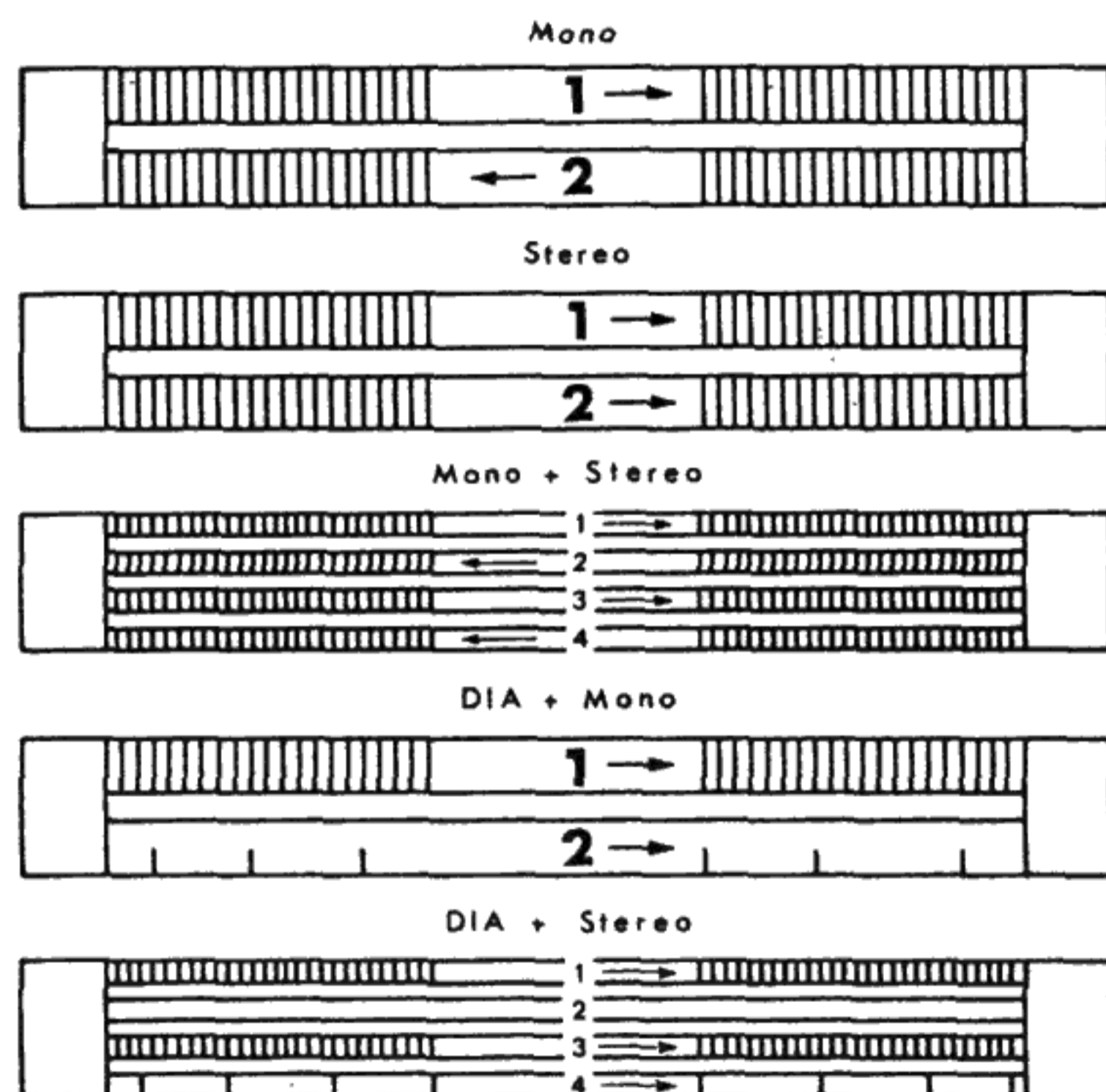

Fig. 4

3.7 MONITOR Switch ©

This pushbutton is for selecting "off-the-tape" ("B") or "from source" ("A") as the mode of monitoring during record. It allows the quality of the recording to be checked acoustically at once, during record, for in "B" position playback of the signal just recorded is directly off the tape. On the other hand, with "A" monitoring the signal delivered by the input source may be heard while it is being recorded on the tape. This direct comparison of source and tape recording lets differences between the two be easily recognized.

When the switch is in TAPE position, a green function indicator lights up while a red illuminated function indicator reflects the SOURCE monitoring position. Both function indicators are located above the MONITOR switch.

3.8 Tape Speed Selector ⑩

Turning this switch sets the tape speed at (4.7, 9.5 or 19 cm/s) 1⅞, 3¾, 7½ ips. As may be seen in the Performing Specifications at the end of the Operating Instructions, the highest quality demands are fulfilled at the 7½ speed. **Note:** Operation of automatic slide projectors and multi-vision projectors is possible only at tape speeds 3% or 7½ ips.

3.9 REC(ORD) Key ⑪

Pressing this key lightly sets the SG 631 LOGIC in record mode, and setting the record level may be undertaken at once. Make certain that the tape type selector is in the proper position (see also sec. 3.21).

When the RECORD key is engaged, the function indicator above it is lighted. Actual start of recording is begun by lightly pressing the START key (13) .

With the REEL-SIZE switch (27) in its neutral up-position the SG 631 LOGIC is set for (27 cm) 10½ spools. If tape on (13–18 cm) 5"-7" spools is used, press the REEL-SIZE switch into its down-position. The proper green function indicator above the switch lights up to show which reel size has been selected and set.

3.10 Rewind Key (12) ◀◀

Pressing this key lightly sets the machine for fast rewind. It may be activated directly from any other operating function setting. When the REWIND switch is operation, the green function indicator above it lights up.

3.11 START Key (13)

On lightly pressing the START key, the tape is formed into an OMEGA loop around the capstan, whereupon tape transport begins. The START key may be actuated directly from any other operating function setting. When the switch is engaged, the green function indicator above it lights up.

3.12 PAUSE Key®

Pressing this key lightly interrupts tape motion begun with actuation of the START key. Tipping the key a second time re-starts tape motion.

The green function indicator above the PAUSE key lights up when the key is engaged.

3.13 STOP Key (15)

Lightly pressing the STOP key disengages all deck functions described above. As long as the STOP key is engaged, the green function indicator above it will remain lighted.

3.14 Fast Forward Key (16) ••

Lightly pressing this key switches the SG 631 LOGIC to fast forward wind. It may be actuated directly from any other deck function setting. When the switch is engaged, the green function indicator above it lights up.

3.15 Counter with Zero Reset Button/Off-Switch for Automatic Shut-Off ©

Pressing the zero reset button cancels any given index number, returning the counter reading to "0000". Before each recording, it is advisable to press the reset button or note the starting index number.

Holding the button down switches off the automatic shut-off circuit that is normally actuated by the foil (transparent or metal) at the beginning or end of the tape. Then upon pressing one of the tape transport keys, the switching foil will move away from the switch-off contacts or light barriers.

3.16 POWER On /Off Switch ⑱

Pressing this lock-down pushbutton into down-position switches on the power supply of the SG 631 LOGIC. The level meter and the function indicator above the STOP key will then light up, as well as one of the two MONITOR function indicators and one of the function indicators for the reel-size switch. Pressing the POWER button once more switches off the power supply, and the button will return to its up-position.

3.17 Headphones Volume Control ⑲

This knob is for linear volume regulation of stereo headphones connected to the SG 631 LOGIC. Turn the knob clockwise to increase the volume, anti-clockwise to decrease it.

3.18 CUEING Switch ⑳

"Cueing" in the sense of "giving the signal or key-word to begin" gives the best idea of what happens in the CUEING process. A certain spot on a recorded tape is located in order to begin a new recording or to begin playback of a particular passage, or to edit (splice) tape: as is everyday practice in professional studio recording.

The approximate location of a particular spot on the tape can be accomplished by using the fast-forward or rewind modes plus the index counter. For exact location, however, switch the SG 631 to PAUSE and playback, then activate the CUEING switch (turn switch to position 1); the tape reels may then be turned by hand. Slowly turning the take-up reel with one hand while slightly braking the supply reel with the other permits the playback to be heard at relatively normal pitch.

3.19 "DIA" (Slide Control Pulse) Button ㉑

Pressing this button will record a slide-changing pulse (1 .kHz) on the control track of the tape if the mode selector ⑧ is set to DIA (to switch on the control signal generator) and the RECORD key ⑪ has been actuated.

3.20 OUTPUT LEVEL Control ㉒

Turning this switch sets the output signal delivered to the RADIO socket and permits matching the output level of the SG 631 LOGIC to that of a second sound source when connected to an amplifier not equipped with a variable input level control. With the volume control of the amplifier in the same position when switching from tape playback to, for example, phono playback, the volume level should remain unchanged. With the output level control in middle position, an output signal of 750 mV per channel is delivered to the RADIO output socket. Turning the level control clockwise raises the output voltage (up to approximately 1.2 V per channel). Turning it anti-clockwise lowers the output signal (down to approximately 500 mV per channel).

3.21 TAPE SELECT Switch ㉓

Turn switch to set the machine to standard ferric oxide tape (Fe-position) or to ferrichrome tape (FeCr-position). The latter has two magnetic coatings and a high frequency output of approximately 4 dB better than that of standard tape.

3.22 Stroboscope Discs 50 Hz (24) and 60 Hz (25) _{fc}

The 50 Hz stroboscope disc is incorporated into the tape tension sensor of the supply reel while the 60 Hz disc is on the sensor of the take-up reel. Under artificial light and at a mains frequency of 50 Hz, the line segments on the left stroboscope disc will appear to be standing still if tape motion is at the exact speed of 7½ ips. The line segments will seem to rotate slowly if the tape speed is slightly inaccurate. The same holds true for the stroboscope disc on the right tape tension sensor (of the take-up reel) at 60 Hz and under artificial light.

The stroboscope is a highly precise indicator that permits recognition of the very least deviation from the nominal tape speed. Very slight stroboscopic deviations are, therefore, of no practical significance.

When the stroboscope seems to turn anti-clockwise, tape speed is too high; when it seems to turn clockwise, the speed is low.

3.23 Find Speed Adjuster (7½ ips) / Pitch Control (26)

When the tape speed selector set to 19 cm/s, this control may be used to adjust the speed by approximately $\pm 4\%$. The pitch of the recording will thus also be altered by $\pm 4\%$. In general, it is necessary and advisable to alter the tape speed only when playing tapes recorded on other machines or when, for example, the pitch of a recording made with your SG 631 must be adjusted to that of a musical instrument. As a matter of principle, of course, recordings on your SG 631 should be made at the nominal speed. Consequently, after altering the tape speed, do not forget to reset the speed to exactly 19 cm/s (7½ ips), using the stroboscope to assure accuracy. Fine speed adjustment should be made only after the machine has warmed up (allow at least 10 minutes after switching the power on) so that any slight drift during the warming-up period

may be taken into consideration. With the fine control in "0" position, the 7½-ips speed will be within the margin of tolerance permitted by German DIN standard 45500.

3.24 Reel-Size Switch

When using reels up to 7" in size, press this pushbutton into its lower, locking position. The green function indicator "5-7" will light up. If two 10½" reels are used, the switch should be set to "10½". It will then be in its up-position and the green function indicator "10½" will light up. (Always use two reels of the same size!)

4. Record Operation for True Audio Enthusiasts

4.1 Input and Output Connections

Input and output devices should be connected as described in secs. 2.1, 2.5 and 2.6 (or 2.11 and 2.12). If, while seeking the correct setting for maximal record level of an input source connected to the RADIO input, it is found that the level controls (3) and (4) must be kept just barely opened in the lowest part of the scale range, check whether connecting the input source to the PHONO input would lead to better recording conditions. Contact assignment and input impedances would have to be taken into consideration, and a crossover adapter (pin 1 is cross-connected with pin 3, pin 4 with pin 5), obtainable from your audio dealer, would have to be inserted into the PHONO socket. The procedure is conversely similar when input sources are connected to the

PHONO input and level controls ③ and © must be kept turned up full in the highest part of the scale range. If you have difficulty in solving such connecting problems, kindly consult your audio dealer.

4.2 Power Supply

When first connecting the SG 631 LOGIC, particular attention should be given to the instructions and comments found in sec. 1.4. **Never forget to disconnect the power supply lead from the mains power outlet before changing the fuse or resetting the voltage.** The plug must also be taken out of the mains outlet before cleaning the SG 631 LOGIC with a moistened cloth.

If the power supply is completely in order, the level meter and the function indicator above the STOP key must light up once the POWER switch ⑱ is pressed. In addition, the function indicators for "A" or "B" monitoring and for reel-size "5-7" or "10½" must light up, according to the control settings. The D.C. fuses, which are not accessible from outside the machine's housing, should be changed only by a service technician as the cause of the defect must first be removed.

Even extremely brief overloading and internal short-circuiting are detected by an electronic guard circuit that immediately switches off the power supply. Pressing the POWER button ⑱ off and on again will switch the power supply back on if the D.C. fuses are still intact.

4.3 Preparing to Record

All preparatory steps prior to actual recording should be carried out with great care. They will be easier to remember if they are always executed in the same order.

After first mounting the NAB adapters and/or the reels, then threading the tape (see sec. 1.6), make certain that the reels are securely locked onto the spindles and that the right switches for tape type (switch ⑳) and reel-size (switch @) have been activated (see also secs. 3.21 and 3.24).

In selecting the tape speed, the frequency response of the input source to be used and, under certain circumstances, the duration of the recording, should be decisive. The highest frequency an FM station can transmit is 15 kHz. In reality, however, broadcasts rarely exceed 12.5 kHz. The highest frequency obtainable from a high-quality microphone is approximately 20 kHz. The same is true of new, high-quality phonograph records. As speed deviations between two tape recorders may be balanced out - but also added together - in dubbing, it is advisable to set the recording machine at the highest tape speed whenever possible. The advantages of doubling tape use or of stereophonic sound, for slide showings or film dubbing, which may be achieved through quarter-track recording are juxtaposed by an improvement of approximately 3 dB in the signal-to-noise ratio and the possibility of editing (splicing) the tape when recording with the half-track stereo configuration.

Before starting to record, careful thought should be given to all of these factors and, if necessary, test recordings made for evaluation.

4.4 Making Record Level Test and Starting to Record

Making a record level test means adjusting the record level - without tape motion - before starting to record. The test can be made upon simply pressing the RECORD key ⑪ lightly. A more practical procedure is, however, to actuate the RECORD ⑪, PAUSE © and START ⑬ keys one after the other once the tape has been threaded and wound onto the take-up reel past the switching foil (see sec. 1.6). The SG 631 LOGIC

is then set up to record, releasing the PAUSE key permits actual recording to start immediately after completing the level test.

Before commencing to record, it is always advisable either to note the counter index number or to press the zero reset button in order to facilitate location of the beginning of the recording upon later tape rewind or playback (see sec. 3.18).

Once all of these steps have been completed, the input source to be recorded should be faded in via the master control (5) and, using level controls (6) and (7) or (3) and (4), adjusted for maximal record level at the loudest passages (see secs. 3.1 to 3.4). The peak level limiter (8) may then be switched in-circuit (see sec. 3.5), and releasing the PAUSE key (14) (to up-position) will start actual recording. By switching the MONITOR switch (9) (see sec. 3.7) from TAPE to SOURCE, you may also acoustically judge the quality of the recording. Headphones must be connected as described in sec. 22 (for their volume regulation see 3.17), or monitoring must be through the loudspeakers of your sound system (see sec. 5.1).

5. Playback Operation for True Audio Enthusiasts

5.1 Playback through Hi-Fi Sound System Amplifier

Amplifiers with DIN socketry should be connected to the RADIO socket of the SG 631 LOGIC via UHER Stereo Lead K 541.

Amplifiers with phone sockets may be connected to the RADIO socket of the SG 631 LOGIC via UHER Lead K 551. On the sound system amplifier use the left and right tape inputs. Before connecting up the equipment, note the lead end markings: yellow for the left channel, red for the right channel.

For playback the MONITOR switch (9) on the SG 631 LOGIC must be in TAPE position. Set volume, tone and channel balance in accordance with the operating instructions for your amplifier. The playback (or output) signal delivered to the RADIO socket may be raised or lowered by turning the OUTPUT LEVEL control (22). Thus the tape recorder signal may be adjusted to permit switching to other input devices (like a record player) connected to the amplifier without a change in volume (see also sec. 3.20).

If your amplifier is equipped with a monitor input, the input may be used for monitoring as described in sec. 6.2.

5.2 Playback through Stereo Headphones

All high or low impedance stereo headphones with an impedance between 8 and 2,000 ohms may be connected directly to one of the two headphones sockets if they are equipped with 5-pin plugs. Headphones with LS-7 plugs require UHER Adapter K 633 for connection to the sockets. To connect stereo headphones with jack plugs, you will need special adapters which are available at audio dealers' everywhere. When using these adapters, you may find that the playback of a stereo recording is monophonic. In such case, pull the 5-pin plug of the adapter out of the headphones socket and turn it 180° before re-plugging it into the socket.

The volume may be regulated by turning the headphones volume control (19) as described in sec. 3.17. The output signal (which may be adjusted with this control to approximately 1.5 V per channel) delivered to the headphones socket permits connecting self-energized loudspeakers which achieve particularly high acoustic output. Self-energized loudspeakers should be connected the first time by your audio dealer or an audio technician.

6. Further Hints and Tips

6.1 Transcribing onto Another Tape Recorder (Dubbing)

Without having to alter stationary connections to your sound system, recordings may be copied onto another open-reel (or cassette) recorder by using the DUBBING socket. UHER Stereo Lead K 541 should be used to connect the SG 631 LOGIC to the RADIO socket of the other recorder. (The output level control ② does not affect the dubbing output.)

6.2 Monitoring via the MONITOR Output

If the power amplifier of your sound system has a monitor input, you may use the system's loudspeakers for acoustic monitoring of your recording by connecting the MONITOR socket of the SG 631 LOGIC to the MONITOR input of the amplifier (UHER Stereo Lead K 541 will be needed). Switching for off-tape or from-source monitoring may be accomplished either from the tape recorder or from the amplifier. When switching from the tape recorder, the monitor switch of the amplifier must be pre-set for off-tape monitoring. On the other hand, to use the amplifier's switch to select the mode of monitoring, the monitor switch of the SG 631 LOGIC must be in TAPE position.

6.3 Sound for Slide Shows

Sound for a slide show and the control pulses that trigger slide change should be recorded separately. When working with the half-track tape head assembly (Z 401), only monophonic recording is possible as the

control pulses must be recorded on the lower track (see Fig. 4 "SLIDE + MONO") of the tape. Moreover, during playback through the power amplifier of a hi-fi system the volume of the control track channel must be turned down to zero in order to render the 1 kHz control pulses inaudible. On the other hand, if the quarter-track tape heads (Mount Z 411) are used, sound for the slide showing may be stereophonic (see Fig. 4 "SLIDE + STEREO"). It should be noted that only tape speeds 3% or 7½ ips may be used for recording the sound and control tracks for slide shows. Before starting to record, write a script detailing the order in which the slides are to be shown together with the commenting texts and the background music to be employed. Referring to the script, you may use the master control (5), when recording, to fade in and out the microphone input for the spoken comments and the radio or phono input for the musical background. To fade over from the microphone input to the radio or phono input, evenly turn the level of the microphone input down to zero (the mid-position of the master control) and evenly increase the level of the music input from zero to the full strength desired. If the spoken commentary is to be accompanied by a soft musical background, a mixer (like UHER Mix 500 A 124) must be used. Connect the mixer via UHER Stereo Lead K 541 to the RADIO socket of the SG 631 LOGIC. Read the instruction manual enclosed with the mixer for instructions on using mixer controls to fade inputs in, out and over. To check the order of the slide series, slide changing may be manually signalled while recording. With automatic slide projectors slide changes may be signalled with the projector's remote control unit, however.

Once the recording of the sound track has been completed, the tape should be rewound and the slide magazine of the projector returned to its beginning position for recording the control track.

Procedure:

First turn the mode selector (8) to SLIDE and connect (via UHER Lead K 911) the SLIDE socket of the SG 631 LOGIC to the remote control socket of the slide projector. Then actuate the RECORD (11), PAUSE (12) and START (13) keys, one after the other. When the projector has been switched on and the PAUSE key (14) has been disengaged to start tape motion, press the SLIDE pushbutton (21) to record the first control pulse which, in turn, will project the first slide picture into view. After this point, the SLIDE pushbutton (21) should be pressed during playback of the sound track whenever the slide is to be changed - that is, whenever a control pulse is to be recorded on the tape to trigger the projector to change the slide automatically during subsequent playback. When all of the slides have been run through, rewind the tape and return the slide magazine to its starting point once more. Now your SG 631 LOGIC can take over the presentation of your slides, automatically operating the slide projector. But remember: the mode selector must be in DIA position.

All of the recorded control pulses may be erased without affecting the sound track if the tape is played through with the mode selector set to DIA and the RECORD key actuated.

6.4 Recording with UHER Telephone Adapter A 261

UHER's galvanic Telephone Adapter A 261 should be connected to the RADIO socket of the SG 631 LOGIC. Connecting the adapter to your telephone is a matter for the postal authorities (or telephone company). During record, the mode selector may be set at either MONO 1 or MONO 2. It is advisable to make a "test" telephone call in order to make a record level test, marking or remembering the setting of the level control. The procedure for making the recording itself is described in sec. 4.

6.5 Erasing Only

Whenever the recorder is operating in record mode, any previous recording on the tape is automatically erased. For erasure only the SG 631 LOGIC should be operated just as for record but with the master control (5) in its middle click-position at which all input sources remain out of circuit.

6.6 Changing Tape Head Assembly Z 401 or Z 411 (See Fig. 6)

The procedure is as follows:

1. Switch the SG 631 LOGIC to STOP so that the tape may be lifted out of the threading slot.
2. Withdraw the front cover cap.
3. Loosen the knurled nuts (A) by rotating to the left, and remove.
4. Pull tape head mount (B) straight up and off.
5. Push the replacing tape head mount down into place; then secure it with the knurled nuts, rotating them to the right.
6. Replace front cover cap.

6.7 Azimuth Adjustment of Playback Head

In hole (C) of the tape head mount there is an adjusting screw with which the playback head may be tilted, within limits, to the left or right of its normal perpendicular position so that the SG 631 LOGIC may also play tapes recorded on machines with non-standard record head positions. The adjustment should be made with a non-magnetizable screwdriver, until achieving the best reproduction of high frequencies. Before adjusting the azimuth, however, make certain that the playback head surface is free of deposits of tape coating or dust. As poor correspon-

dence between record and playback head gaps results in a loss of high frequencies during playback - and the loss is even greater the wider the audio track is and the slower the tape speed - correction of the azimuth of the playback head will usually be required only for half-track recordings and at tape speeds of 3% or 7½ ips. If the adjustment does not lead to improved high frequency reproduction, then the record head of the other recorder may have been heavily clogged or worn. If sound system loudspeakers are used to monitor the adjusting process, the treble control on the power amplifier of the system should be opened up in full.

For record/playback of recordings made with the SG 631 LOGIC, the factory-set length of the playback head gap should be restored.

6.8 Putting On the Transparent Dust Cover Z 630

At its two upper corners UHER Transparent Dust Cover Z 630 has supporting plates with ridges that must be pressed into the top ventilating slits of the SG 631 LOGIC when the machine is in upright position. To bring the supporting plates into position over the ventilating slits, they should be lightly pressed outwards. Once fully pressed down into the slits, the plates will lock firmly in the groove between the upper and lower sections of the housing. On opening or closing the lid, it will remain in any intermediate position in which it is placed.

6.9 Operation of the SG 631 LOGIC with UHER Timer A 403

The timer will switch on the power supply for the SG 631 LOGIC as described in the operating instructions for the timer. For recording, thread the tape as described in sec. 1.6 above and press the POWER switch (18) into its lock-down position. The switch of the UHER-Adapter K 642 (which must be connected to the ACCESSORY socket of the

tape recorder) must be closed.

If a timer is to regulate a recording, a record level test should be made before the power supply of the input source is switched on via the timer. Once the timer has switched on the power supply of the input source and that of the SG 631 LOGIC, the start switch of the timer will switch the recorder to the functions RECORD and START, and the recording will commence.

If, for special cases, you would like to have "playback - Start" switching, kindly consult your nearest UHER service agent who will then make the necessary changes in your adapter.

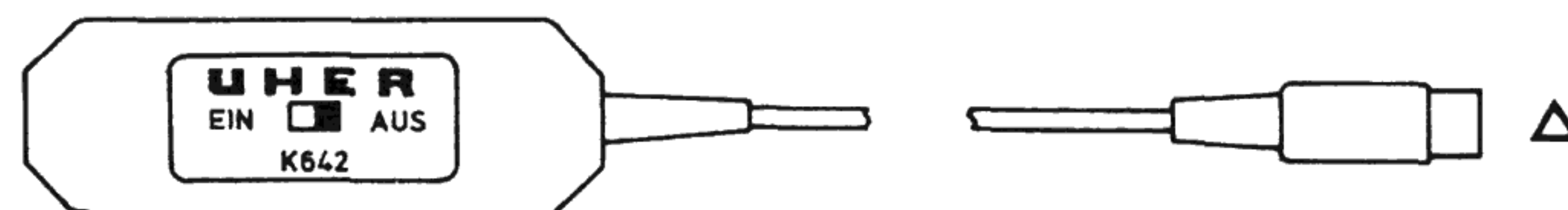

UHER K 642

Startschalter

Fig. 5

6.10 Tapes and Reels

The quality of the tape used is just as essential to high quality in recording as the quality of the recording equipment. More and more brands of tapes are being found among the wide assortment on the market that have greatly differing mechanical and electro-acoustical properties. That is why UHER has now added to its supply programme blank tape with characteristics that match, and in some points surpass, the properties of German DIN test tape C 264 Z: UHER "professional" tape Z 830. The base material is stretched polyester plastic with a black anti-static coating that was especially developed for fast-winding machines. The

iron oxide magnetic layer is characterized by its low noise and high output. UHER blank tape Z 830 is supplied on a precision-tooled metal reel with NAB adapter, reel size 27 cm (10½"), length of tape 1,275 m. It has red and green leaders (12.5 m) and two 26-cm stretches of transparent foil for photo-sensitive electronic end-of-tape switch-off as well as two 20-cm stretches of metallic foil for electronic end-of-tape shut-off.

Particular attention should be given to the type of reels used. You should always use two identical reels of the same size (and material) to prevent the danger of spilling on braking tape transport.

7. Care and Maintenance

7.1 Cleaning Tape-Touching Parts (See Fig. 6)

Since all important bearing points are equipped with self-lubricating sintered metal bearing bushes, the SG 631 LOGIC does not require oiling during its entire service life. Care and maintenance in the main are restricted to checking and cleaning at regular intervals. Our service agents should be consulted for this task.

The cleaning of the tape-touching parts (that may be needed from time to time - you may recognize the necessity on noticing a deterioration in playback quality, particularly of the high tones) can easily be performed by the user himself. For this purpose, first pull the cover cap in front of the head mount up and off. The magnetic heads (D), (E), (F) and (G); the tape guides (H), (I), (J) and (K), the reversing pins (L), (M), (O), (P) and (Q) will then be easily accessible and clogging deposits of dust and tape coating may be removed by means of UHER Special Cleaning Kit Z 172. **Caution:** The plastic coating of the capstan should be cleaned only with a cloth dampened in alcohol.

The SG 631 LOGIC is a highly developed precision machine; its trouble-

free operation depends upon the exact co-functioning of its mechanics and electrical components. In designing these important parts, attention was given to obtaining the highest degree of operational reliability and long serviceability. Should malfunctions appear at any time, we recommend consulting an experienced technician, for experience has shown that he will best spot and correct the difficulty (that will usually be of a minor nature). We warn strongly against any tampering by non-technicians as it generally results only in still greater damage.

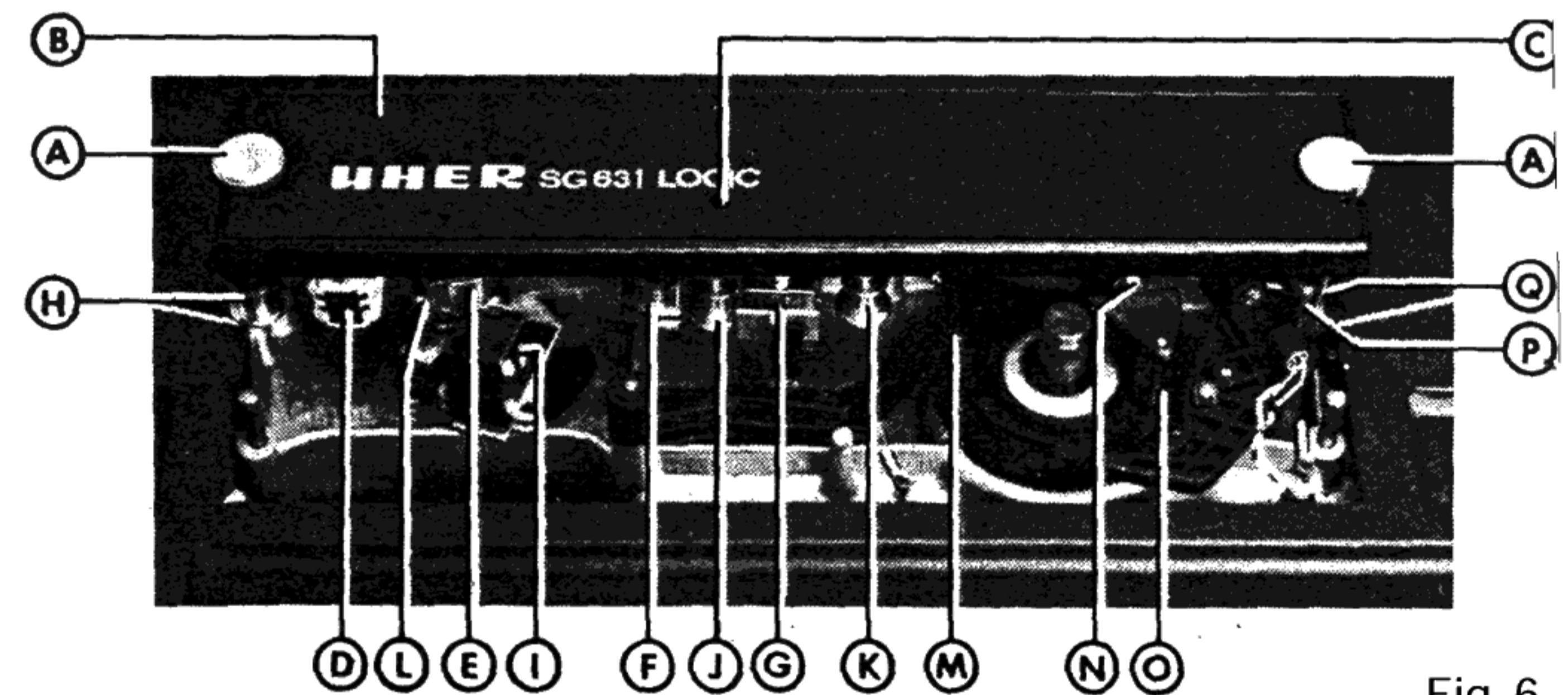

Fig. 6

7.2 Cleaning the Housing

The housing of the SG 631 LOGIC should always be cleaned with a soft, moistened cloth so as to avoid build-up of static charges. It is a well-known fact that a statically charged object strongly attracts dust. If the housing is particularly dirty, a mild dishwashing detergent may be added to the water.

Caution!

Before cleaning the housing with a moist cloth, do not fail to disconnect the SG 631 LOGIC from the mains outlet.

Performance Specifications

Track System:	Quarter-track or half-track due to interchangeable tape head assemblies
Tape Speeds:	7½, 3%, 1% ips, (19, 9.5, 4.75 cm/s)
Counter:	4-digit, with zero reset button and automatic foil shut-off device
Max. Spool Size:	10½" (27 cm)
Drive System:	2 D.C. hub motors; 1 collectorless, electronically controlled motor for capstan drive 1 servo-drive motor for forming the OMEGA loop.
Inputs:	Microphone 0.1- 80 mV 2 kohms Radio 1.0-200 mV 20 kohms Phono 80 mV - 8 V 680 kohms
Outputs/Output Voltages and Impedance	Radio approx. 750 mV 15 kohms Monitor approx. 750 mV 15 kohms Headphones approx. 1.7 V 120 kohms Dubbing 700 mV 15 kohms
Power Amplifier:	Stereo headphones power stage with volume control
Record Level Indication:	Moving-coil peak-reading meter
Overall Frequency Response:	V/a ips 20-10,000 Hz 3¾ ips 20-16,000 Hz 7½ ips 20-25,000 Hz
Harmonic Distortion (at 333 Hz and 7/2 ips):	For max. record level of tape (approx. + 1.5 dB): 3% For 0 dB meter reading: 1%
Crosstalk (at 1 kHz and oppositely running dual-track mono recording):	Better than 60 dB

Crosstalk (at 1 kHz in Stereo Operation):	Better than 45 dB		
Crosstalk (at 1 kHz and Two-Direction Stereo Operation):	Better than 60 dB		
Signal-to-Noise Ratio (ref 0 dB, unweighted):		¼-track	½-track
	7½ ips	56 dB	58 dB
	3% ips	55 dB	57 dB
	1⅞ ips	53 dB	54 dB
Signal-to-Noise Ratio (ref 0 dB, "A" weighting):		¼-track	½-track
	7½ ips	65 dB	68 dB
	3¾ ips	64 dB	67 dB
	1⅞ ips	63 dB	67 dB
		} DIN	
Wow and Flutter:			
	1⅞ ips	max. 0.2 %	
	3% ips	max. 0.1 %	
	7½ ips	max. 0.05%	
Max. Speed Deviation (Mid-Spool) at 7/2 ips	±1.5%		
	Adjustable to 0 % with fine regulator; stroboscope discs 50 Hz and 60 Hz for optical control		
Erase:	Better than 72 dB		
Bias and Erasure Frequency:	100 kHz		
Attenuating Effect on One Track upon Erasure of Other:	Less than 1 dB (at 15 kHz, 19 cm/s)		
Transistors and Semi-Conductors:	Transistors: 111 (including 13 FET) IC: 19 Diodes and Rectifiers: 143		
Power Supply:	A.C. 110/130 V, 220/240 V 50/60 Hz		
Dimensions:	20V2" x 6" x 16" (510 x 146 x 400 mm)		
Weight:	28½ lbs. (13 kg)		

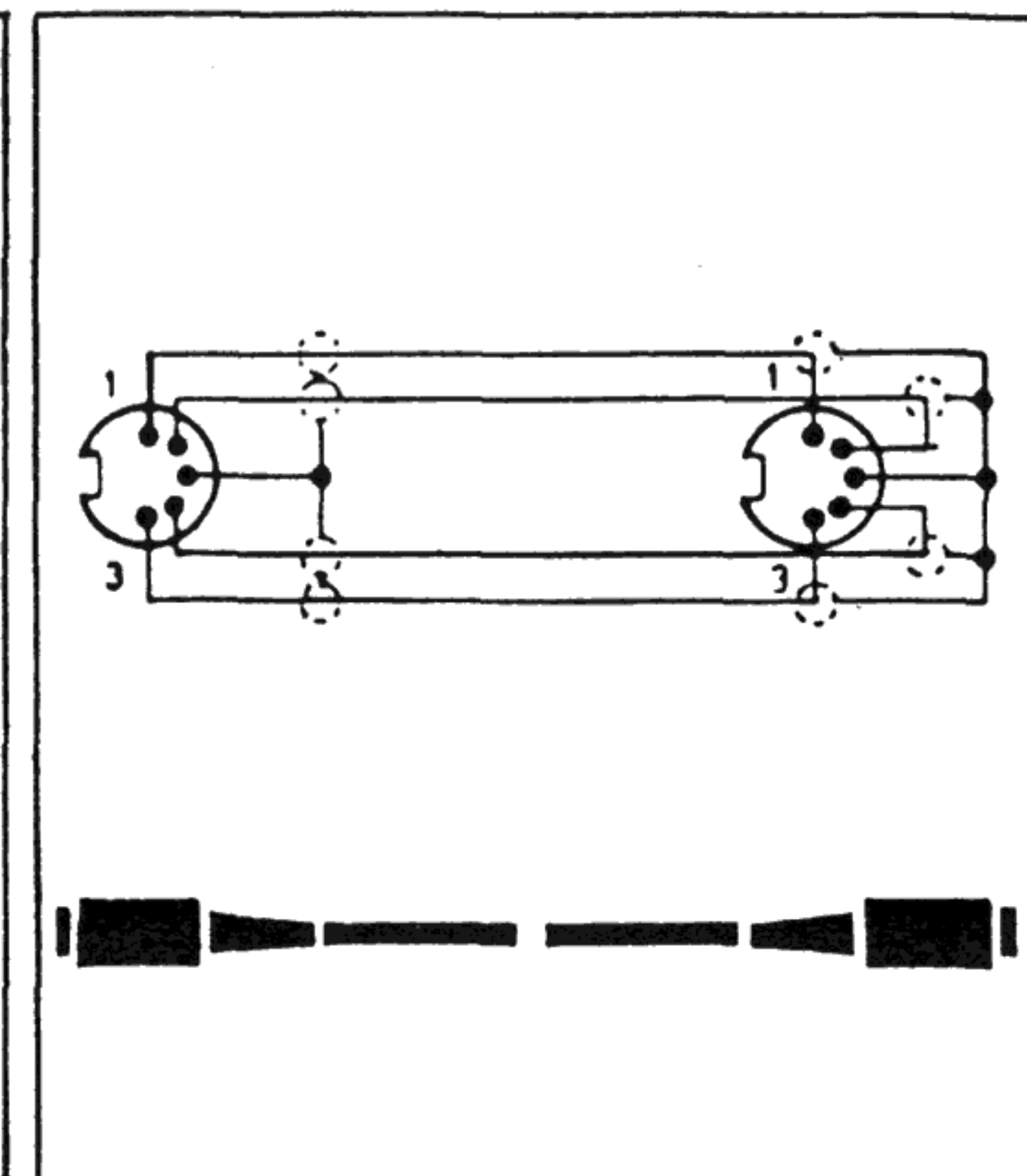
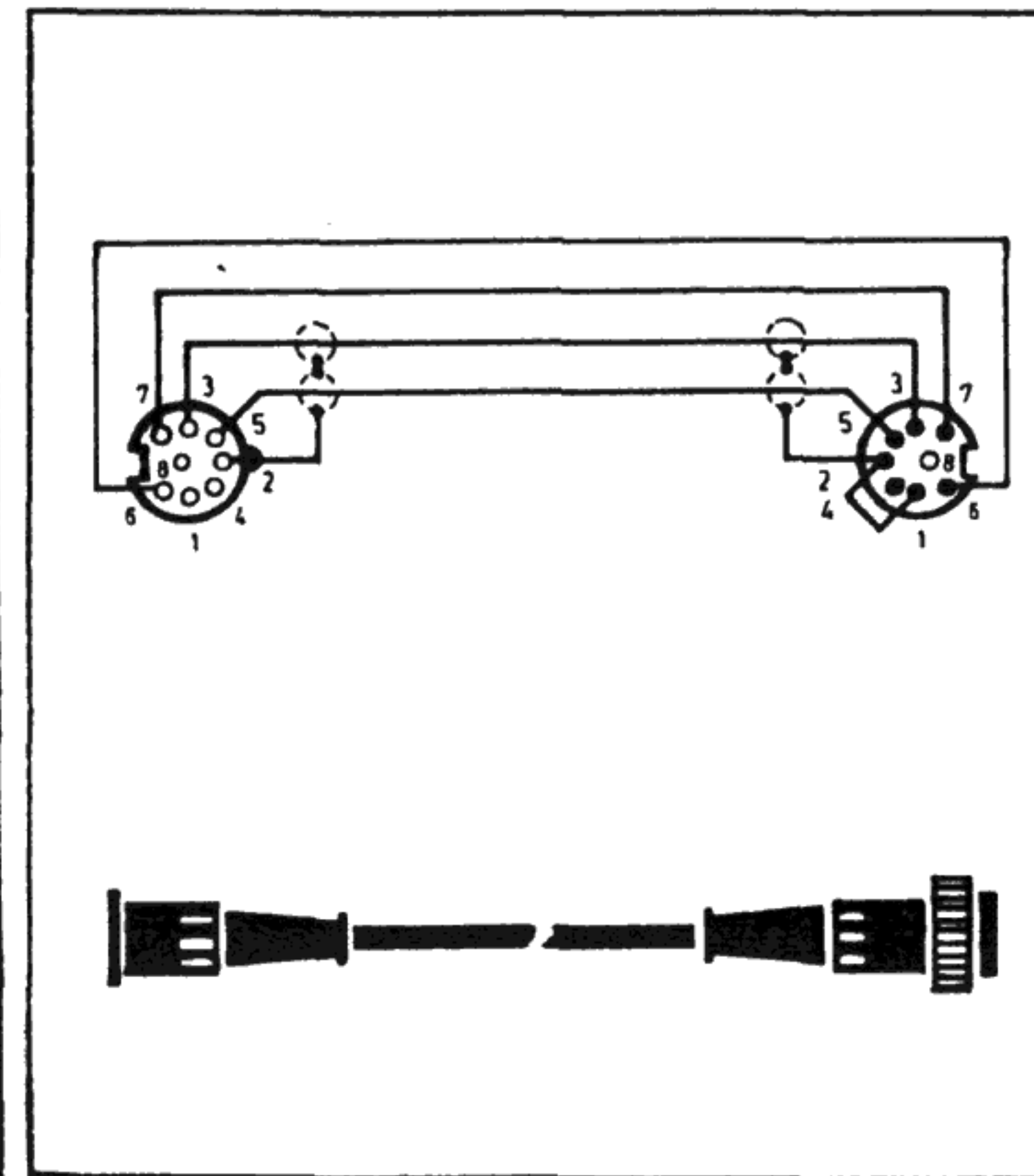
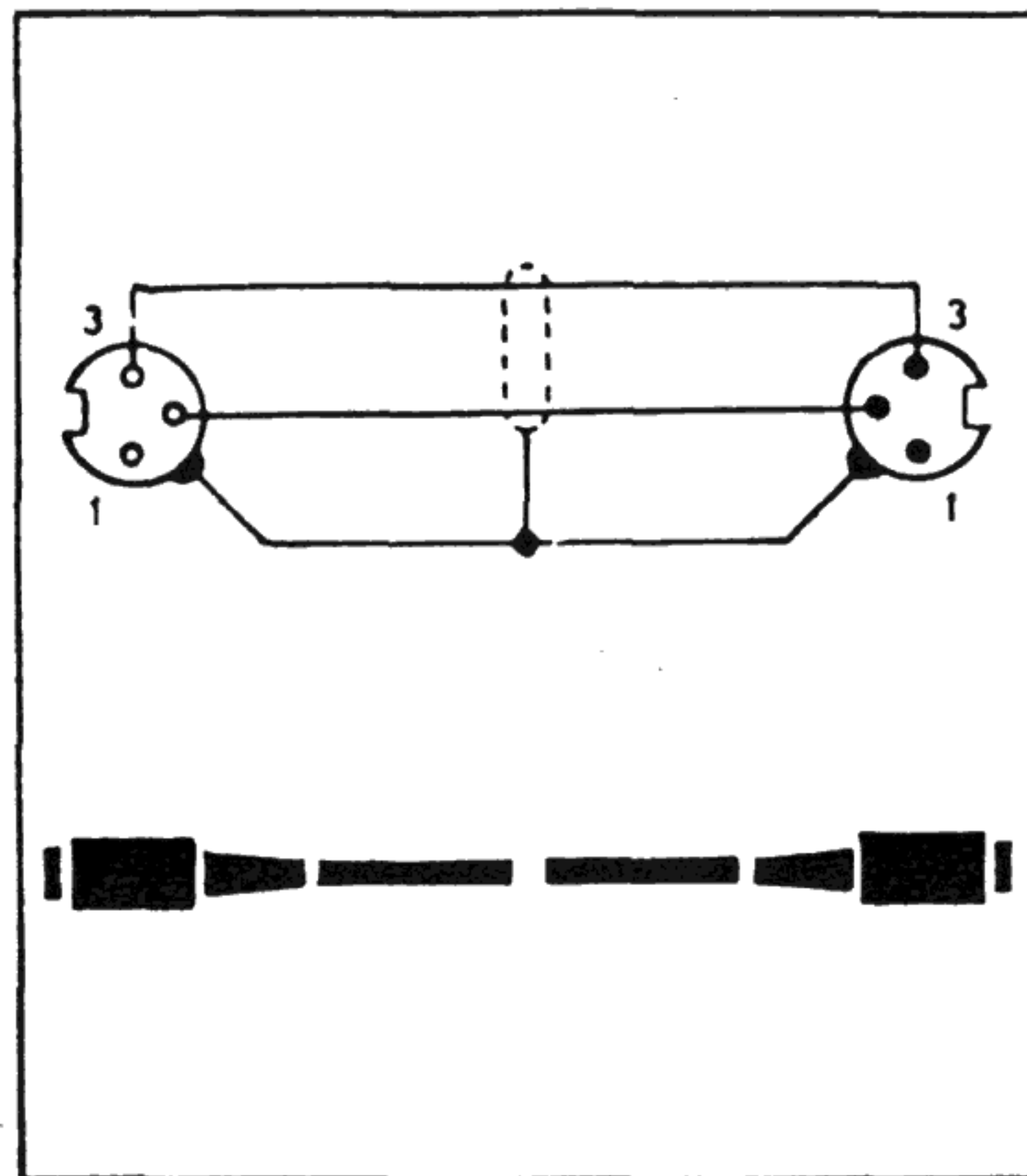
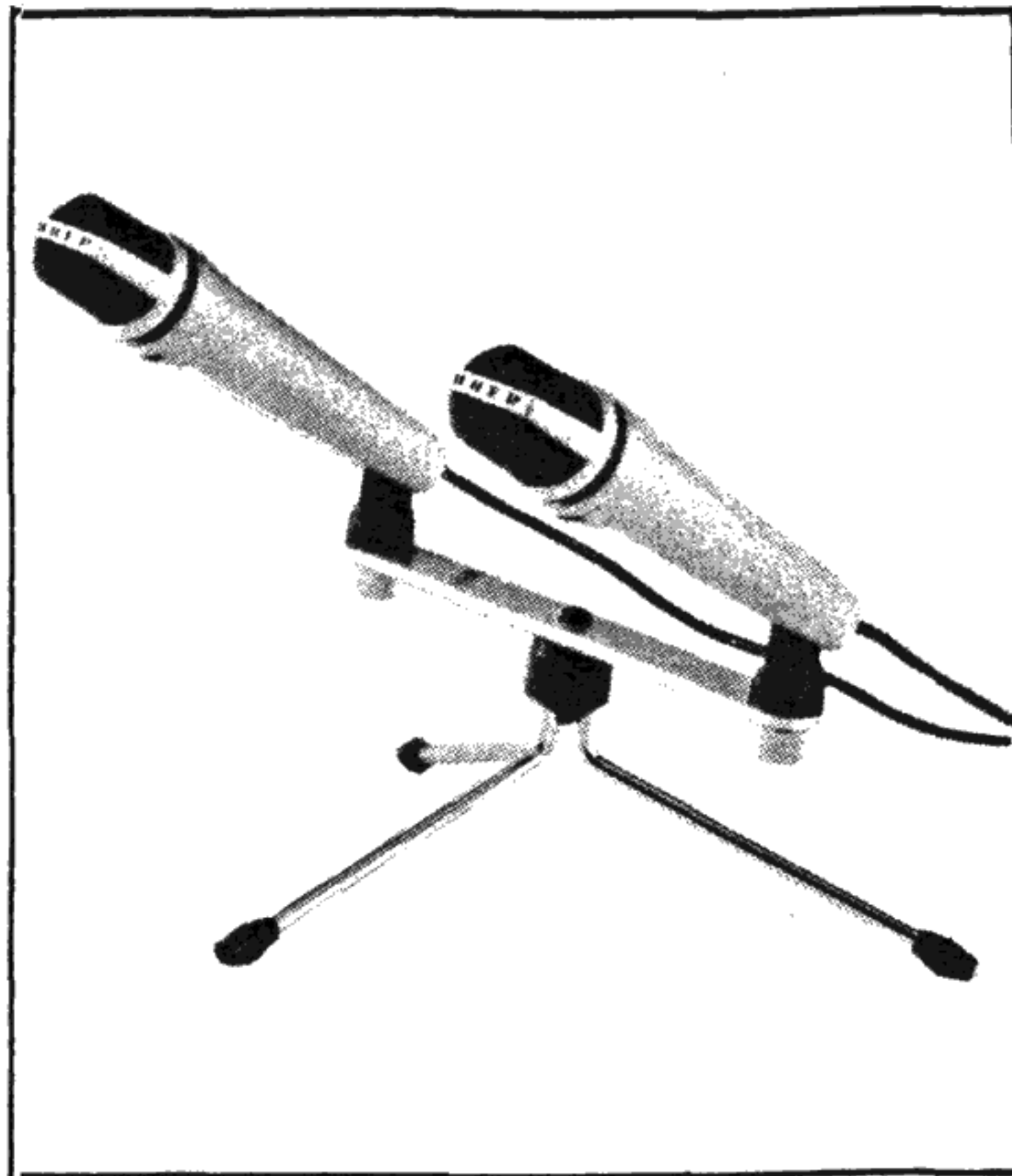

M 634

K 110

K 134

K 541

M 634 (= 2 M 534 - 2 K 110)

- K 626 - SG 631 LOGIC

M 640 - (K 134) - SG 631 LOGIC

2 M 517 - (2 K 110) - K 626

- SG 631 LOGIC

2 M 645 - K 626 - SG 631 LOGIC

M 517 (Mono) - (K 629)

- SG 631 LOGIC

M 645 (Mono) - (K 621 - K 110)

- SG 631 LOGIC

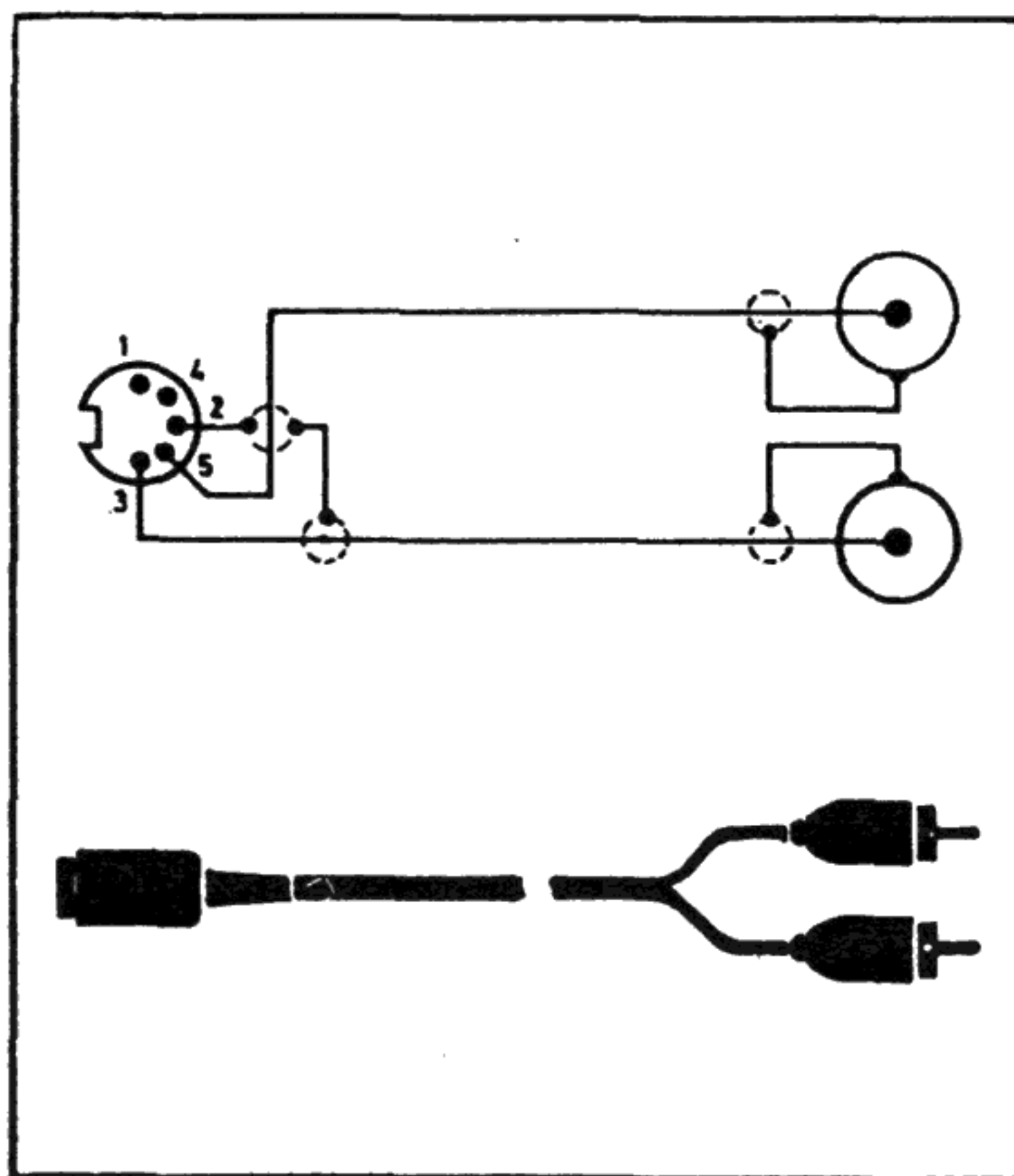

K 551

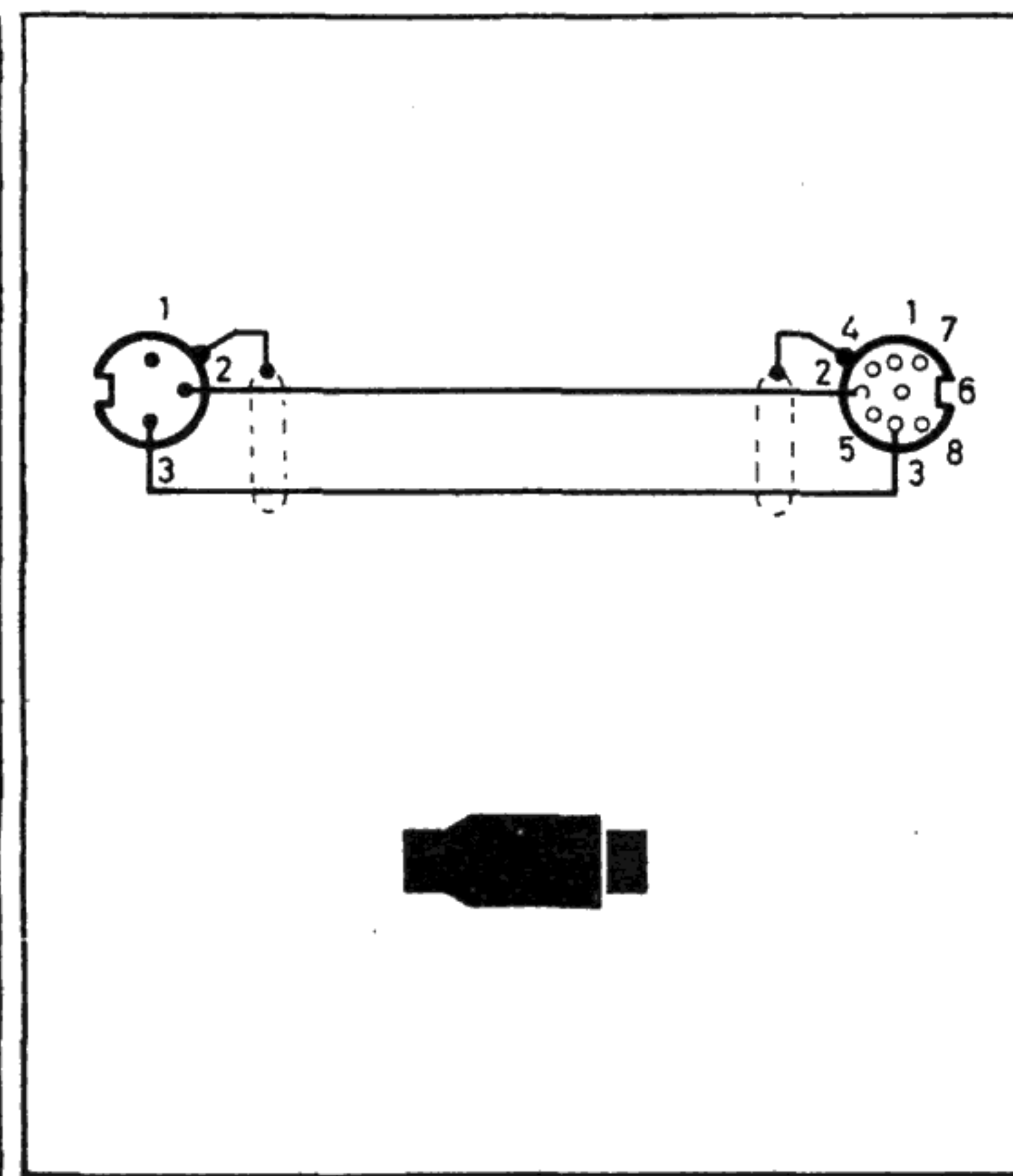

K 621

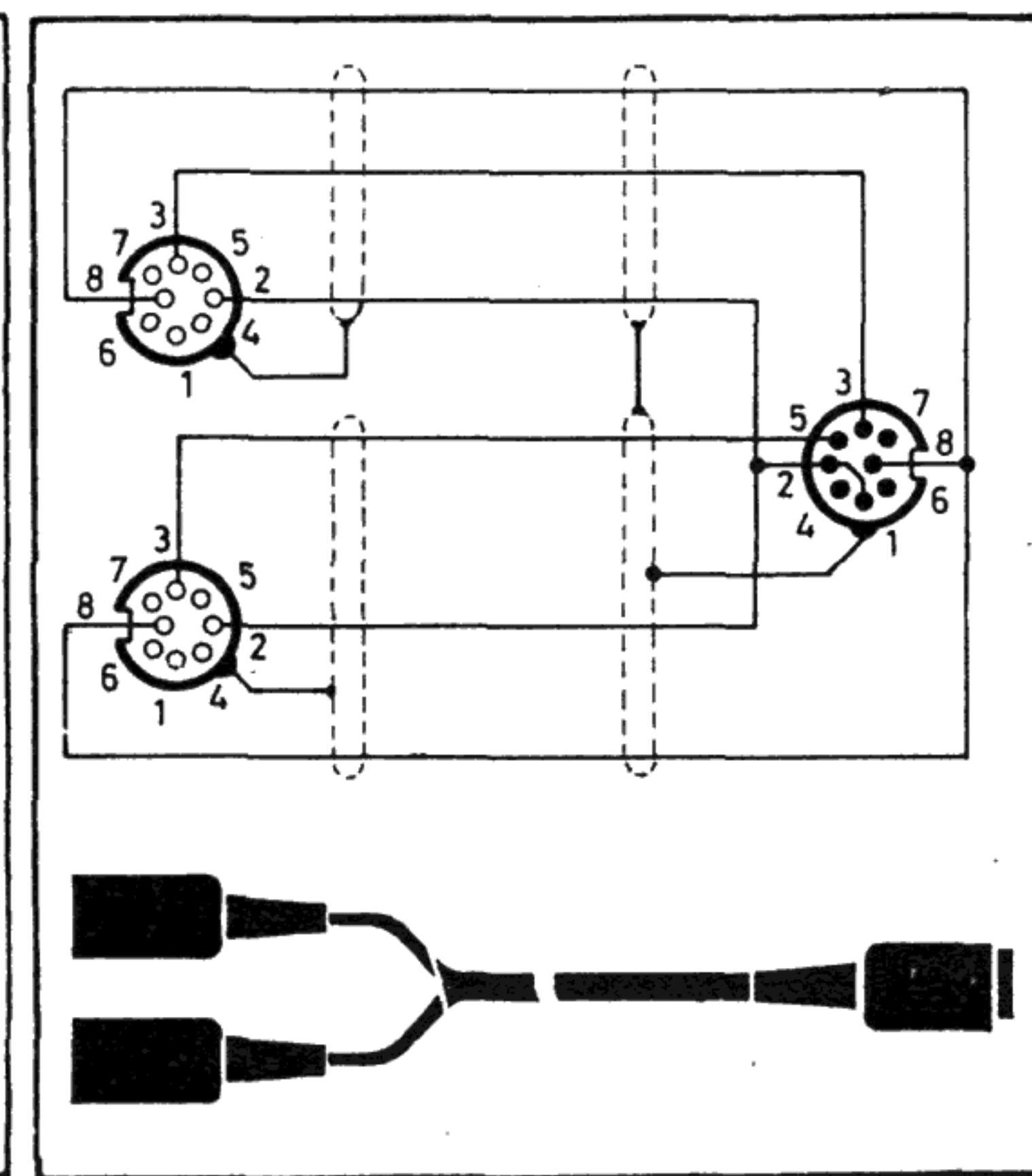

K 626

Änderungen, die dem technischen Fortschritt dienen, und Liefermöglichkeiten vorbehalten.

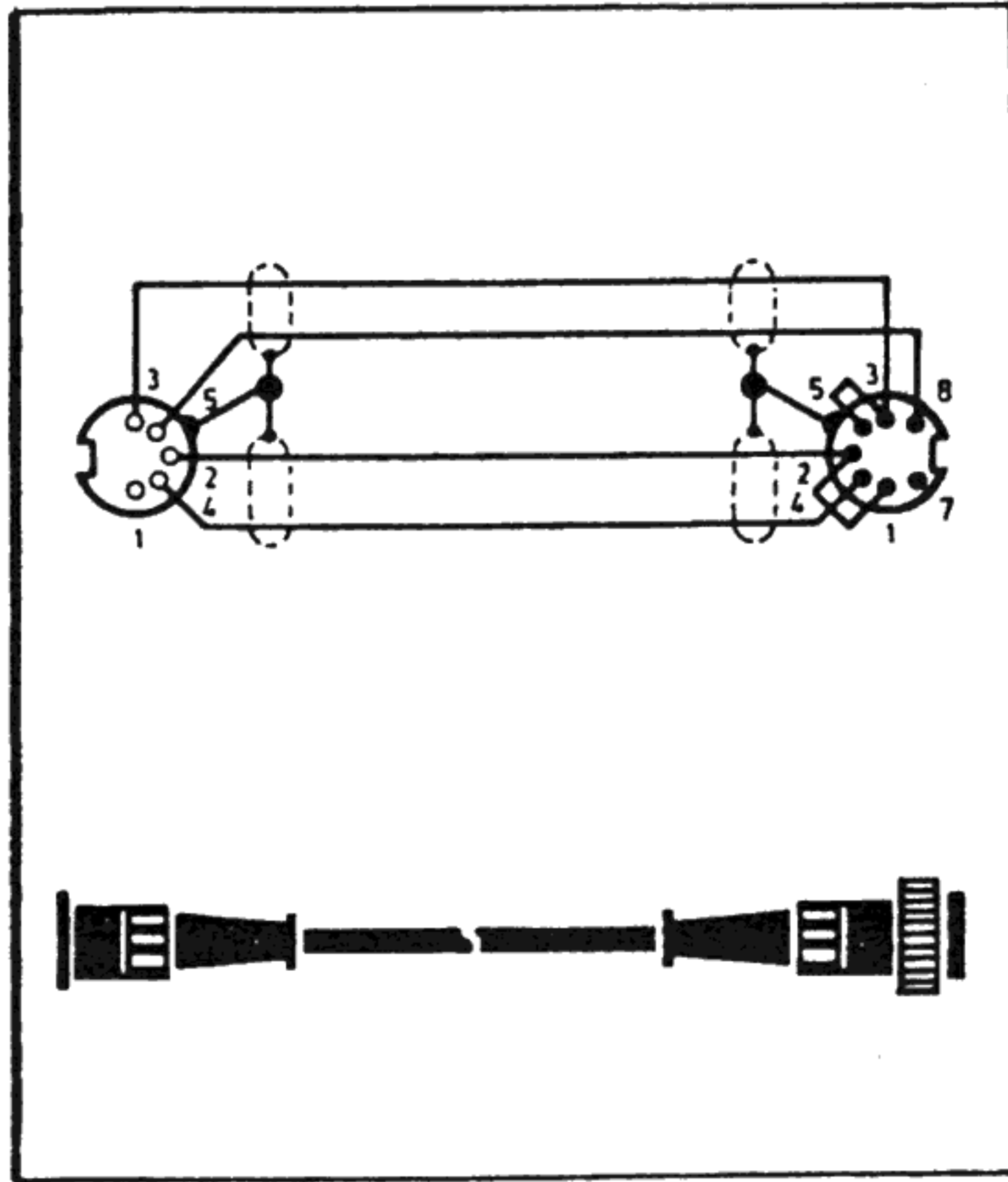

K 629

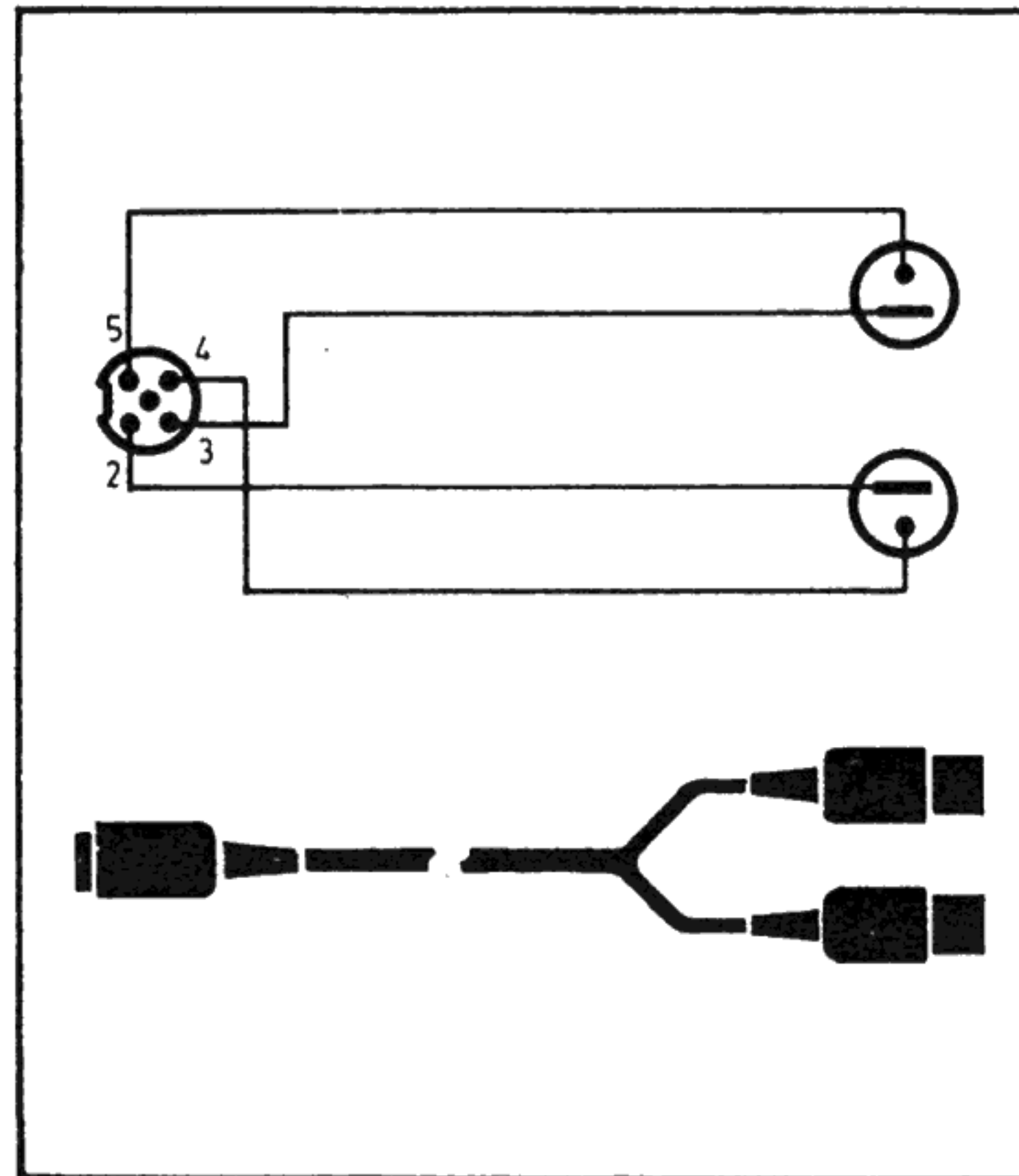

K 633

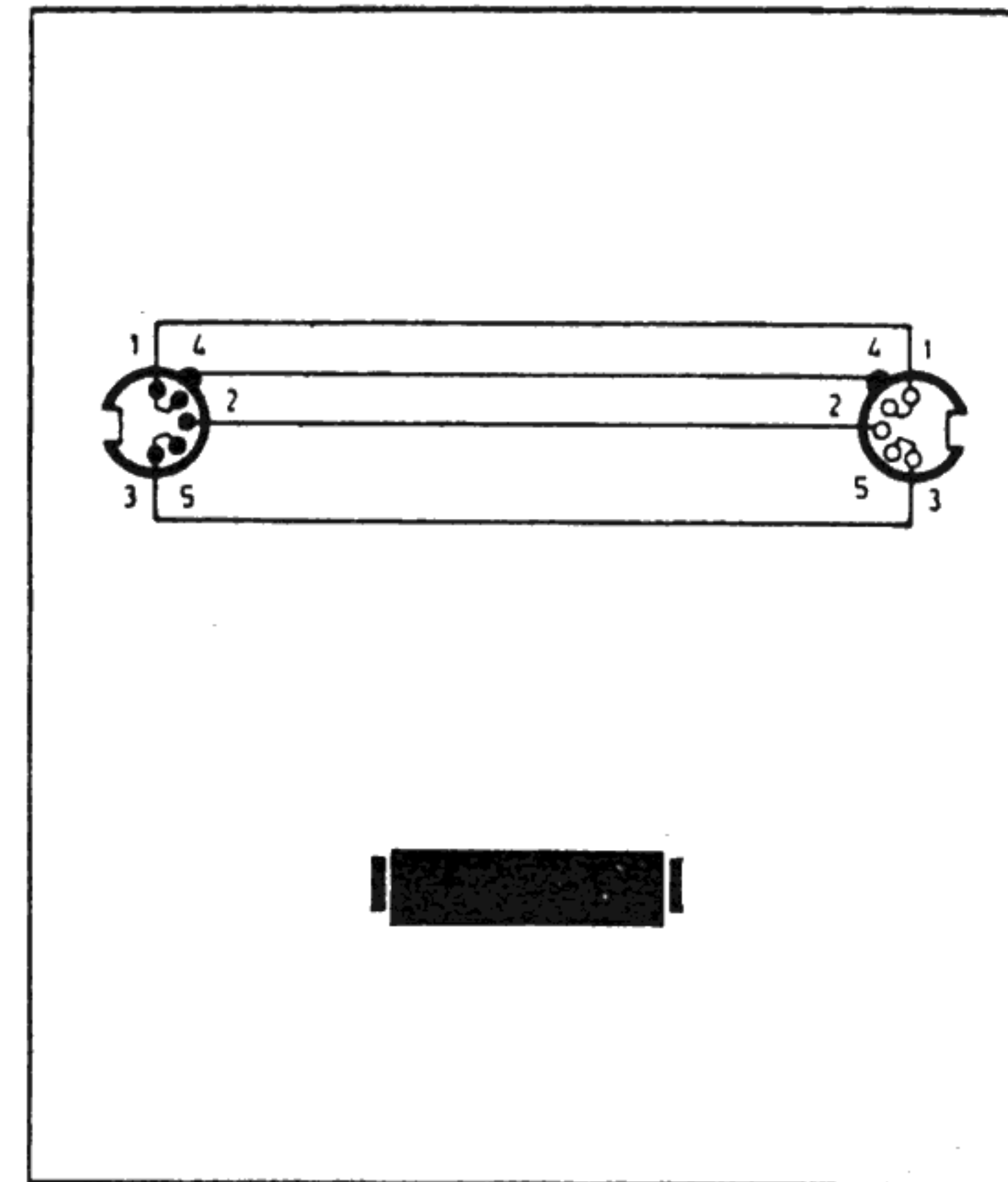

K 837

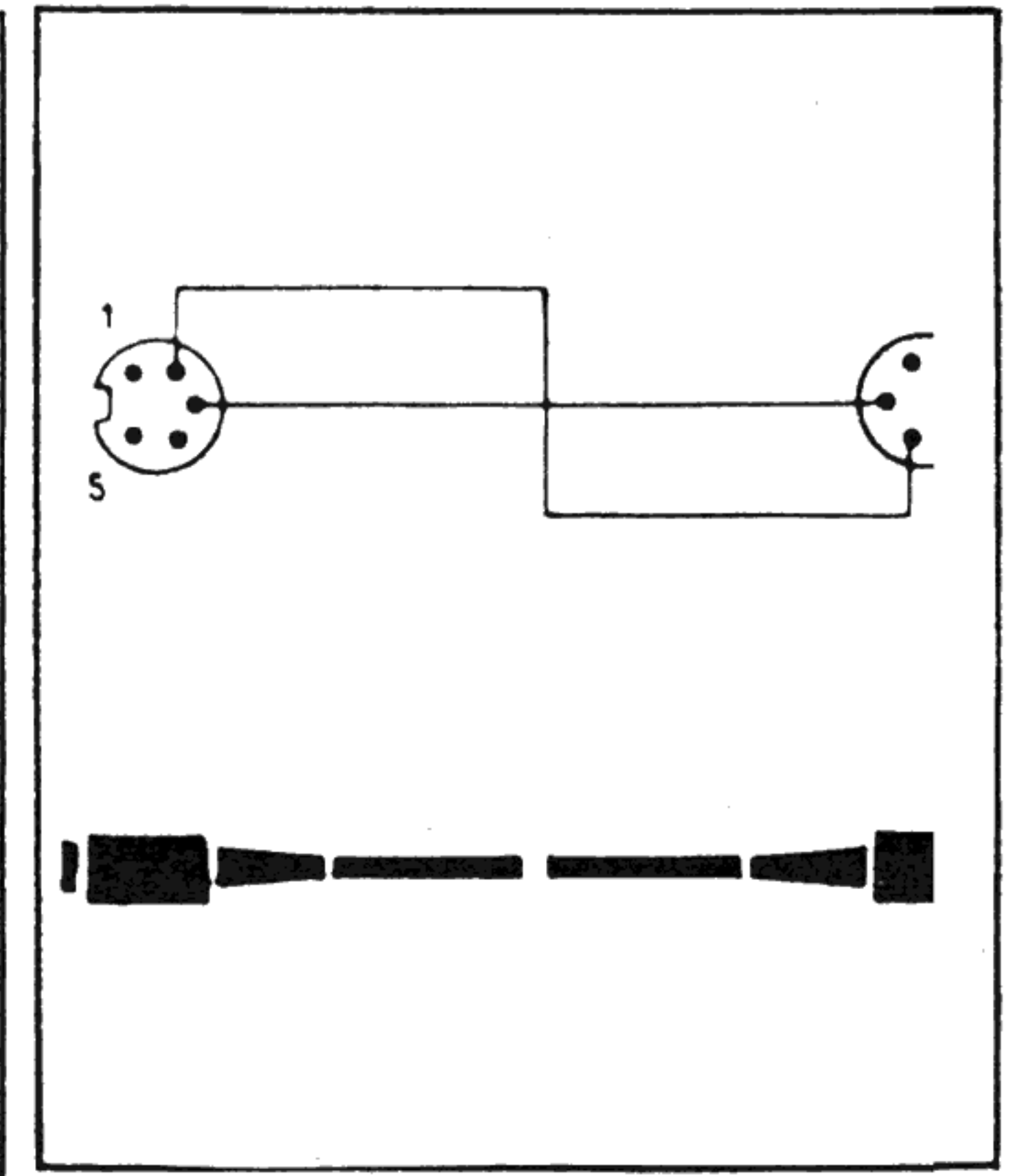

K 911



W 774 (i) W 776 (o)
W 775 (s)



Z 172

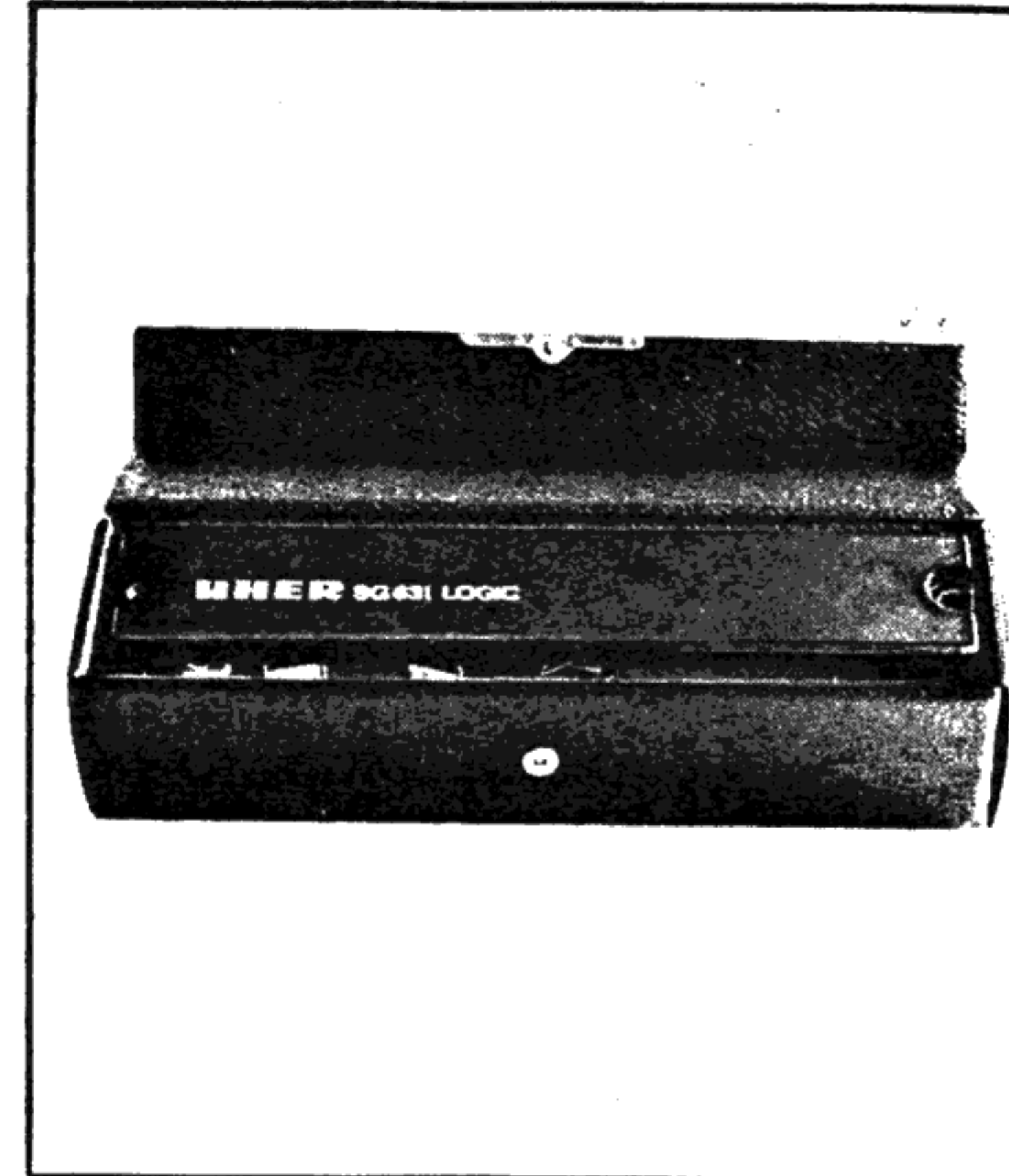

Z 401
Z 411

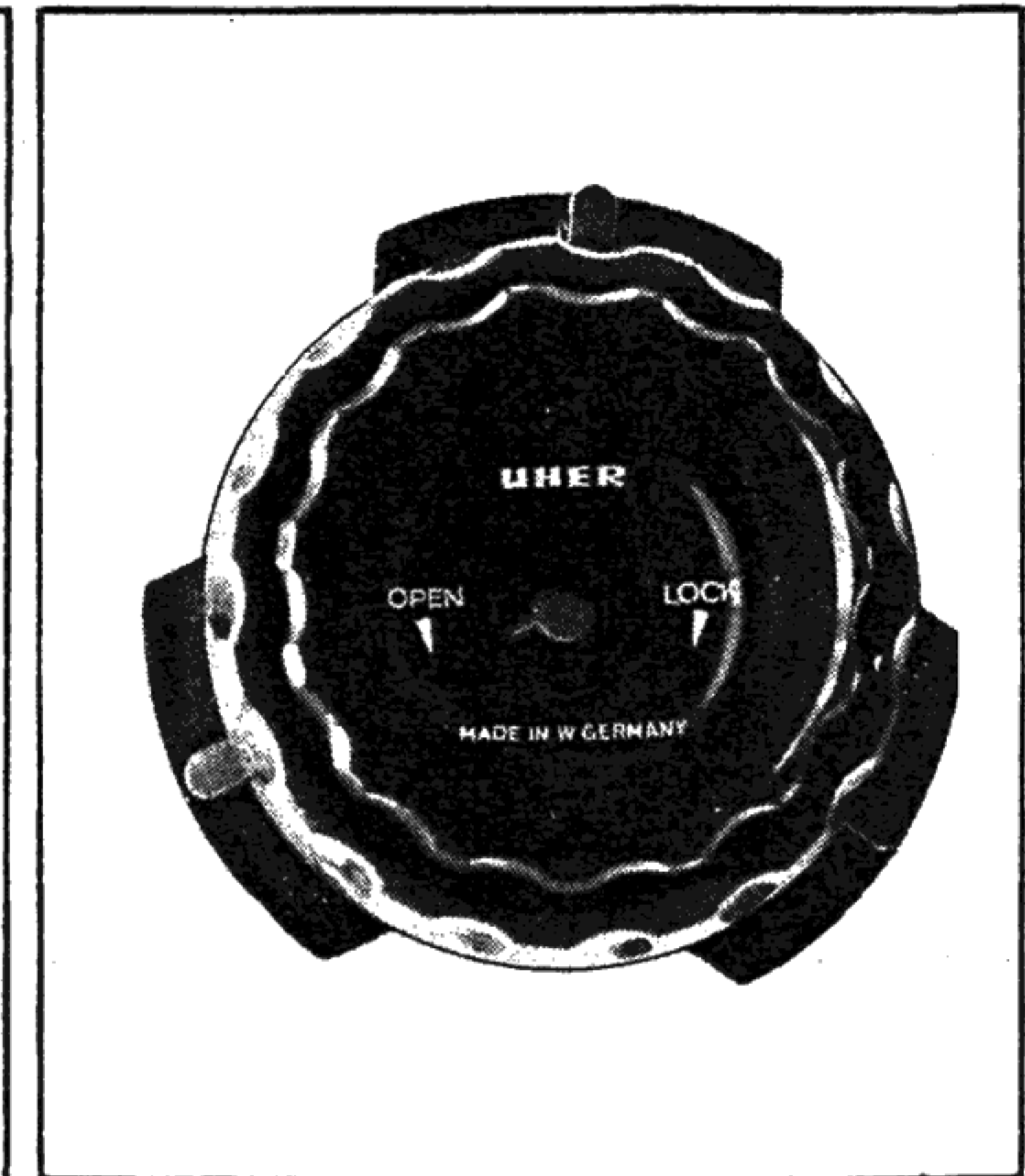

Z 800



UHER

PS 950 stereo

UHER

EG 750 stereo

UHER

VG 850 stereo

UHER

CG 350 stereo
(CG 340 stereo)

UHER

Z 110

UHER

HiFi POOL

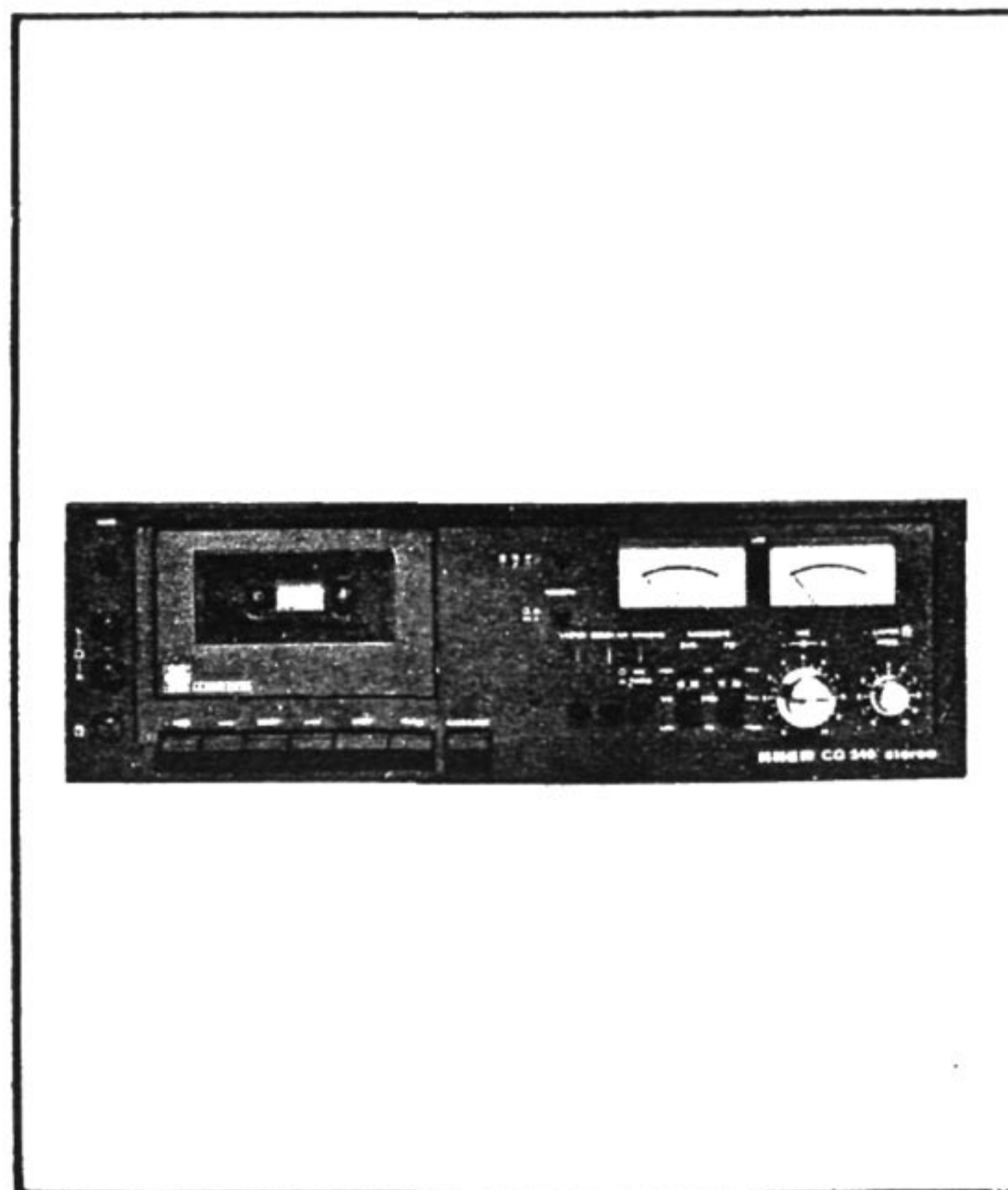

CG 340



4000 IC
4200/4400 IC

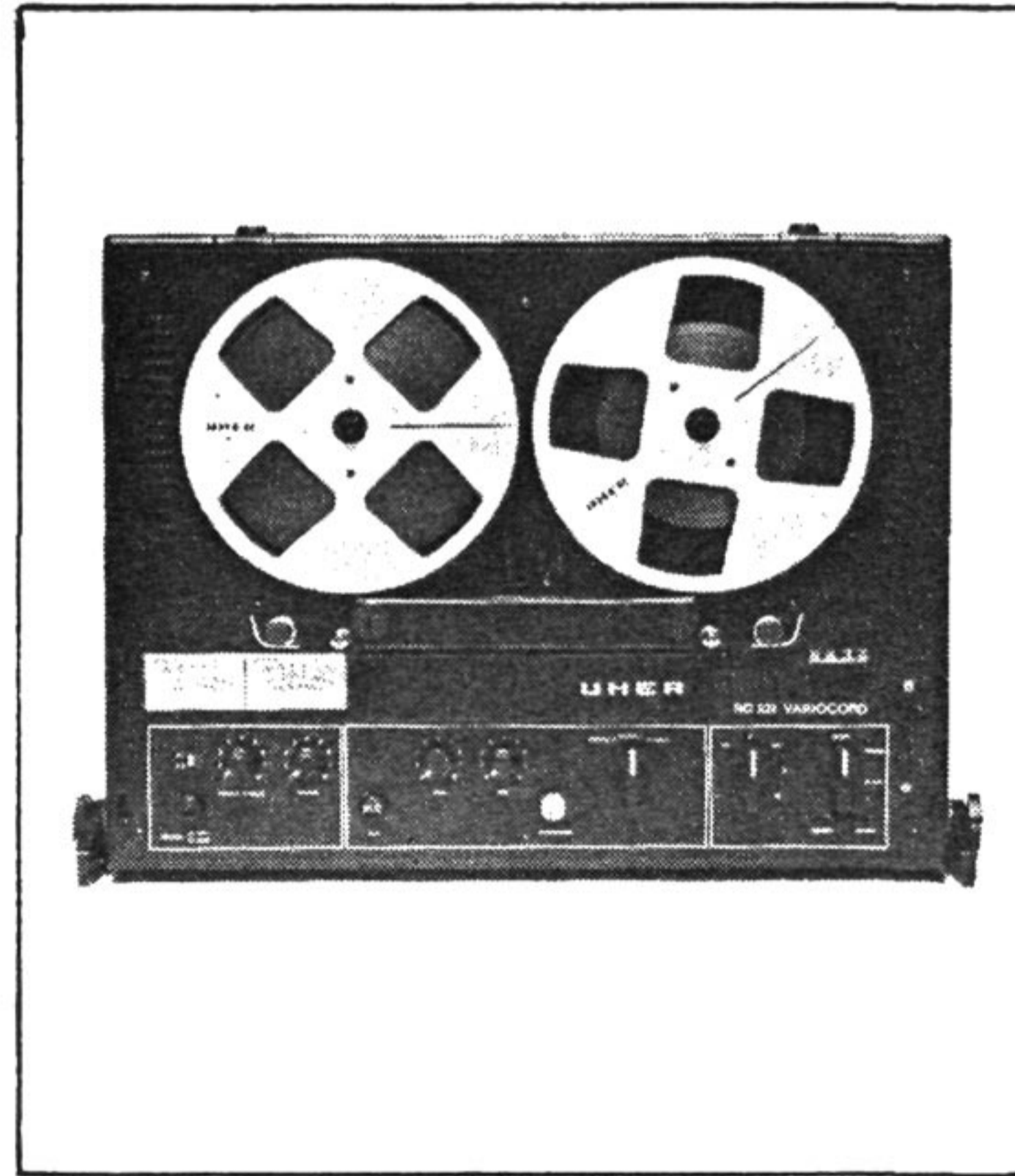

SG 521



SG 561

Bitte umseitiges Schaubild herausklappen

Please fold out this page

Ouvrir le dépliant