

TEAC Tascam Series

80-8

OWNER'S REFERENCE MANUAL



TABLE OF CONTENTS	PAGE
INTRODUCTION	1
CONTROL IDENTIFICATION	2- 4
THEORY OF OPERATION – MAINTENANCE ...	5-18
DAILY SETUP	19
GENERAL ADVICE ON MAINTENANCE	19-20
SERVICE CHART	20-21
CONNECTION AND OPERATION OF THE DX-8 ..	22-23
HOW THE DX-8 WORKS – THEORY	23-24
ENTERING "RECORD"	24-25
SPECIFICATIONS	25

INTRODUCTION

Introduction to the 80-8 and Its Design Philosophy

No matter how elaborate a multichannel tape recorder is, it doesn't do the job without help. A lot of equipment is involved, and a lot of talent as well. The recorder becomes the keystone in a system that involves microphones, mixers, loudspeakers, amplifiers and many sophisticated electronic devices. Everything contributes a part to the system of multichannel recording.

Because of what we have learned about multichannel recording systems in the past 8 years, TEAC decided to concentrate on improving functions in the 80-8 that are strictly the province of the tape recorder and to remove features that we felt were best placed elsewhere in the system. The cost saved by eliminating features that are usually duplicated by our mixers, such as headphone amps and microphone inputs has been used to improve the overall quality of the recorder. The result, a better and more flexible recorder/reproducer for the system of multitrack recording. This logical growth now reflects the needs of the studio style or, if you will, the professional recordist.

It has long been our contention that professionalism is defined by people and what results they achieve. It's not something that automatically happens when you buy a tape machine with a lot of tracks, or a very high price. It's what you do with the equipment and how well you do it that makes the point.

In designing the 80-8, we believe we have been guided by the multi-channel system as it truly is. We are sure our recorder/reproducer can deliver the performance necessary to achieve solid results.

If you would like to comment on our design philosophy, please feel free to contact us. Criticism and comment from our owners has helped us improve our products and our business. We welcome all feedback.

Please send in the warranty card. Although it is not absolutely necessary to insure warranty protection, it will allow us to learn some things about who you are and what you do with tape. From time to time we mail out literature and information of interest to the multichannel recordist. Let us know where you are and we'll keep in touch.

The guarantee of performance that we provide for the 80-8 must have several restrictions. We say that the recorder will perform properly only if it is adjusted properly and the guarantee is that such adjustment will be possible. However, we cannot guarantee your skill in adjustment or your technical comprehension of this manual. Therefore, Basic Daily Setup is not covered by the Warranty. If your attempts at such things as rebias and record EQ trim are unsuccessful, we must make a service charge to correct your mistakes.

Recording is an art as well as a science. A successful recording is often judged primarily on the quality of sound as art, and we obviously cannot guarantee that. A company that makes paint and brushes for artists cannot say that the paintings made with their products will be well received critically. The art is the province of the artist. TEAC/TASCAM can make no guarantee that the 80-8 in itself will assure the quality of the recordings you make.

Your skill as a technician and your abilities as an artist will be significant factors in the results you achieve.

This tape deck has a Serial Number located on the rear panel. Please record the Model Number and Serial Number and retain them for your records.

Model Number _____
Serial Number _____

* dbx noise reduction system made under license from dbx, Incorporated. The word dbx and the Symbol are trademarks of dbx, Incorporated.

WARNING: TO PREVENT FIRE OR SHOCK HAZARD, DO NOT EXPOSE THIS APPLIANCE TO RAIN OR MOISTURE.

CONTROL IDENTIFICATION

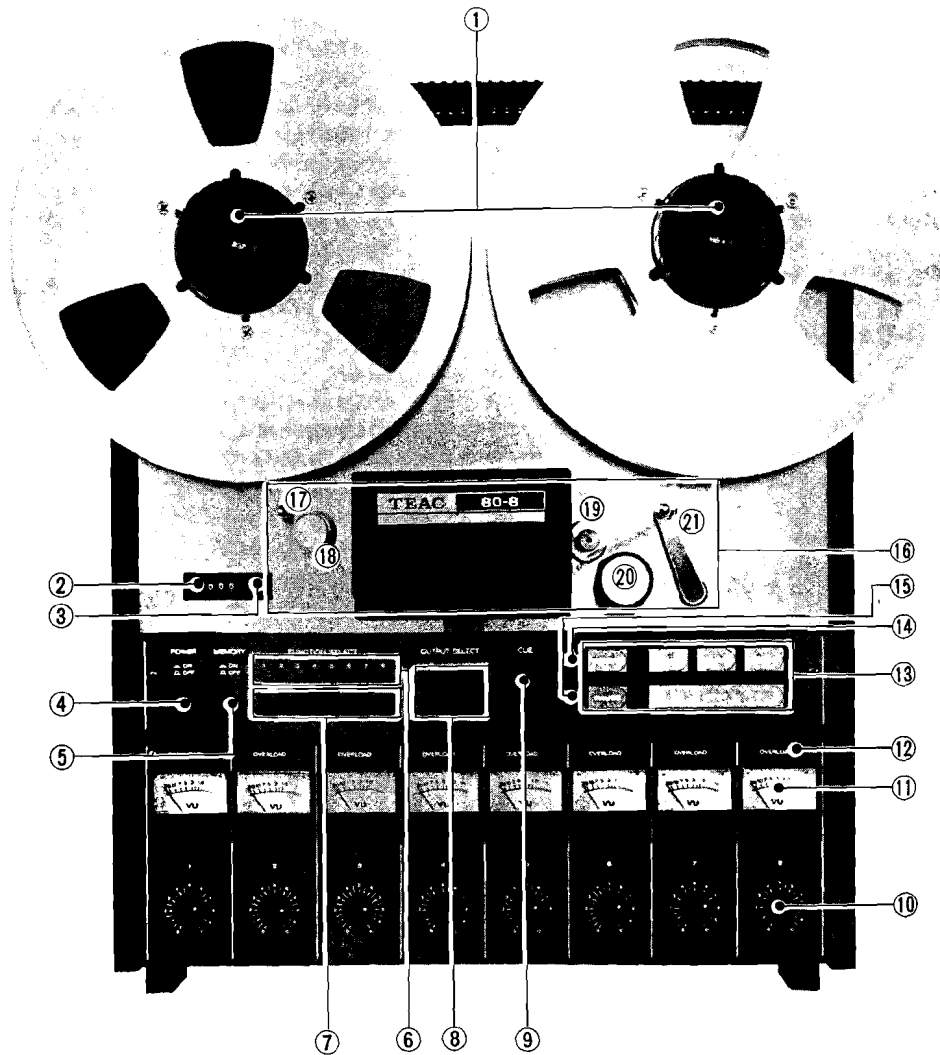

Front Panel Controls and Indicators

① NAB Hub Adapters

Permanently mounted. Use 10-1/2" reel only. Rotate Adapter ring CW to tighten.

② Index Counter

4-digit counter indicates relative location of selections on tape. Used in conjunction with memory button for memory stop operation.

③ Index Counter Reset Button

Push to set counter to zero.

④ POWER Switch

Controls AC power to transport and electronics. Push again to shut off power.

⑤ MEMORY

When depressed, transport will enter stop mode when counter reads 9999 during rewind operation. Actual

stopping point of tape will depend on transport speed when counter triggers the stop operation.

⑥ LED Record Status Indicators (FUNCTION SELECT)

These lights show three states.

Light off – Safe, playback or input

Light blinks – Record ready, but not in progress

Light stays lit – Recording in progress (or RECORD/PAUSE Mode)

⑦ FUNCTION SELECT Buttons (8)

Determine record and play status.

Up – Safe, playback or source determined by OUTPUT SELECT buttons.

Down – Ready to record. If transport controls have selected "Record" depressing button will begin recording immediately. Output of recorder switches to source.

⑧ OUTPUT SELECT Buttons

Selects which of 3 possible sources will feed the output jacks and the meter circuits. LED's above buttons show

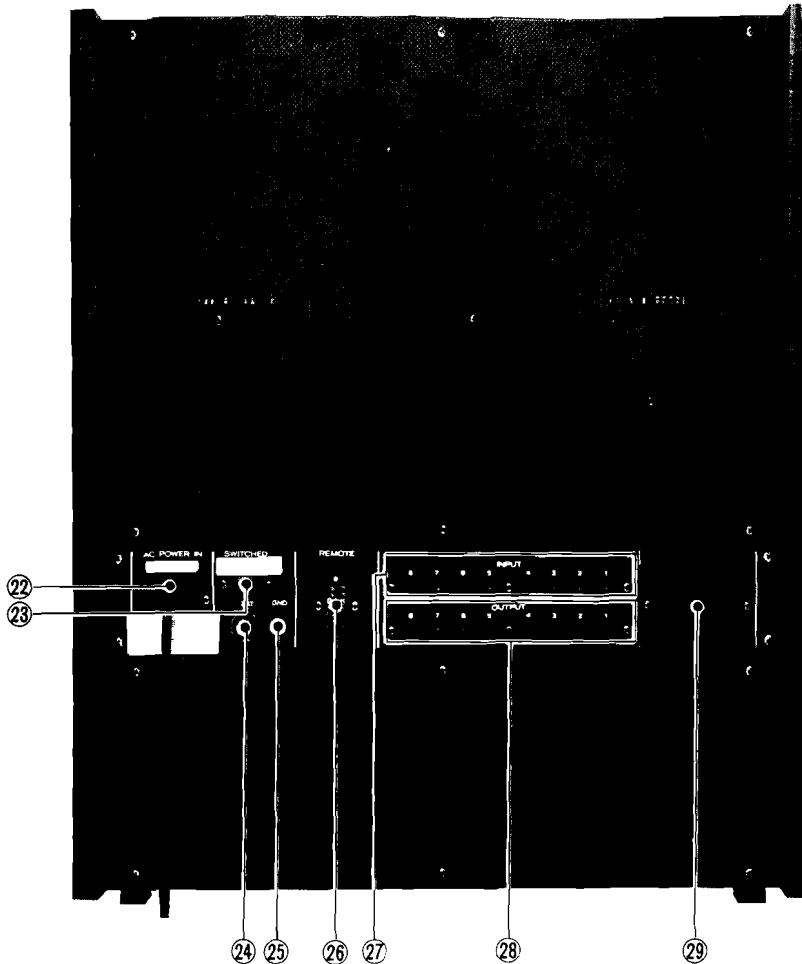

selection.

- INPUT** — Meter reads line input to recorder, input signal appears at output jacks. Tape signal will not be heard.
- NORM** — Used for all normal operations, recording, sync/reproduce and playback. Meter reads input or head #2 play output depending on setting of function select buttons.
- MONITOR** — Selects head #3. Meter now reads tape playback. Does not prevent recording on head #2. Used in set-up to check performance and record/play monitoring of tape.

⑨ CUE Lever

This control will defeat the fast motion tape lifters. The more pressure you apply, the closer the tape will come to the heads. This will allow playback signal to be heard in fast motion for cueing. Use only enough pressure to hear the signal. Too much signal will damage the electronics, so be sure the cue lever is not engaged (locked) when in fast motion. The latch position is provided only for hand winding the tape to find an edit point. Push the lever all

the way up a second time to release.

⑩ Input Level Control (8)

For adjusting the source of line level signal. Setting has no effect on playback.

⑪ VU Type Averaging Meter

For visual reference of input signal levels.

⑫ LED Peak OVERLOAD Indicator

Complements VU meter by monitoring transient peaks. The trigger is factory calibrated at +10 VU, adjustable.

⑬ Transport Motion Controls

6 microswitches — Fast forward, rewind, stop, pause, play and record. The use of a remote control RC-170 will not disable the front panel controls.

⑭ Master Record Status LED

Shows record state.

Off — safe

Blinking — Record ready

On — Recording in progress (or RECORD/PAUSE)

Reel Installation

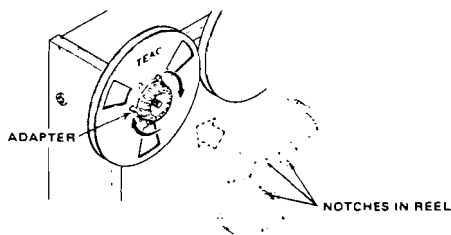

Fig. 1 Reel Installation

Head Location and Adjustment

Head Block illustrations showing all parts, tape path, and all adjustments. Screw for guides and head adjustments. Hex Socket type screws ⑦, ⑧ are for azimuth adjustment.

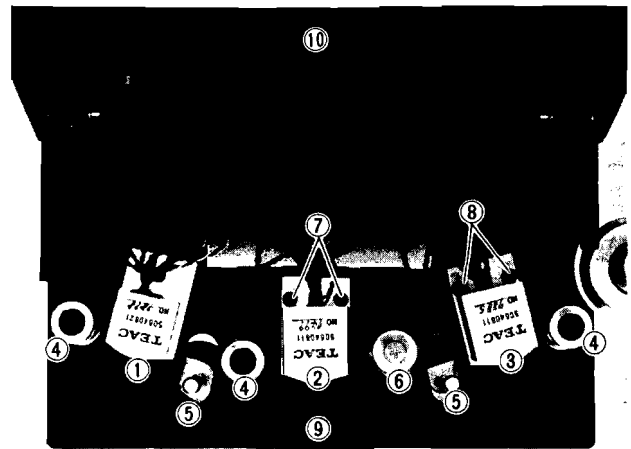

Fig. 2 Head Location and Adjustment

- ① ERASE HEAD
- ② NORM (RECORD/REPRODUCE) HEAD
- ③ MONITOR (REPRODUCE) HEAD
- ④ TAPE GUIDES AND HEIGHT ADJUSTMENT HEX SOCKET SCREWS
- ⑤ TAPE LIFTERS
- ⑥ SCRAPE FLUTTER ROLLER
- ⑦ NORM HEAD AZIMUTH ADJUSTMENT HEX SOCKET SCREWS
- ⑧ MONITOR HEAD AZIMUTH ADJUSTMENT HEX SOCKET SCREWS
- ⑨ NORM HEAD SHIELD COVER
- ⑩ HEAD HOUSING

⑮ PAUSE LED

This LED will blink for the first 10–15 seconds after the power is switched on. Transport will not operate until this LED goes out. Lights up in PAUSE.

⑯ Tape Path

Thread the tape as indicated on the diagram. Over the tape tension arm ⑰ (on reel side) under the impedance roller ⑱ (away from reel) across heads, between capstan ⑲ and pinch roller ⑳ and behind shut off arm ㉑ (away from reel side).

The shut off arm will drop power to the transport if the tape breaks. It's a good idea to allow it to drop when you take a break in the middle of a session. Doing this will stop the constant rotation of the capstan, and will lengthen the life of the capstan motor bearings. It is not necessary to unthread the tape. Just allow it to become slack so that shut off arm can drop.

Back Panel Plugs and Jacks

- ㉒ AC POWER Cord.
- ㉓ AC Switched. AC power supplied when 80-8 is ON. Use no more than 300 W.
- ㉔ FUSE Holder. Contains 3 amp fuse for overload protection.
- ㉕ GND Connection. For connecting a grounding wire between components, or to earth ground as necessary.
- ㉖ REMOTE Control Socket. For optional RC-170 remote control unit. Needs no dummy plug when not in use.
- ㉗ INPUT Jacks. Line inputs for recording are connected to these eight pin cord jacks.
- ㉘ OUTPUT Jacks. Line outputs.
- ㉙ DBX Interface Section. Removal panel for direct integral DBX interface (see DBX Interface section). NOTE: For use with the DX-8 unit *only*.

THEORY OF OPERATION-MAINTENANCE

If you are new to high quality sound recording equipment, you should become aware of the fact that high quality sound requires high quality maintenance.

Recording studios that rent time by the hour are very fussy about maintaining their equipment. Tape recorders and other electronic gear in the studio are checked out before every session. And, if necessary, adjusted to "spec" by an "in house" service technician. He is usually prepared to correct any problem from a minor shift in circuit performance to a major breakdown in a motor. He has a full stock of spare parts and all the best equipment he needs.

Now that you are running your own "studio" you will have to make some decisions about maintaining it, and your 80-8. You will have to become your own "in house" service technician. Well, what about the test gear and the spare parts? A stock of spare parts and a super deluxe electronic test bench can easily cost many times the price of the recorder. Fortunately, the most frequently needed adjustments use the least expensive equipment, and the very costly devices are only needed for major parts replacements such as drive and rewind motors or head assemblies. Replacing parts cannot be considered "daily maintenance" by any means, so we suggest that you leave the major mechanical and electrical repair to the Dealer Service Center. That's what it's for.

Adjustments to the motors — back tension and brake torque are not required often and can safely be left to dealer service. The adjustments for wow and flutter require several thousands of dollars of test gear to perform. It's not practical to consider doing these adjustments yourself unless you have fifty machines to service. Then it might pay to buy the test gear.

In order to help you make plans about the more routine adjustments to your 80-8, we have made this maintenance section of the owners manual as easy to understand as technology will allow. It's a short course in tape recorder theory as well as a list of adjustments and will help you to understand what is going on inside when you record. Read the manual, decide what test equipment you can afford (although it is not violently expensive, it is not free) and determine what service you can do yourself.

Cleaning

The first thing you will need for service is definitely the least expensive — Cleaning fluids and swabs. The whole outfit, 2 fluids and all the cotton swabs you'll need for months cost less than one roll of high quality tape. We can't stress the importance of cleaning too much. Clean up before every session. Clean up after every session. Clean up every time you take a break in the middle of a session (we're serious). How come? Well there are two good reasons we can think of right off the top:

1. Any dirt or oxide buildup on the heads will force the tape away from the gaps that record and playback. This will drastically affect the response. Even so small a layer of dirt as one thousandth of an inch will cause big troubles. All the money you have paid for high performance will be wiped out by a bit of oxide. Wipe it off with head cleaner and get back to normal.
2. Tape and tape oxide act very much the same as fine sandpaper. The combination will grind down the tape path in time. If you don't clean off this abrasive on a regular basis, the wear will be much more rapid and, what's worse, it will become irregular. Even wear on

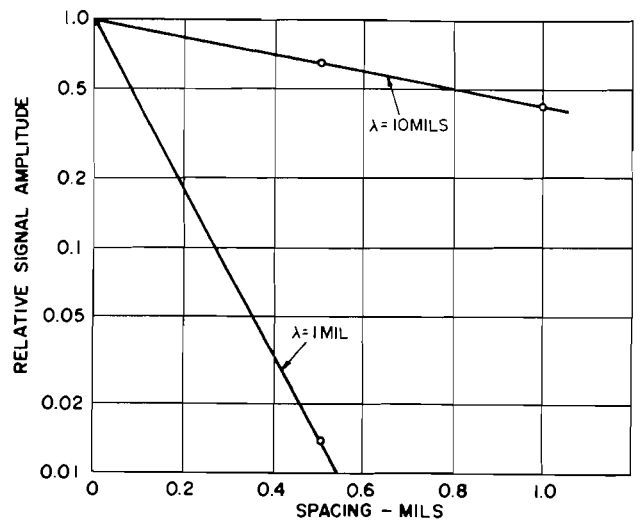

Fig. 3 Curves showing fall-off of reproduced signals versus spacing from reproducer head. (Courtesy, Minnesota Mining and Manufacturing Co.)

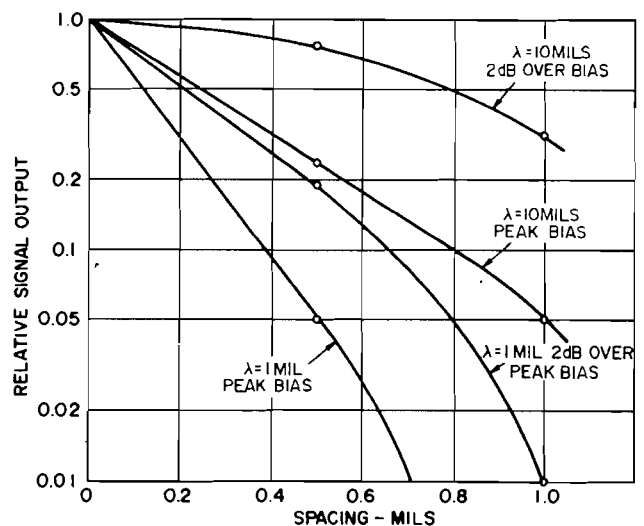

Fig. 4 Curves showing the fall-off of recorded signals versus spacing from recording head. (Courtesy, Minnesota Mining and Manufacturing Co.)

heads can be compensated for by electronic adjustments for a time, but uneven wear can produce notches on heads and guides that will cause the tape to "skew" and skip around from one path to another, making adjustment impossible. This ragged pathway chews up the tape, thus dropping more abrasive, thus causing more uneven wear and so — a vicious spiral that can't be stopped once it gets a good start. The only solution will then be to replace not only the heads, but all the tape guides as well. Being conscientious about cleaning the tape path on the 80-8 will more than double the service life of the head assembly.

Degaussing (Demagnetizing)

A little stray magnetism goes a long way. A long way towards making trouble for your tapes. It only takes a small amount (.2 gauss) to cause trouble on the record head and playing 10 rolls of tape will put about that much charge on the heads and other ferrous parts of the tape path. A little more than that (.7 gauss) will start to erase high frequency signal on previously recorded tapes. Demagnetize the whole tape path, including the tips of the tension arms every six fully played 10½" reels. This is a fair "rule of thumb" even though it may be a bit hard to keep track of. Fast motion isn't as significant to the heads, so we don't give an hourly reference. It's the record/play time that counts.

Degaussing is always done with the recorder turned off. If you try it with the electronics on, the 60 cycle current pulses produced by the degausser will look just like 60 Hz audio to the heads, at about 10,000 VU and will seriously damage the electronics and/or the meters. Turn off the machine, turn on the degausser at least 3 feet away from the recorder. Move slowly in to the tape path. Move the degausser slowly up and down in close proximity to all ferrous parts and, slowly move away to at least 3 feet before turning off.

It's a good idea to concentrate when you are degaussing. Don't try to hold a conversation or think of anything else but the job you are doing. If the degausser is turned off or on by accident while it is near the heads, you may put a permanent charge on them that no amount of careful degaussing will remove — head replacement time again, we're sorry to say. Make sure you are wide awake for this procedure.

A clean and properly demagnetized tape recorder will maintain its performance without any other attention for quite some time. Even if it does drift as a recorder, it won't ruin previously recorded material, and getting it back in good shape will not be too difficult. To make electronic adjustments, you need test gear, so let's go over what's necessary.

1) Alignment Tapes

You need one for each speed that the recorder operates at. For the 80-8 the specs are:

Reference fluxivity: 250 nWb/m

Equalization standard: IEC

15 ips ∞ & 35 μ s

(See page 10; Test Tapes)

These test tapes are made by several companies, but there are many different tape specs. Be sure you have the right one.

Let's talk about each spec separately.

Reference Fluxivity — How much magnetic energy is necessary on the tape to make the meter read "0 VU" in playback? This is the "benchmark" or standard you tune your playback electronics to. 250 nano Webers per meter is the correct value for the 80-8. If a lower or higher "Reference Fluxivity" is used to set up the playback, all your other measurements will be off.

IEC Equalization — Here we have a lot to talk about. The process of magnetic recording is far from "flat." Every circuit in a tape recorder will alter the level of signal with respect to its frequency — some deliberately, some unavoidably. The deliberate errors are used to overcome the unavoidable problems. Here is a selection of frequency response graphs at various points in the recording process:

1. If the input signal starts this way
Beginning, okay

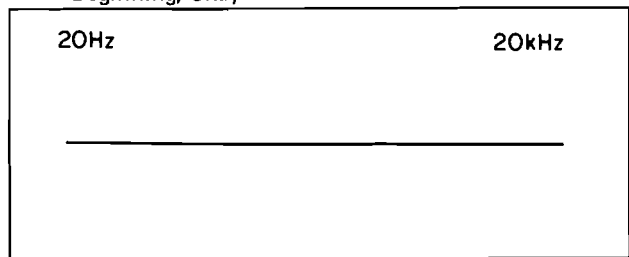

Fig. 5

2. EQ to overcome head loss at high frequency and bass anomalies
Deliberate error

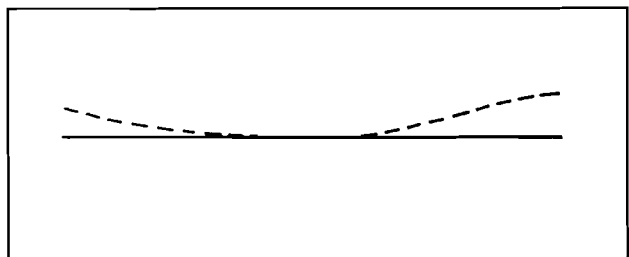

Fig. 6

3. Record Head Response
(6 dB per octave rise until gap in head approaches wavelength)
Unavoidable error
Small wavelengths (high frequencies) are partially erased as fast as they are recorded.

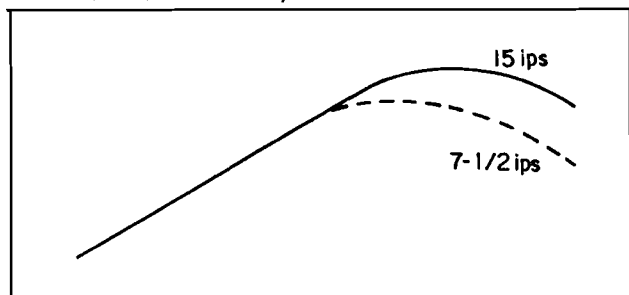

Fig. 7

We will assume something recorded, but it's not flat on the tape either. Now we'll play it back.

4. Playback Head Response
(6 dB per octave rise again, same as record head)
Unavoidable error
Small wavelengths are not picked up by gap.

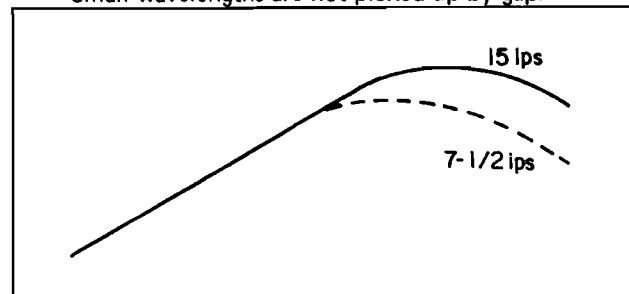

Fig. 8

THEORY OF OPERATION-MAINTENANCE(Continued)

5. Playback EQ

Now we must overcome the characteristic response of heads in magnetic work.
Big deliberate error
Helps lower tape hiss as well as restoring proper levels to high frequencies.

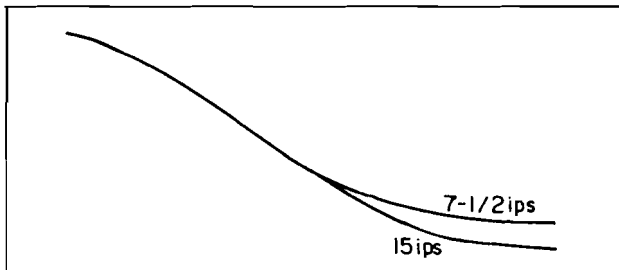

Fig. 9

6. The result of all this equalization is this (hopefully)

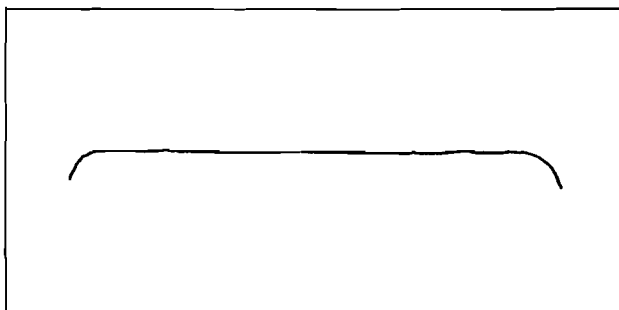

Fig. 10

The idea is to use the electronics that are adjustable to cope with the problems that are caused by the nature of the magnetic recording process. We can't change the basic laws of magnetic physics, so we change the record and playback equalization. Now comes the sticky part. How much EQ do we use in each stage? If every manufacturer of tape recorders used their own standard, their idea of what was best, there would be no playback compatibility. Tapes made on one recorder would not play back properly on another of different make. The standards for record and playback equalization are established by societies of scientists, engineers and users in the profession. They are:

- NAB National Association of Broadcasters
- IEC International Electrotechnical Commission
- CCIR International Radio Consultive Commission
- DIN Deutsche Industrie Normen

Unfortunately, they don't all agree. Each organization has a slightly different approach to solving the problems of tape recording. Scientists and engineers are human, as well, and have been known to disagree, sometimes violently about what ways are best. Advances in the manufacture of tape, improvements in head design, and the lowering of electronic circuit costs have made bizarre solutions quickly change into practical realities. The optimums have shifted and will probably continue to do so. Standards are set by man, not cast in stone.

But while the scientists are boxing in the conference room, we would like to be recording, so TEAC has selected the IEC standard for record/reproduce EQ as the recommendation for the 80-8.

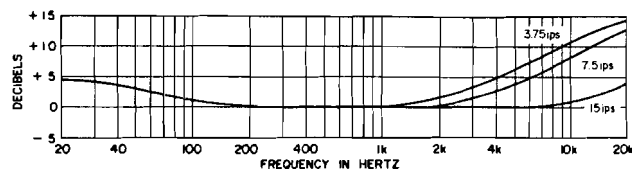

Fig. 11 Typical recording (pre-equalization) for 1/4-inch tape recorders using NAB characteristics.

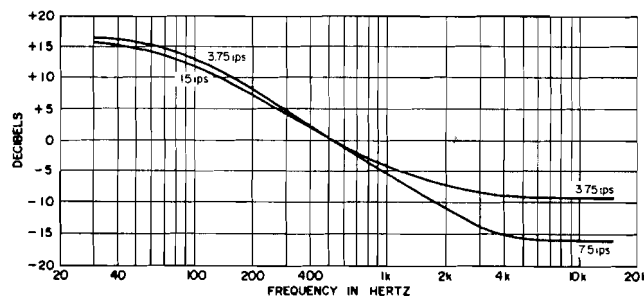

Fig. 12 Typical post-equalization for 1/4-inch tape recorders using NAB characteristics.

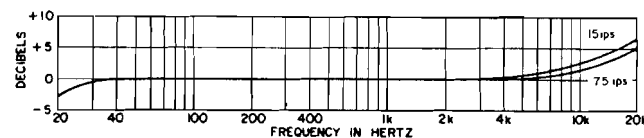

Fig. 13 Typical pre-equalization characteristics for 1/4-inch tape recorders running 7.5 and 15 ips using the CCIR (DIN) standard.

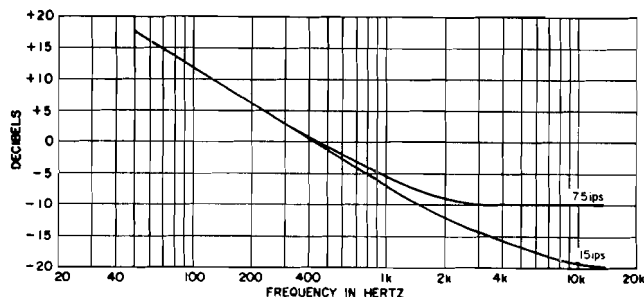

Fig. 14 Typical post-equalization curves for 1/4-inch recorders using CCIR characteristics, at 7.5 and 15 ips.

Since these Reference Standard tapes cost about 3 times the price of a big roll of the best blank tape, plan on storing them carefully in a place that will not encounter any magnetic fields that might damage them — away from loudspeakers, guitar pickup, tape recorder and record player motors, power amplifiers (magnetic field surges in big transformers when amps are turned on and off can be very powerful) or anything magnetic that might alter the quality of the reference standard. If you don't damage them physically or magnetically (don't play them on dirty or magnetized recorders, or loan them out to the careless) they will last for several years.

If it is not possible to obtain a tape that has both the IEC EQ and a fluxivity of 250 nWb/m, select the IEC EQ as the preferred single standard. A different reference fluxivity requires only that you make a level correction once. Just use a different mark on the meter instead of "zero." A different EQ curve requires a different amount of correction for each frequency and is much harder to use — especially for a beginner. Level corrections for different reference fluxivity:

		Use this
		instead of
		"0" VU
15 ips	185 nWb/m — (Ampex operating level)	-3 VU
	200 nWb/m — (STL, MRL)	-2 VU

Below are tabulated some commonly encountered flux levels along with their dB differences, and their differences in dB from 185 nwb/m.

	Flux Level nwb/m	Flux Level Difference in dB	Difference from 185 nwb/m in dB
	150	0.56	1.82
	160	0.53	1.26
	170	0.50	0.73
	180	0.24	0.24
Ampex operating level	185	0.23	0.00
	190	0.45	0.23
	200	0.42	0.68
	210	0.40	1.10
	220	0.39	1.51
	230	0.37	1.89
	240	0.35	2.26
	250	0.34	2.62
3 dB above Ampex operating level	260	0.04	2.96
	261.32	0.28	3.00
	270	0.32	3.28
	280	0.30	3.60
	290	0.29	3.90
	300	0.28	4.20
	310	0.28	4.48
DIN Standard	320	0.27	4.76
	330	0.26	5.03
	340	0.25	5.29
	350	0.24	5.54
	360	0.24	5.78
6 dB above Ampex operating level	369.12	0.22	6.00
	370	0.02	6.02
	380	0.23	6.25
	390	0.23	6.48
	400	0.22	6.70

IEC Correction Chart (illus.)

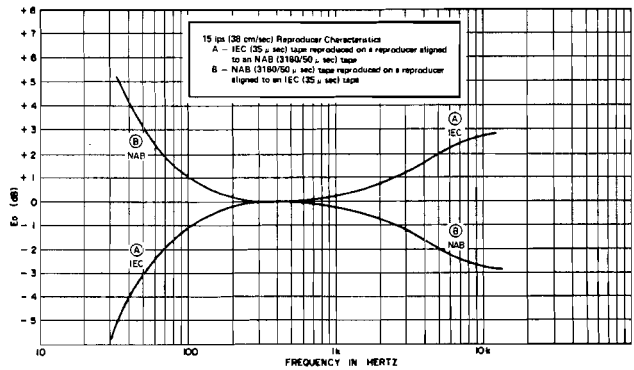

Fig. 15

If you must use NAB EQ tapes, these amounts of reading are correct. NAB has more boost in playback, the tape will read progressively higher as frequencies rise when played on an IEC adjusted recorder. At 250 nWb/m reference read these numbers to set IEC EQ.

30	50	100	400	1K	3K	5K	7K	10K	15K	Hz
0	0	0	0	-0.2	-1.2	-1.9	-2.3	-2.6	-2.9	dB

Since the low frequency EQ on the 80-8 is fixed, the differences are academic. On to the next piece of test equipment.

2) VTVM or FET Multimeter

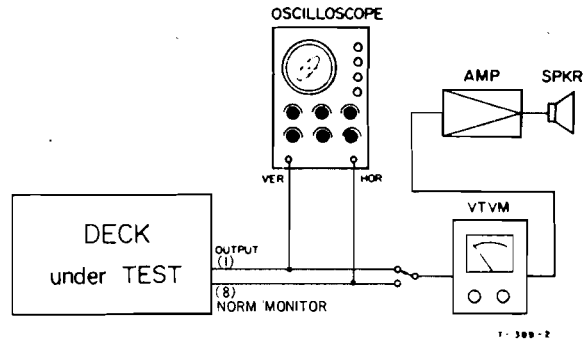

Fig. 16 Head Alignment Fine Adjustment Set-up and Test Connections (PLAYBACK)

With an input impedance of at least 1 megohm that can read levels down to -80 (full scale) you can think of this as a very accurate VU meter of very wide range. Meters with lower input impedances will draw power from the circuits to be measured and will affect the readings. Meters that have adequate input impedance but do not read below -40 (.01 V) can be used for reference levels and frequency response measurements, but will not be capable of making signal-to-noise, erase efficiency or bias circuit measurements where the output of the circuit being adjusted is expected to be very low.

THEORY OF OPERATION-MAINTENANCE(Continued)

This tool is not cheap and is just as important as the test tapes. Without a good reference meter, you can do very little in the way of accurate adjustment. Spend as much as you can here. It's worth it. Next. . .

3) Signal Generator or Oscillator.

Here you get a break. A simple oscillator will do all the work and won't send you to the poor house. There are several on the market for less than \$100. If you get one with a meter on it, you won't have to calibrate its output with the big meter as often. This device is very useful in a studio for troubleshooting a good investment. It should have at least the following frequencies.

40 Hz — 400 Hz — 1 kHz — 4 kHz — 10 kHz — 15 kHz

Sine wave is all that is required, at a distortion of no more than .5%. Most modern units do better than this easily. This unit is the workhorse on the equipment list. Whether you are reading the big meter (FET) or the meters on the recorder, you will need a signal to read, this instrument or the test tapes will provide you with signals.

Test tapes, tone generator, VTVM or FET meter . . . This is the basic package and will do almost every adjustment in the sequence — except the first one . . .

4) The Oscilloscope.

Even a simple one is not cheap. Fortunately, a simple one is all you need. You can spend \$6,000 and more for the big ones, but for this purpose \$100 — \$200 will be more than enough. It must have a "vertical" and a "horizontal" amplifier and an X-Y mode. That's all you use to do the one adjustment you need it for. Tilt, height and tangency adjustments on the 80-8 are virtually unnecessary. The precision head block mounting plate practically guarantees long term accuracy in these areas. Only major physical force will disturb the relationship of the head block to the tape path. As long as you don't drop the recorder "face down" or strike the head assembly with a hammer all should be well. A small azimuth adjustment (± 0.5 degrees) is provided for fine tuning. This adjustment is accomplished by applying screw thread pressure to a slot in the base of the head itself. (See Fig. 21, pg 10.)

Assuming that the motors are not in need of attention (that's for Dealer Service), Azimuth, or head alignment is the number one step in maintenance. . . so let's begin.

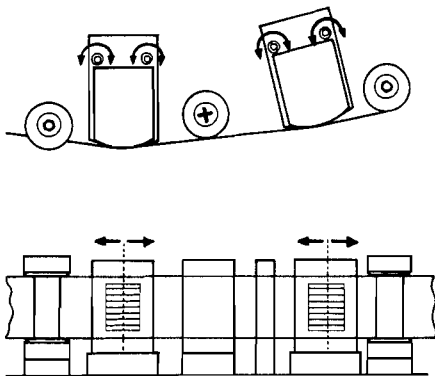

Fig. 17 Head Adjustment (Azimuth)

The gaps in the heads that do the erasing, recording, and playing back must be precisely perpendicular to the tape. PRECISELY. Even a tiny error in alignment will make problems for the recorder. If the heads are not in alignment, both with the tape, and with respect to each other, tones recorded on one head will not play properly on the other. In the table below, the error is shown with the loss in dB for 1K and 10K. The amount of tilt is given in the fractions of a single degree called minutes, 60 minutes to a degree. As you can see, it only takes $\frac{1}{4}$ degree to cause big trouble.

1-Mil Wavelength		$\frac{1}{2}$ -Mil Wavelength		$\frac{1}{4}$ -Mil Wavelength	
Loss in dB	Azimuth Error in Minutes	Loss in dB	Azimuth Error in Minutes	Loss in dB	Azimuth Error in Minutes
0.5 dB	14.86	0.5 dB	7.43	0.5 dB	3.71
1.0 dB	20.90	1.0 dB	10.45	1.0 dB	5.22
2.0 dB	29.21	2.0 dB	14.60	2.0 dB	7.30
3.0 dB		3.0 dB	17.67	3.0 dB	8.83
4.0 dB		4.0 dB	20.16	4.0 dB	10.08
5.0 dB		5.0 dB	22.16	5.0 dB	11.13
6.0 dB		6.0 dB	24.08	6.0 dB	12.04
7.0 dB		7.0 dB	25.68	7.0 dB	12.84
8.0 dB		8.0 dB	27.09	8.0 dB	13.54
9.0 dB		9.0 dB	28.36	9.0 dB	14.18
10.0 dB		10.0 dB	29.50	10.0 dB	14.75

Fig. 18 Loss due to azimuth misalignment for 43-mil quarter-track. (Courtesy, Ampex Corp. Test Tape Laboratory)

Since the 80-8 can use a single head (head #2 in the stack) to perform all functions (recording, sync play and playback) it won't hurt the recorder to use the "whizbang studio alignment" procedure, which is to do nothing about alignment at all. You won't notice anything wrong with the sound you make, but there are drawbacks.

1. Your tapes won't play properly on any other recorder (whizbang standards are unique).
2. No accurate tune-up of the recorder will be possible, as most test procedures use one head as a reference for the other. To do this, they must be aligned perfectly.

Thread the 15 ips test tape on the recorder and find the operating level section of the tape. Connect the outputs for tracks 2 and 7 of the recorder to the 2 inputs of an oscilloscope, track 2 to the vertical input that makes the beam draw lines up and down and 7 to the horizontal input (draws lines left to right). Set the 'scope to the "Vector" or XY mode. You will have to consult the instrumentation book for the scope to determine how to do this. We don't know what brand of test gear you have. Play the tone, and this is what you should see:

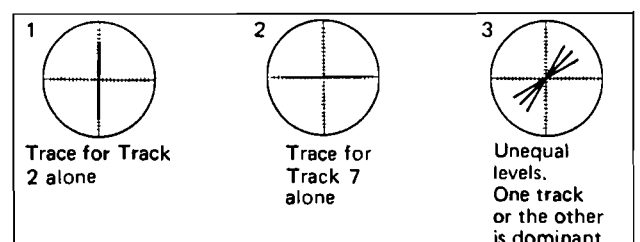

If the lines are not the same length for each track alone, it indicates that the 2 tracks are not putting out the same level. Adjust with the 'scope controls. If the playback head is not straight up and down, you will see this kind of picture:

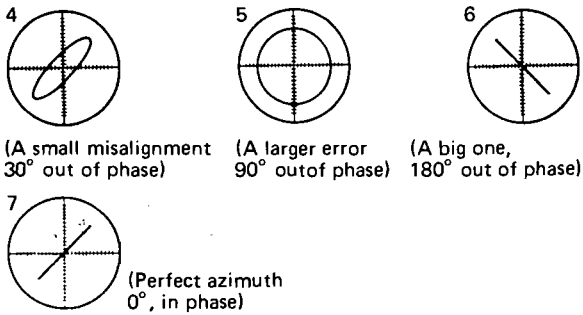

Fig. 19 Phase Shift

How much distance error is involved depends on the frequency or pitch of the tone and the speed of the tape. One "cycle" per second at 15 ips would be hard to misalign. To get Scope picture No. 6, you would have to separate the gaps in the playback head by 7½ inches, but one cycle per second is not audio. How about 1,000 cycles per second of tape travel? At 15 ips, the separation or tilt in the head for scope picture No. 6 becomes .0075 inch. And at 15,000 Hz at 15 ips it's .0005 inch. Not much tilt will produce a big error. Slower tape speeds mean even smaller spacings and good azimuth becomes even more important. The proper method of adjustment is to look first at a long wave, say 1000 cycles, and make a coarse adjustment. Then work up in frequency, adjusting shorter and shorter wavelengths smaller and smaller amounts. If you start adjusting with 10kHz or 15kHz, you can make a big mistake. Here's why. . . . Since the very short wavelengths are very close together on the tape, it is possible to get a good "picture" on the scope by adjusting one full cycle off. If you work up to 15K, checking and adjusting as you go, you will avoid this mistake.

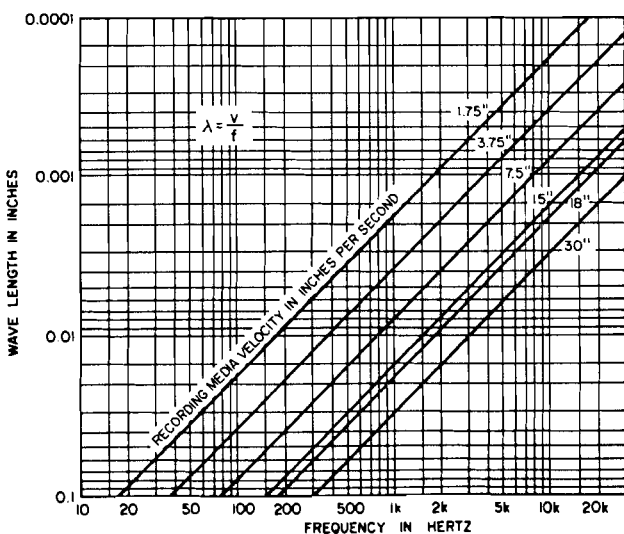

Fig. 20 Velocity of recording media versus recorded wavelength in inches for a given frequency.

Once you have everything set up — the reference tape is playing, the scope is running and showing the x-y display, you need a Hex Wrench and this diagram to find the right adjustment point. Adjusting the screw will rotate the head very slightly.

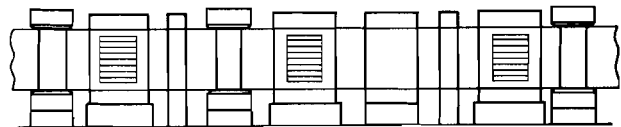
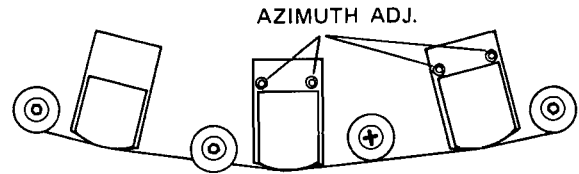

Fig. 21 Head Adjustment Screws and Alignment

Test Tapes for 80-8

TEAC YTT-1104SP (for reproduce alignment)

Tape speed: 15 ips; reference fluxivity: 250 nWb/m; equalization: IEC; time constant: ∞ & 35 μsec.

— or —

MRL31J-129 (Magnetic Reference Lab.)

All specs are identical with YTT-1104SP except for the reference fluxivity which is 200 nWb/m and thus its reproduce output level will be 2 dB lower.

The next step is to play all the signals from the lowest frequency to the highest on the 15 ips alignment tape — one play for each head position (2–3), and DO NOTHING. Just have a look.

It's not a good idea to turn knobs just to "see what happens." Just because an adjustment can be made doesn't mean it's necessary. The recorder is very solid and is well adjusted at the factory, so in all test and maintenance procedures, check first, then if something is not right, adjust. Taking your time will save endless grief. A new machine is very likely to be "on the money" when you get it and if you keep it clean and degaussed will drift away from top shape very slowly. It's not necessary to plan on a major overhaul when it comes out of the box.

THEORY OF OPERATION-MAINTENANCE(Continued)

Locations of Electrical Adjustments

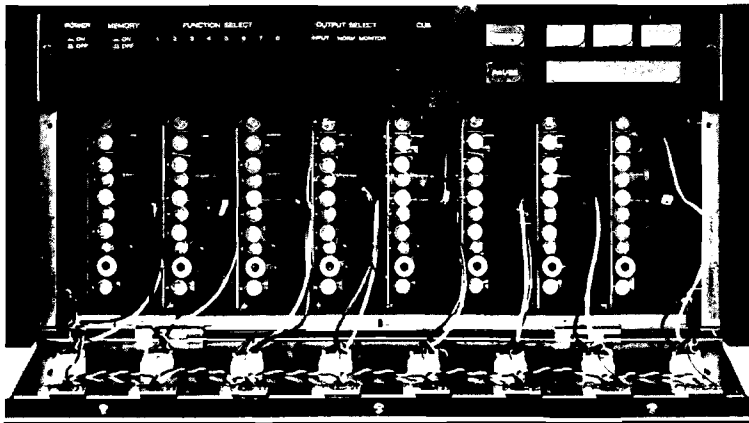

The electronics for the record, reproduce, and bias amplifiers are on one PC card per channel.

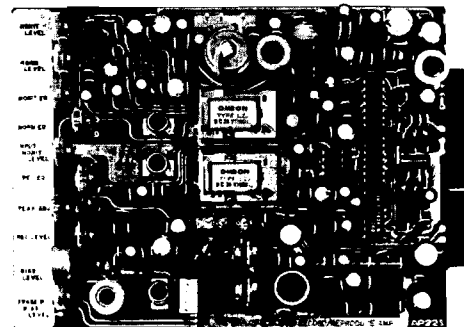

TRIM POT NUMBER	REFERENCE NUMBER	FUNCTION
# 1	R104 10kOhms	MONIT LEVEL
2	R103 10k	NORM LEVEL
3	R105 22k	METER CAL
4	R102 6.8k	MONIT EQ
5	R101 6.8k	NORM EQ
6	R107 22k	INPUT MONIT LEVEL
7	R111 1k	ERASE & BIAS LEVEL
8	R112 50k	BIAS LEVEL
9	R110 10k	REC LEVEL
10	R108 3.3k	REC EQ
11	R109 470	PEAK ADJ
12	R106 22k	PEAK LED
-	L ₁	REPRO BIAS TRAP
-	L ₂	REPRO BIAS TRAP
-	L ₃	RECORD BIAS TRAP
-	T ₂	INTER STAGE TRANSFORMER

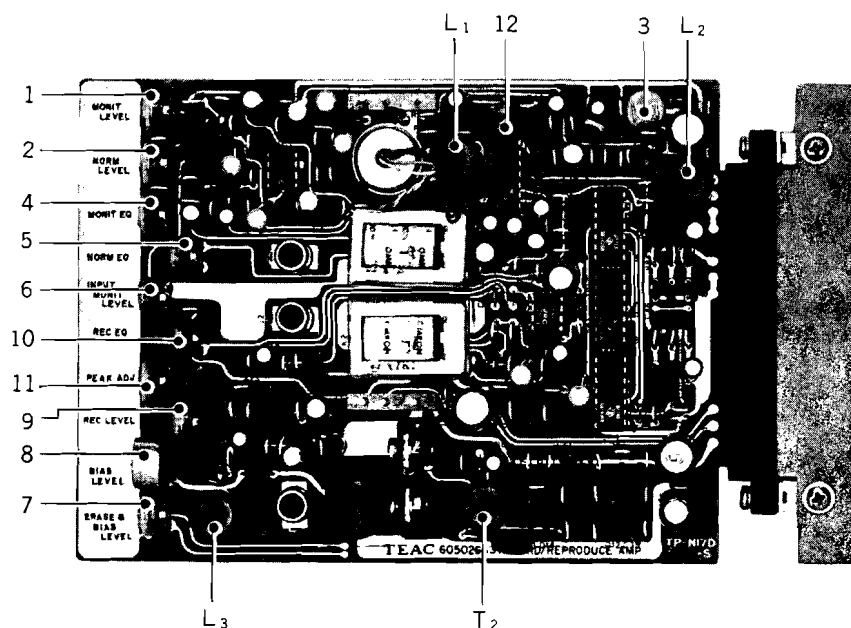

Note: Value of "dB" in the Data refers to 0dB = 1V, except where specified. If a Test Set or VTVM calibrated to 0 dB = 0.775V is to be used, appropriate compensation should be made.

For example, -10 dB (0.3V) is applied to the line in jacks, the VTVM which is connected at the line output jacks reads -7.8 dB (0.3V) instead of -10 dB (0.3V).

Electrical Adjustment Procedure

REPRODUCE CALIBRATION:

When we're sure the playback and record heads are properly aligned, we can move on to the electronic adjustments.

The first step here is to actually check your meter calibration. To open the service door loosen the 2 captive screws, one in each upper corner. The panel hinge requires a clearance of about 3/8" before it can tilt forward, so a sliding mount on the bottom edge of the service door has been provided. Draw the entire panel straight out slightly before attempting to tilt the top edge forward.

Connect the VTVM to the output terminal of track 1. Turn the machine ON, and thread the 15 ips alignment tape. Play the "operating level" portion (a voice on the tape identifies each section at the beginning).

Switch the OUTPUT SELECT on the 80-8 to MONITOR. Adjust the playback or "reproduce" level with trim pot #1 R104, 10k Ohms MONIT LEVEL, until the VTVM reads -10 dB (0.3 V).

Switch the OUTPUT SELECT to NORMAL. Adjust the playback level with trim pot #2 R103, 10K Ohms NORM LEVEL, until the meter reads -10 dB (0.3 V).

Now read the meter on the front panel of the 80-8. It should read "0 VU."

If it does not, then you must use the extender card to gain access to the proper control pot. Carefully remove channel 1 electronics from the machine. But don't unplug the cables that are attached to it. There

is just enough wire on them to allow you to attach the card extender (see ill.) to the electronic card, and replace the whole works in their proper receptacle. The card will now operate, but will sit up so you can see all the components on the board. Find trim pot R105, 22k Ohms. This pot is mounted on the top of the card on the component side of the board.

Adjusting R105 will allow you to set the meter on the 80-8. You adjust the 80-8 meter to read "0 VU," not -10, the reading on the VTVM. The VU meter will read 0 at any voltage you set it for - the correct one is 0 VU. This is the right setting for the 80-8. You read -10 dB (0.3 V) on the VTVM and adjust the 80-8 meters to read 0 VU at this level.

Thus, the card extender is necessary only if the 80-8 meters do not read 0 when the VTVM reads -10 dB. Remove the test tape from the 80-8, turn off the power, and disconnect the card extender. Return the channel 1 electronics to its proper place in the rack. Rethread the tape, and turn the power on. Plug the VTVM into channel 2 output. Play the "operating level" section of the test tape. Switch the OUTPUT SELECT to MONITOR, adjust trim pot #1 on track 2 electronics so the VTVM reads -10 dB (0.3 V).

Switch the OUTPUT SELECT to NORMAL, adjust trim pot #2 on track 2 electronics so the VTVM reads -10 dB (0.3 V). Now read track 2 meter. It should read 0 VU. If not, you must repeat the previous procedure for adjusting the meter circuit (card extender, etc.)

THEORY OF OPERATION-MAINTENANCE(Continued)

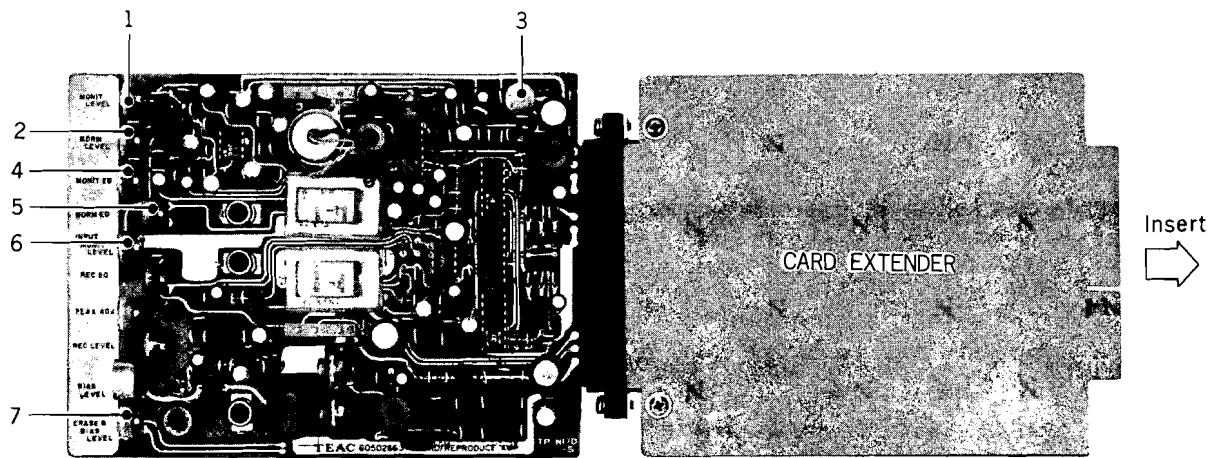

Electrical Adjustment Procedure

Six tracks still remain to be checked and adjusted, but as you can see, the adjustments are the same as for track 1. In brief:

1. play the tape "operating level"
2. read the VTVM for head 3, MONITOR
3. adjust for -10 dB (0.3 V) reading with trim pot #1
4. switch to NORMAL on OUTPUT SELECT
5. read the VTVM. Adjust trim pot #2
6. read the meter on the 80-8 – it must read 0 VU
7. adjust the meter trim pot #3 R105, 22 k Ohms METER CAL

You do this for all 8 tracks: 16 level sets and, if necessary, 8 meter trims. Don't get discouraged. When you are unfamiliar with anything, it takes more time. Practice will speed things up. The entire adjustment procedure involves reading and setting (if necessary) about 128 controls. When you are used to doing it, it should only take about an hour and a half. Have patience, you'll learn soon enough. It is absolutely worth it.

One more word of encouragement. The circuits in the 80-8 are very stable. Most of the time you will make a reading and not have to adjust anything. When something does go wrong, you will be able to fix it very quickly, and get back to recording.

In summary, with the VTVM and test tape, you have adjusted the playback level on the 80-8 to the test tape. But your playback reference is not yet complete. You have only "zeroed" one point on a line of frequency response. To establish the rest of the line,

you must measure and adjust one more frequency. Advance the alignment tape for 15 ips to the section that is recorded at 16 kHz and adjust the trim pot marked MONIT EQ #4 R102, 6.8 k Ohms – switch to NORMAL on the OUTPUT SELECT, and adjust trim pot #5, R101, 6.8 k Ohms NORM EQ. The reading for both positions should be -10 VU on the 80-8 meters. Since you have checked and adjusted the playback meter circuit, you now can use the meters on the 80-8 for the test readings.

By adjusting all of the preceding trimmers, you have established two things: an operating playback level or "zero", and a playback frequency response reference. You know that both heads on the 80-8 are reproducing the test tape in an identical manner.

RECORD CALIBRATION:

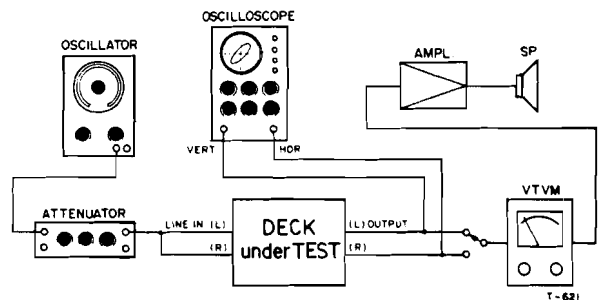

Fig. 22 Test Connection for Recording Check

Now you can use the MONITOR head as a test instrument to check and adjust the record circuits. Almost all of the following steps involve recording a tone on a tape and reading the playback output of the recorder. **YOU WON'T ALTER THE PLAYBACK CONTROLS.** They are now all set. You will make all necessary adjustments by trimming the record electronics.

This way, you can be sure that the recordings you make, no matter what brand of tape you use (the brand of tape becomes part of the test procedure when you record your test tones on it), will playback properly on any 80-8.

The alignment tape can be put away. Before storing, the tape should be played all the way from front to back (not fast wound), and stored tails out, so it will last longer. Even if you decide not to attempt any major maintenance yourself, we strongly suggest you purchase an alignment tape. An occasional playing will tell you when you need to call the "doctor". It's good insurance to know the truth.

The record adjustments begin with the INPUT MONIT LEVEL trim of the 80-8. The INPUT MONIT LEVEL controls the meter reading of the signal as it arrives at the electronics (before it is recorded). You must be sure you are sending the right amount of signal in before you can adjust record levels and equalization controls.

Connect the reference level, or signal generator to track 1 input on the 80-8. The correct level is -10 dB (0.3 V).

The frequency to use is 1 kHz. Rotate the front panel knob to the "2 o'clock" position. It's a good idea to mark it. Check the OUTPUT SELECT. Make sure you have the button marked INPUT depressed. If you get a reading, use trim pot #6 R107, 22 kOhms, INPUT MONIT LEVEL, and adjust the meter to read 0 VU. As always, repeat this check on all 8 tracks of the 80-8. Plugging and unplugging test equipment can be tedious. You can save some time by doing a reference check on your mixer. If you know that your console meter reads 0 VU accurately (check it with the VTVM), you can assign the reference oscillator signals to the 80-8 through the mixer connections to the inputs. Assign, read, adjust: next track, assign, read adjust. . . no need to pull plugs.

ABOUT THE BIAS:

At this point in the adjustment procedure we'll stop for a time and talk about a major section of the recorder electronics. The Bias Oscillator and its related circuitry. The Bias Oscillator produces a very high frequency signal that does two big jobs in the 80-8. It supplies the 100 kHz (one hundred thousand cycles per second) frequency to the Bias Amplifiers in the 80-8. There is a Bias Amplifier on every card, one for each track. The Bias Amplifier provides power for the erase head and bias signal for the record head. Erasure is easy to explain, so we'll tackle that subject first. A lot of power is used to remove all signal from the tape just prior to its being recorded. The erase head has a rather

large gap and completely cleans off any magnetic field on the tape by brute force. No new signal is recorded by this head. The gap is much too large to be effective as a recording device.

From the same amplifier, current is added to the record head circuit lead. This high frequency signal overcomes magnetic inertia in tape, and gets everything moving. If there were no "starter current" to help the record signal, we would see this kind of trouble on a scope.

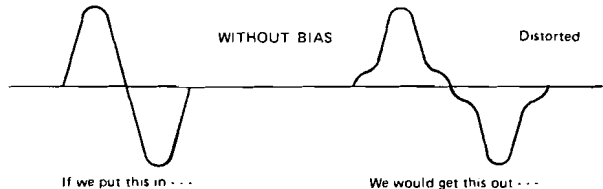

Fig. 23

The beginning and ending points of the wave would be distorted by the reluctance of the iron bits to change their magnetic state from one polarity to the other. Crossing that zero line takes extra energy. The Bias Signal provides it. We put in this:

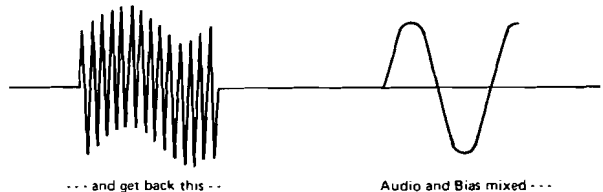

Fig. 24

Where did the 100 kHz go? It disappears from the output because the head gap is too large to play it back. The individual changes of magnetic energy on the tape are smaller than the gap size so a plus and a minus wave are both within the gap at the same time. They cancel out. Marvelous! On with the problems of alignment.

Well, maybe not so marvelous. Because of the fact that there is one amplifier doing 2 separate jobs. The adjustments we make on one circuit will affect the other. In fact, there are 3 interacting circuits and life can get pretty tricky right here. The 3 adjustables are (in sequence):

1. The erase current adjustment trim pot #7 R111, 1 kOhms ERASE & BIAS LEVEL.
2. The bias current (for the record head) trim pot #8 R112, 50 kOhms BIAS LEVEL the large blue one.
3. The bias traps. Since there is a lot of power involved here, you have 2 problems. The record bias signal must not go to the record electronics, only to the head so there is a big high frequency filter (very high, just to keep the bias out) on the wire to the record head.

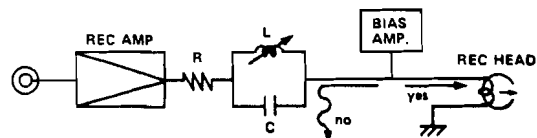
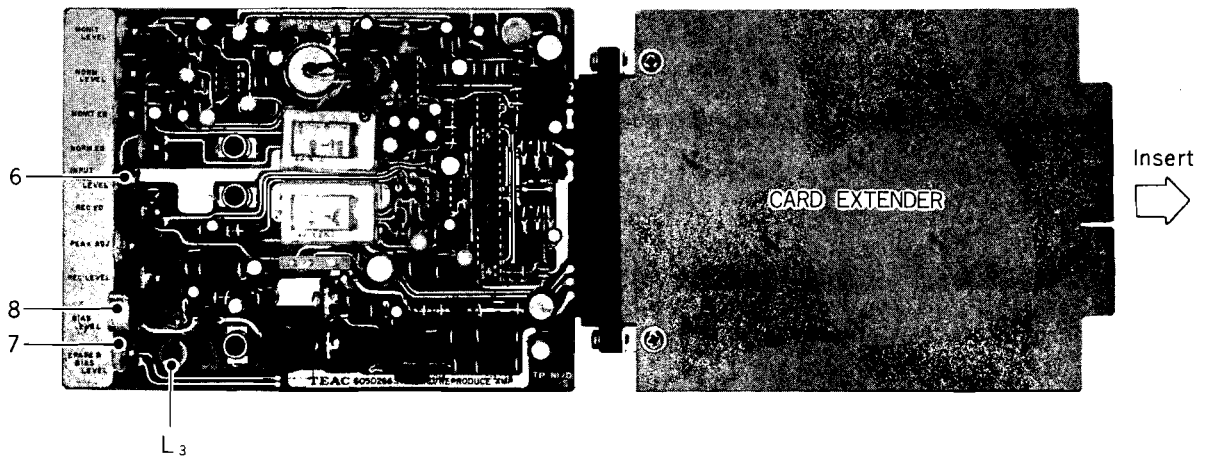

Fig. 25

THEORY OF OPERATION-MAINTENANCE(Continued)



Electrical Adjustment Procedure

These adjustable circuits are on the card inside, and the extender must be used if adjustments are necessary. We've given you the bad news (they interact). Now we'll give you the good news. Unless you adjust the erase current or the bias current by a very large amount, you won't need to check these circuits more than once every six months or so. The traps seldom need adjustment unless something is wrong with the master oscillator. The "traps" are expected to tune out the 100 kHz frequency that the bias oscillator is producing, and the range of adjustment that they have is not very good at filtering a much different frequency. If the master bias oscillator drifts, it must be re-adjusted to produce 100 kHz. Since this bias oscillator master circuit adjustment requires something expensive (very) called a frequency counter, it's wise to assume it's a dealer problem. Cart it in for this kind of service. There are also bias traps in the playback circuit to keep any stray leaks out of them as well, but they are not as touchy as the record-related circuit traps, and won't affect the load on the bias amplifier. They are tricky to adjust, but very stable. In sequence, you adjust them (if necessary) at the very end of the entire alignment procedure so we'll mention them again.

ERASE ADJUST:

Let's get back in sequence again. First — the erase adjust. The idea here is to make sure all signals come off the tape when you want them to, so you record a 1 kHz tone on the brand of tape you wish to use at 0 dB level, that's +10 VU, full saturation and then, erase it (record no input signal over the tone). While erasing, you read the output with the VTVM and a 1 kHz filter. Since the filter will "pass" only 1 kHz, you should get a reading of -65 dB. If the reading is higher than that, you need more erase current. Adjust trim pot #7 R111, 1 kOhms to correct the reading to -65 dB. This circuit does not require daily or weekly adjustment. Once every 6 months should do, unless you hear signal left on the tape when you are working. The filter is TEAC part No. M-206. You connect it between the recorder output and the meter (VTVM).

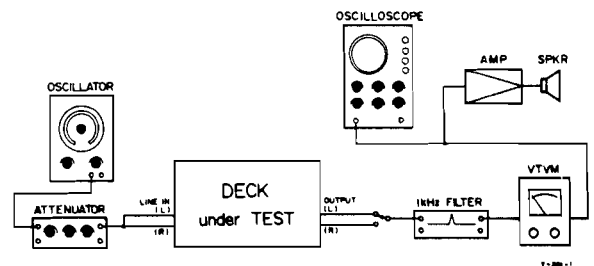

Fig. 26 Test Connections for Erase Measurement

BIAS LEVEL ADJUST: This adjustment is made while you are recording a tone on the type of tape you'll be using for the session. It will be different for each brand of tape.

Set up the signal generator (oscillator). The frequency is 10 kHz. The level should be 0 VU on the meters of the 80-8 on INPUT. Start the machine, record the signal, and switch to MONITOR on the OUTPUT SELECT.

Begin the adjustment by making sure trim pot #8 R112, 50 kOhms BIAS LEVEL is in the fully counter-clockwise position (off, no bias at all). Now, as you rotate the trim pot #8 clockwise, the VU meter will rise to some peak reading. Continue the clockwise rotation slowly until the reading on the meter drops back 3 dB from the peak. If, at peak the meter goes off scale, adjust the front panel input level control to keep the reading on scale.

What is important here is not the zero. It is the reduction of the peak by precisely 3 dB. If you have moved the input level pot on the front panel of the 80-8 to keep your reading on scale, the next adjustment will correct your input reference.

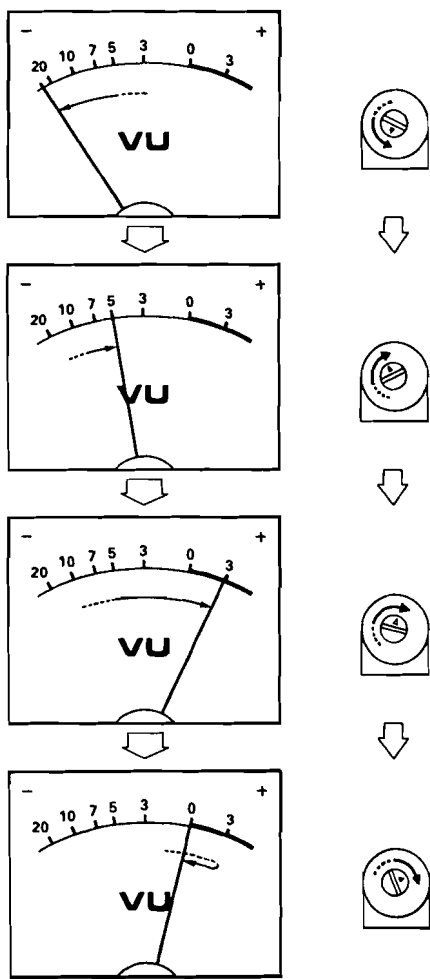

Fig. 27 Bias Level Adjustment Sequence

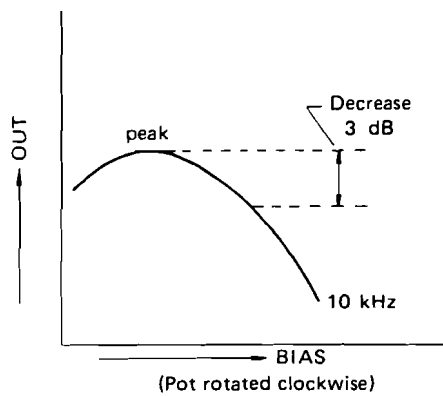

Fig. 28 Bias Limits Chart

If there is insufficient CW rotation of trim pot #8 to achieve a peak, dealer service of the Bias amplifier/oscillator system will be required. Many voltages in the circuit must be adjusted accurately and this type of problem is not considered to be "Daily Maintenance". Bring it in.

When doing bias adjustments, all 8 channels should be recording at once, even though you are adjusting only one at a time.

With the oscillator running at 1 kHz, switch back to INPUT. Adjust the front panel input knob to 2 o'clock position and adjust trim pot #6 R107 INPUT MONIT LEVEL for 0 VU indication on meters.

BIAS TRAP ADJUST:

Now is the time to do the bias trap in the record circuit: the card extender is used. With no input signal, test point is located on the card. Positive side of VTVM is connected to test point, negative side to ground. Tune inductor L3 for minimum.

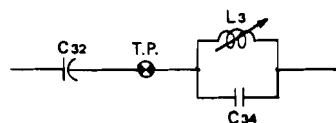
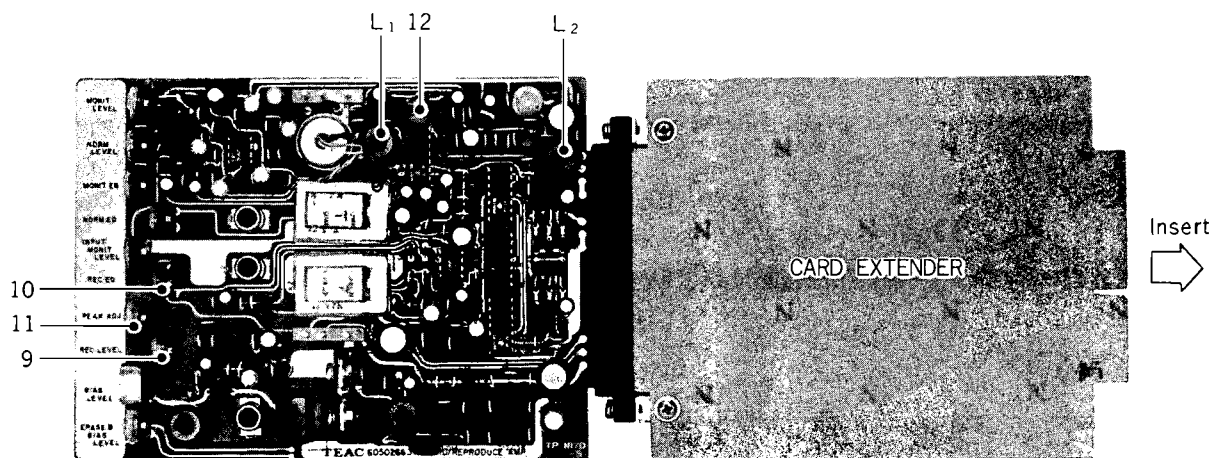

Fig. 29

THEORY OF OPERATION-MAINTENANCE(Continued)



Electrical Adjustment Procedure

RECORD LEVEL ADJUST:

We give these adjustments just to be accurate and thorough, and remind you again that they are seldom needed. Unless you have made some really drastic change in your recorder, you should not worry about this adjustment for at least 6 months.

Again, to be thorough, at this point it would be wise to check erase and bias again before proceeding. On a major overhaul it might be necessary to go through these 3 steps 3 or 4 times before finally moving on to the record equalization and then, once more from erase through to the end. Describing this procedure this way is probably giving the manufacturing setup, or a head replacement sequence when all values of the record circuit must be re-qualified. If noise is heard, signals don't erase completely even after adjustment, or there is not enough rotation of the bias trim pot left to get a "drop" in bias, the whole adjustment should be considered, but only under these unusual circumstances.

However, we do recommend that you select a brand of high quality tape and stick to it. Changing bias every day for different tapes will make the recorder cranky and a little harder to adjust. Constant messing with the controls is unwise. It is a much better idea to do as little as possible and let the recorder "settle in" to one kind.

We are now ready to adjust the record circuitry. We first check the low frequency input level at 1 kHz to get a reference. The steps are as follows:

1. Adjust oscillator to 1 kHz
2. Select "INPUT" on OUTPUT SELECT buttons
3. Send in .316 volt, set "0 VU" on 80-8 meter

4. Record the tone at 15 ips.
5. Switch to "MONITOR" read 80-8 meter
6. With trim pot #9 R110, 10 kOhms REC LEVEL, adjust to "0 VU".

With only a few adjustments remaining in the complete procedure, let's review all you have done up to this point. Step by step, you have:

1. Cleaned and degaussed the tape path.
2. Adjusted the head azimuth of both heads to 90° by checking and adjusting progressively higher and higher frequencies.
3. Checked the 80-8 meters against a precision meter and set .316 volt output as "0 VU" playback.
4. Adjusted playback from both playhead positions to be "0 VU" at 1 kHz and at 15 kHz, using the test tapes as an absolute reference of magnetic level.
5. Applied a reference level to the input of the 80-8 and adjusted the "0 VU" point to be .316 volt, both in the circuit and on the meter.
6. Set the erase level, using blank tape of your selected brand and type.
7. Set bias level for the tape of choice.
8. If you have the equipment, make sure no bias is going to the record amplifiers.
9. If you have the equipment, set (after bias) the record "0 VU" and read it off playback. You now know that the tape you are making has the same level of magnetic flux recorded on it as the reference alignment tape, but only at 1 kHz, the basic adjustment frequency — you now select 18 kHz and adjust trim pot #10 R108, 3.3 kOhms REC EQ, and read playback from the MONITOR position. Adjust to "0 VU". One setting remains.

The Peak Adjust Circuit

The trim pot in this circuit only has a very small range, $\frac{1}{2}$ dB. It is for final high end adjustment. The frequency to send in is 18 kHz, record the tone at "0 VU" in, switch to MONITOR and read the result. Adjust trim pot #11 R109, to read "0 VU" in playback.

Both of the record equalization circuits have rather a small range of adjustment. The high frequency adjust is 3 dB, the peak adjust is $\frac{1}{2}$ dB. If you can't seem to get a "good" reading because you run out of adjustment range, check these 3 points.

- The "Record adjust" (point #9 in this review). Re-do, send in "0 VU" at 1 kHz. Record the tone and read playback. If it is low, it will be impossible to get 15 kHz or 18 kHz up to "0 VU." Reset and try again. Still no good? Re-check the bias. If the bias current is too high, the high frequency sensitivity is reduced in relation to the 1 kHz point. Check it out.

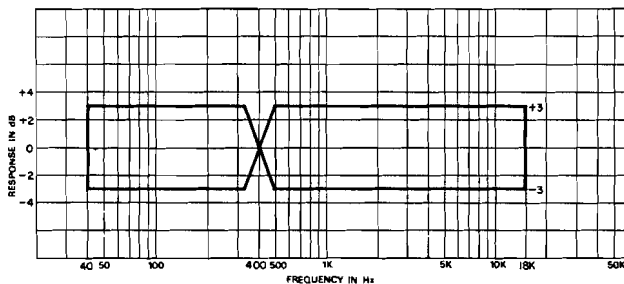

Fig. 30 Frequency Response-OVERALL

If all this fails to produce a reading that lies within the tolerances for frequency response on this graph, it is time to replace the heads. If more equalization were added to the record circuit to overcome wear, the boost needed would be large enough to make the Signal to Noise ratio specification impossible to achieve.

Let's assume everything is OK so far. You have sent in and read back good numbers for 15 ips, everything in spec at both frequencies. Now, as a check, record everything you have on your tone generator (if it is variable be reasonable, say 10 frequencies) 40 Hz, 100 Hz, 400 Hz, 1 kHz, 4 kHz, 10 kHz, 15 kHz, 18 kHz — compare with the graph above.

Fine tuning the bias against the frequency trim pots will allow you to get a little closer to perfectly flat. It's time consuming but worthwhile. Suit yourself.

Remember the bias traps? We've discussed the adjustment of the bias traps in the record circuit and what they do and now that we're done with the final changes to the record equalization, we can measure the Signal to Noise performance and tune the playback bias traps. Connect the VTVM to the output of the recorder. Use the card extender (Part 60853030). Locate the play bias traps L_1 , L_2 on the card. With the unit in RECORD but no signal other than the bias being recorded, adjust for a minimum reading on the TEST meter (VTVM).

While you have the extender card on the electronics we should describe the LED or peak reading adjustment. Examine the diagram/illustration to find the trim pot.

Switch the 80-8 to INPUT and send in a signal of 1 kHz at a level of 1 volt (0 dB, +10 VU). Adjust the trim pot #12 R106, 22 kOhms until the LED goes on.

We suggest that you do this LED adjustment as rapidly as possible. +10 VU is not good for the meter movement. More than one minute of operation at +10 may damage the armature, so set everything up before applying the signal and be brief.

With the 80-8 all buttoned up and the service door closed you can now check the Signal to Noise of the whole system. You use the big test meter. Record with no input signal and read the result. The reading should be -60 dB or better (un-weighted).

That's it. The whole procedure for an electronic overhaul of the 80-8. Mechanical adjustments such as brake and holdback torque, reel height adjust and wow and flutter measurements must be done first, but they are major service and should not be necessary "out of the box." The transport logic control and switching system are described in the service manual.

We'll sell you a copy if you want one, but digital i.c. theory is very complex and the necessary test equipment for repairs costs more than the recorder. The service manual is not written as a guide to the beginner, so be advised, it may not help your understanding of the 80-8. It is useful only to the experienced maintenance technician.

DAILY SETUP

It's obvious that this entire procedure is not something that can be completed quickly. You don't begin a "major" ten minutes before the musicians arrive. It is not likely to be necessary every day, but what is reasonable? Most good engineers make two quick tests. If nothing is amiss, they start setting up the rest of the session with confidence. If there is a problem, they go further. Here is what they do.

1. Clean and degauss. Obvious first step.
2. After the recorder has been on for 10 minutes and is nicely warmed up, they check the playback response with the test tape. A little trim? OK, no problem.
3. They then set up the signal generator and record several frequencies, say 100 Hz, 4 k, 10 k. Looks good? Then we can begin.
4. A very fussy engineer will take a look at the bias adjust to make sure everything is OK there as well, before he looks at the record EQ.

These three quick checks will usually uncover any serious troubles, and the idea is to work backwards up the chain of adjustments if anything shows an error. "Playback" is the first step in a major overhaul, and Record EQ is the last.

If everything works OK, you can assume all is well. If you get something funny as a reading, you will have to track it down, but these three tests will usually give you some idea of where the problem lies. Work backwards through the recorder (that's forward through the adjustments, by the way, they run from back to front in the procedure, don't get confused) until you uncover the problem. You always clean and degauss, and you should always check the playback response with the test tape. Again, playback, bias, record check, no problems, OK, go, and good luck with your tapes.

Speaking of tape, we strongly suggest that you buy good quality tape and stick to one kind. White box tape is cheap for a reason. It doesn't perform as well as the "good stuff," and will be hard to tune up to, and may even damage your recorder. Excessive shedding of oxide, uneven slitting and other defects too numerous to mention will make all your efforts go for very little. Tape is important, use the best.

It's awkward to flip pages in doing the test procedures, so we are including a chart of all the adjustments in their proper sequence on one page. Once you have the idea, all you need are the trimmer numbers and such. Here they are.

GENERAL ADVICE ON MAINTENANCE

Don't attempt to adjust a stone cold machine. Turn it on and let it warm up for 10 minutes.

Don't adjust the "traps" with a metal screw driver or tool. The metal tip will affect the value of the part and will give false readings. Use a plastic T.V. adjustment tool, or cut a strip of rigid plastic to size. (Credit cards will work, if you have an old one you don't need.)

Suspect any large change in adjustment that happens all at once.

Stop and think, if you turn a pot and get no change in reading, have you adjusted the wrong control?

Always turn the machine "off" when installing the extender card.

Remove the alignment tape from the heads when switching power "on" or "off." A switching transient on a badly adjusted recorder can "print" on the tape.

Tape and electronic "hiss" should be smooth sounding. If, when recording, you detect popping, or sputtering noises, degauss the heads. If this doesn't change the sound, plan on a record bias trap adjustment.

If the oscilloscope picture is not stable when using the alignment tape (the trace opens and shuts like a mouth) suspect the holdback torque adjustment. When recording and playing test tones, suspect the tape slitting as well as the motor adjusts. If the reference tape doesn't do this, but the recording tape does, it's definitely not the recorder. It is the tape that is at fault.

At the end of a session, take the time to slow wind (play) the roll off the machine and store it "tails out." This is the best way.

Don't plan on recording over a splice. Any steady tone such as singing, or violins that you attempt to print over a cut in the tape may show a dropout, or momentary

interruption. Even the best splice in the world is thicker than normal. The splicing tape adds quite a lot, and makes the tape "bump" when it goes by the head. This is especially important if you are using DBX. The dropout will be made much more noticeable by the action of the DBX.

It is a good idea to pad your master tapes by winding some blank tape on both ends, and adding leader tape.

Put a test tone (1 kHz) on each tape for reference level checks. Then it's easier to set up machines and mixers when recording sessions occur on different dates or different machines.

Keep a TRACK SHEET. Write down what happened during the session and what went on to the tape. You might list such things as mic placement; complete/incomplete takes; brand of tape used; speeds; noise reduction; comments (for example: a producer might have liked a particular bass part more than others, so you can save it and use it during overdubbing and mix-down).

Have the tools-of-the-trade handy — leader tape, razor blades, splicing tape, masking tape, grease pencils, etc.

There's another old saying around studio circles: if it's not labeled, use it. So it's a very good idea to label all tape boxes and reels. And pack a track sheet in every box.

When you're not working on a tape, it's safest to put it in its box; don't leave it on the machine where an accident could wipe out weeks of work.

Regardless of how well you maintain your 80-8, breakdown can occur at an unfortunate times. We strongly recommend that you purchase a spare electronics "card" for your 80-8. If one channel "goes down" a spare card will prove invaluable.

CONNECTION AND OPERATION OF THE DX-8

Hook-up. (see Fig. 31)

1. Remove the covering plate from the rear panel of the 80-8. (Refer to the Drawing No. 60372790.) Connect the remote cord from the DX-8 to the exposed terminal on the 80-8. Secure the backplate (attached to the remote cord) to the 80-8.
2. Connect the LINE OUT jacks of the 80-8 to the DECODE IN jacks of the DX-8.
3. Connect the LINE IN jacks of the 80-8 to the ENCODE OUT jacks of the DX-8.
4. Depending upon the number of busses and the monitoring facilities of your mixer, use the INPUT and OUTPUT jacks of the DX-8 to provide the connection between your mixer and the 80-8. (Connect mixer's line outs to DX-8 INPUT, etc.)
5. If necessary, use the GND terminal on the rear panel of the DX-8 to provide common grounding.
6. Connect POWER CORD to SWITCHED outlet of 80-8.

DBX Switch: IN activates the encode or decode circuits with respect to the FUNCTION SELECT buttons on the 80-8 (see RECORDING SECTION). OUT (up position) eliminates the DX-8 from operation by bypassing the encode/decode circuit. The OUT position is for reproducing non-DBX encoded tapes.

How the DX-8 functions.

Once you have the DX-8 connected, you may virtually ignore it. The unit works completely automatically. And, because of the design and nature of the DX-8 noise reduction unit, there is no need for record or play level match adjustments — the level is non-critical within nominal tolerances; the circuit is stable.

The DX-8 is designed to provide switchable encode-decode processing. This means there is only one noise reduction circuit (card) for each channel. The DX-8 does all switching internally and automatically. It is automatically switched to encode (record) when the 80-8 is placed in the record mode. When playback is desired on the 80-8, the noise reduction electronics are automatically switched to the decode (playback) mode.

To illustrate how the DX-8 functions, note the following examples.

EXAMPLE 1. Original recording.

Suppose you are going to record on four tracks. With the OUTPUT SELECT in the NORMAL position, depress FUNCTION SELECT buttons 1 thru 4. The LED indicators will blink, signaling ready-to-record on these tracks. Enter RECORD with the transport controls and the LEDs will remain lit. At the same time, the red LEDs on the DX-8 are lit, indicating encode processing on these channels.

Also, the DX-8 automatically sends the input signal to the output terminals. Thus the signal going to the tape is encoded, but the signal which you are monitoring is pre-encode (source).

EXAMPLE 2. Overdubbing.

In this example, suppose you have recorded on tracks 1 thru 4, and now wish to record on tracks 5 thru 8, in sync.

Set up the OUTPUT and FUNCTION SELECT buttons in the same manner as in Example 1. The DX-8 will auto-

80-8 Rear

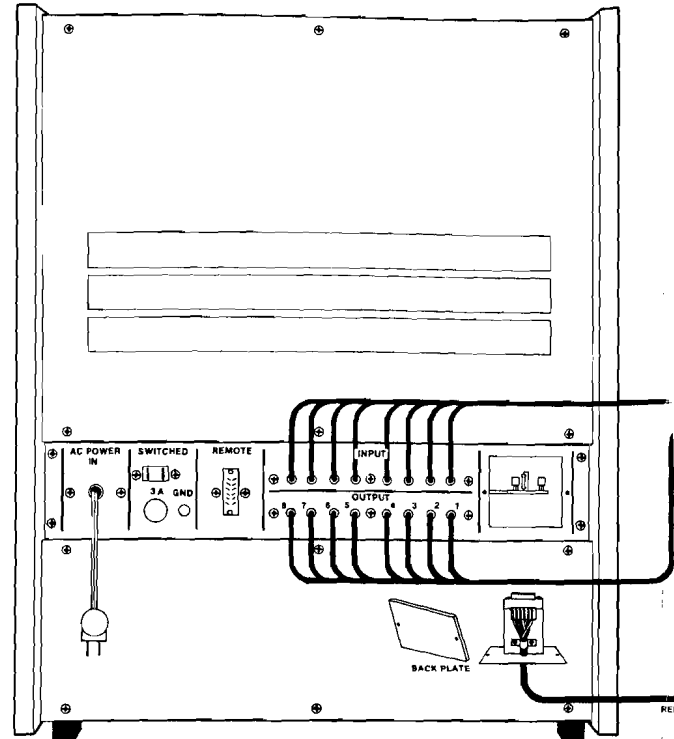

Fig. 31 DX-8 Connection

matically encode the signals going to tracks 5 thru 8, and decode the signals on tracks 1 thru 4.

The same process occurs when you punch-in during any recording session. When the 80-8 is in the record mode, the DX-8 is encoding; in playback (sync monitoring), it's decoding.

Some recording precautions.

Mixing: Program material must be in uncompressed form for mixing and sound-on-sound recording. You must first decode the program material which has been encoded by the DX-8 in order to mix it with any other material. Of course, mixed material may be compressed again for recording. If this precaution is not followed, you'll get cross-modulation of the separate signals or tracks.

Subsonics and Interference: The DX-8 incorporates an effective bandpass filter with -3dB response at 20Hz and 30kHz. This filter suppresses undesirable sub- and super-sonic frequencies to keep them from introducing errors into the encode or decode process. However, if rumble from trains or trucks, for example, is picked up by your microphone and fed to the DX-8, modulation of the program material during low level passages may occur. This low frequency component will not itself be passed through the recorder and so, will not be present at playback for proper decoding. If this low level decoding error is encountered, and subsonics are suspected, we suggest the addition of a suitable high pass filter ahead of the DX-8 and after the mic preamplifier for further attenuation of these subsonic frequencies.

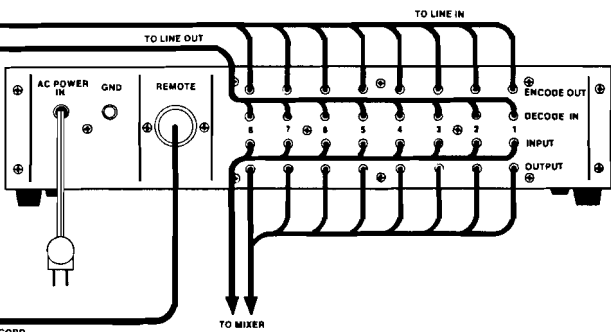
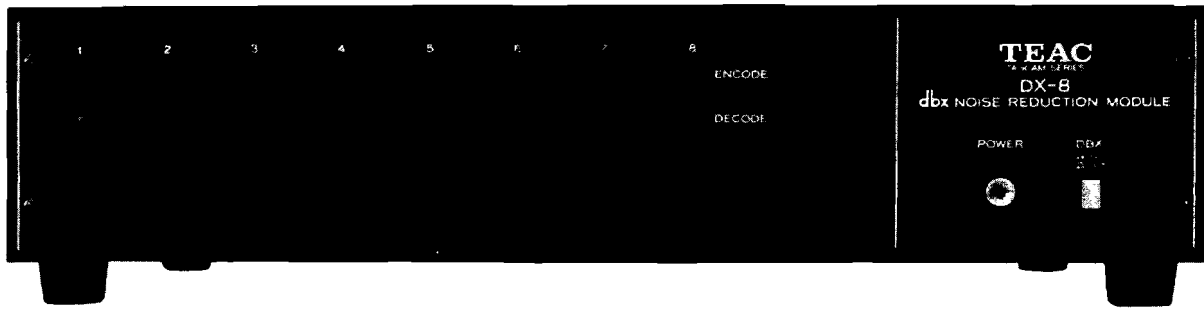

HOW THE DX-8 WORKS-THEORY

The DX-8 is a wide-band compression-expansion system which provides a net noise reduction (broadband, not just hiss) of a little more than 30 dB. In addition, the compression during recording permits a net gain in tape headroom of about 10 dB.

A compression factor of 2:1 is used before recording; then, 1:2 expansion on playback. These compression and expansion factors are linear in decibels and allow the system to produce tape recordings with over a 100 dB dynamic range — an important feature, especially when you're doing live recording.

The DX-8 employs RMS level sensors to eliminate compressor-expander tracking errors due to phase shifts in the tape recorder, and provide excellent transient tracking capabilities.

To achieve a large reduction in audible tape hiss, without danger of overload or high frequency self-erasure on the tape, frequency pre-emphasis and de-emphasis are added to the signal and RMS level sensors.

If you're an electronic engineer, all of the above gab may tell you the whole story of what's going on in the DBX, but if you're not, to make things a little easier to understand we'll ask you to use your imagination.

Imagine four little recording engineers in the box with their hands on a volume control each. They are incredibly fast but very stupid, so you must give them a set of rules. You tell them to raise signals that are below "0 VU," and reduce signals that are higher than "0 VU."

The lower the signal is, the more they raise it, and the higher levels above "0 VU" get lowered more and more as they go up in level past "0." This is the 2:1 compression. You also tell them to call ".316 volt" "0 VU." Here they do nothing, no change except frequency pre-emphasis or boost. Since you know they are going to keep the high levels under control, you can raise the "top end" a bit and still not overload the tape. Just to keep it simple for them, the boost in highs is fixed. They put it in all the time, no matter what level changes they are making. Now we play the tape back, and say OK, do everything backwards. Levels above ".316 volt" "0 VU" are raised and levels below ".316 volt" are lowered, and while you're at it, fellows, take off the extra top end as well. Follow the rules in reverse. As long as you don't confuse them by shifting the "0 VU" point, they work just great, but — don't put in more than ".316 volt" as zero VU, and don't

Recording Levels: Since you have more than adequate dynamic range, you can record at slightly lower levels than normal. This lower recording level, along with the 80-8's excellent signal-to-noise ratio (95dB with DX-8), insure lower distortion and more headroom.

NOTE: Tapes recorded without the DX-8 may seem to have a brighter sound due to the increase of background tape hiss with increasing recorded signal level. Your ears may interpret this hiss as higher order harmonics of the recorded frequencies. Thus, recordings made with noise reduction may not sound as bright in comparison with recordings made without noise reduction. But a careful comparison between the noise reduced tape and a recording made without noise reduction, to the original live material, will show that the noise reduced recording is identical with the original.

make the tape playback zero anything other than ".316 volt" either. As we said they're very dumb and will follow instructions very precisely. Differing levels will produce decoding errors.

The reason these errors may not be objectionable is that people could have played or sung or whatever with a little more or less dynamics. A small change won't be noticeable as a mistake, but it is not perfect. The tolerance here is not electronic, it's human. To get exactly what you put in, it is necessary to get an exact "0 VU," .316 volt in and out. The system is level sensitive although it is realistic to say it is "artistically" forgiving.

ENTERING "RECORD"

OUTPUT SELECT BUTTONS: The signal presented at the output terminals is controlled by the OUTPUT SELECT buttons.

INPUT will typically be used for source calibrations during system interface and set-up procedures. When this button is depressed, the input signals are sent directly to the output terminals.

MONITOR will present the monitor head signal to the output jacks for those situations where it is desirable to monitor the printed signal on the tape for reference during the recording.

NORMAL will be used for most operations: recording, overdubbing (sync), and reproduce. The monitoring status is then determined by the FUNCTION SELECT buttons.

FUNCTION SELECT BUTTONS: When the OUTPUT SELECT is in either the INPUT or MONITOR position, the FUNCTION SELECT buttons have the single purpose of determining the record status. UP is safe. DOWN is ready-to-record.

When the OUTPUT SELECT is in the NORMAL position, the FUNCTION SELECT buttons serve two purposes: (1) they determine the record status — UP is safe, DOWN is ready-to-record, and (2) they determine the monitoring status — UP is sync/tape reproduce; DOWN is source.

There are 3 ways to enter record

1. With the OUTPUT select in the NORMAL position, depress the FUNCTION SELECT buttons for those tracks on which you wish to record. The blinking LEDs will indicate ready-to-record on those particular tracks. Enter record with the TRANSPORT CONTROLS — depress RECORD (LED will light) and PAUSE together. Then push PLAY and all of the FUNCTION SELECT LEDs will remain lit until the record mode is deactivated.
2. To facilitate puch-ins, the logic can be reversed by first setting FUNCTION SELECT button in the UP position and entering record with the RECORD and PLAY buttons. Now the record LED will blink, indicating ready-to-record, and are monitoring sync/tape reproduce. At the appropriate time, depress the FUNCTION SELECT button(s) for the tracks you wish to punch-in, and you enter record while simultaneously switching the monitor to source.

Now, imagine two different occasions where it is desirable to punch-in a correction on a given track, instead of recording the entire part all over again. If the correction needs to be made at the BEGINNING of the tune — say a hesitant start that is slightly out of sync with the downbeat — then there is no need to monitor reproduce (sync) since the bad start will only serve to confuse the musician. Indeed, that part of the track will be re-recorded.

So the punch-in is straightforward enough: enter the record mode on the appropriate track with the corresponding FUNCTION SELECT button. Press the record button when the slate occurs — at the beginning of the tune — then enter stop at a convenient, appropriate time, after the punch-in is completed.

EXAMPLE 2: In this situation, suppose an error has been made near the end of the tune — or in the middle — the example is still valid. Now the musician will likely need to hear his performance up to that point so that the punch-in does not represent a different style

or feel, and therefore, is consistent with the rest of the performance. In this case, enter record ready by pressing the record and play buttons simultaneously. The record mode will be activated when a FUNCTION SELECT button is depressed.

When the FUNCTION SELECT is in the UP position, the musician will be monitoring reproduce (sync) and probably play along with the previous performance until the time comes to punch-in the correction. When that moment occurs, simply press the appropriate FUNCTION SELECT button for the corresponding track that is ready to be recorded. Two things then happen. First, you instantly enter the record mode on that track, and the new part will replace the previous one, in sync of course. Second, the monitor is automatically switched from tape (UP position) – sync reproduce – to source (DOWN position) – so the musician can hear his new part as it is being added. The logic remains consistent.

3. For very brief “punch-in,” if you can “cue” or find the spot to begin re-recording by listening to other tracks – depress FUNCTION SELECT to the READY position, put the transport in PLAY. For short segments you can now press RECORD and hold it down. The recorder will stay in the RECORD mode as long as you hold down the RECORD button. When you release it, the tape will play, but will not be erased. This mode will allow you to re-record small parts of a track that are separated by sections you wish to keep quickly, but since you cannot hear what’s on the tape, it can be risky. You can also enter and leave the record mode by raising and lowering the function select buttons while the transport is “locked” in the RECORD mode. It’s not necessary to enter STOP to stop recording. This is called “punch and roll” and is sometimes very useful. Again it is risky because you run the risk of waiting too long to “punch out.” Be careful.

SPECIFICATIONS

TAPE WIDTH	½ inch
FORMAT	8-track, 8-channel
REEL SIZE	10½" maximum, NAB hub only
TAPE SPEED	15 ips
LINE INPUT	-10 dB (0.3V) Impedance: greater than 20k Ohms, unbalanced
LINE OUTPUT	-10 dB (0.3V) Load impedance: greater than 10k Ohms, unbalanced
RECORD LEVEL	0 VU referenced to 3 dB above
CALIBRATION	185 nWb/m of tape flux, adjustable
SPEED ACCURACY	±0.5% deviation from 15 ips
WOW and FLUTTER	0.04% RMS (NAB), weighted ±0.06 peak (ANSI), weighted Measured with flutter test tape.
STARTING TIME	less than 0.5 sec.
FAST WIND TIME	120 sec. for 2400 ft. of tape
OVERALL FREQUENCY RESPONSE, SYNC SIGNAL to NOISE	40 Hz – 18 kHz, ±3 dB 65 dB weighted, 60 dB unweighted, referenced to 3% T.H.D. level (10 dB above 0 VU) at 400 Hz
DISTORTION	1% at 400 Hz, 0 VU
T.H.D. overall	3% at 10 dB above 0 VU
CROSSTALK	greater than 45 dB at 400 Hz
ERASURE	greater than 65 dB at 1 kHz, +10 VU reference
POWER REQ.	117 V, 60 Hz, 200 W (U.S.A. Model) 220 V, 50/60 Hz, 200 W (Europe Model) 240 V, 50/60 Hz, 200 W (U.K./Australia Model)
DIMENSIONS overall	17½" (W) x 21" (H) x 12" (D) [445 (W) x 535 (H) x 305 (D)mm]
WEIGHT	76 lbs. [35 kg]

- Performance of U.S.A. Model measured with Ampex 456 tape.
- Performance of other models measured with Scotch 206 tape.
- Changes in specifications and features may be made without notice.
- Value of “dB” in the Data refers to 0 dB = 1V, except where specified. If a Test Set or VTVM calibrated to 0 dB = 0.775V is to be used, appropriate compensation should be made. For example, -10 dB (0.3V) is applied to the line in jacks, the VTVM which is connected at the line output jacks reads -7.8 dB (0.3V) instead of -10 dB (0.3V).

TEAC.

TEAC CORPORATION 3-7-3, NAKA-CHO, MUSASHINO, TOKYO PHONE: (0422) 53-1111

TEAC CORPORATION OF AMERICA 7733 TELEGRAPH ROAD, MONTEBELLO, CALIFORNIA 90640 PHONE: (213) 726-0303

60090152-00

PRINTED IN JAPAN 0478SA.85 D-2404