

KENWOOD

144/440MHz FM DUAL BANDER

TH-75A

144/430MHz FM DUAL BANDER

TH-75A

144/430MHz FM DUAL BANDER

TH-75E

INSTRUCTION MANUAL

KENWOOD CORPORATION

©PRINTED IN JAPAN B50-8275-00(K, M, X, W, T, P)(T)
90/12 1110 9 8 7 6 5 4 3 2 1 89/12 1110 9 8 7 6 5

Downloaded by
Amateur Radio Directory

www.hamdirectory.info

CONTENTS

1. BEFORE OPERATION	2
2. SPECIFICATIONS and ACCESSORIES	3
3. BATTERY PACK	4
4. OPERATION	
OPERATING CONTROLS	6
RECEIVER OPERATION	11
Reception, Frequency selection, Frequency step selection, Programable VFO, A.B.C.	
TRANSMITTER OPERATION	15
MEMORY	16
Microprocessor memory back-up, Microprocessor initialization, Memory channel, Memory contents, Memory entry, Memory recall, Memory shift	
SCAN	19
Scan operations, Hold/resume programming, Band scan, Programmable band scan, Memory channel scan, Double memory scan, Memory channel lockout, Priority alert	
REPEATER OPERATION.....	23
Transmitter offset, Reverse function, Tone and CTCSS operation, Autopatch	
TONE ALERT SYSTEM.....	26
BATTERY SAVER	27
AUTOMATIC POWER OFF.....	27
FAST SQUELCH.....	28
5. BLOCK DIAGRAM and SCHEMATIC DIAGRAM.....	another sheet
6. MAINTENANCE	29
In Case of Difficulty	
7. OPTIONAL ACCESSORIES.....	31
CTCSS unit TSU-6	

1. BEFORE OPERATION

Thank you for purchasing this new transceiver.

IMPORTANT:

Please read this instruction manual carefully before placing your transceiver in service.

CAUTION:

Long transmission or extended operation in the HI power mode might cause the rear of this transceiver to get warm. Do not place the transceiver where the heat sink (rear panel) might come in contact with plastic or vinyl surfaces. Use of an external antenna for fixed station is recommended.

SAVE THIS INSTRUCTION MANUAL.

This Instruction Manual covers the following models.

- TH-75A : 144/440 MHz FM DUAL BANDER with CTCSS unit.
(U.S.A. and Canadian version)
- TH-75A : 144/430 MHz FM DUAL BANDER.
(Other market)
- TH-75E : 144/430 MHz FM DUAL BANDER.
(U.K. and European version)

The following explicit definitions apply in this manual:

NOTE : If disregarded, inconvenience only, no risk of equipment damage or personal injury.

CAUTION: Equipment damage may occur, but not personal injury.

2. SPECIFICATIONS and ACCESSORIES

2-1. SPECIFICATIONS

		2 m Band	70 cm Band	
FREQUENCY RANGE (MHz)	TH-75A U.S.A. version	144 to 148	438 to 450	
	TH-75E European and U.K. version	144 to 146	430 to 440	
	TH-75A Others	144 to 148	430 to 440	
MODE		F3E (FM)		
MEMORY CHANNELS		10+1	10+1	
FREQUENCY STEP (kHz)		5, 10, 15, 20, 12.5, 25		
ANTENNA IMPEDANCE (Ω)		50		
POWER REQUIREMENT		6.3 - 16 (7.2 VDC nominal)		
GENERAL CUR- RENT DRAIN	TRANSMIT mode	13.8 V	Approx. 1.4 A	Approx. 1.5 A
		HI 9 V (with BT-6)	Approx. 1.2 A	Approx. 1.3 A
		7.2 V (with PB-5/6/7/9)	Approx. 1 A	Approx. 1.1 A
	Single band	LO transmit mode	Approx. 0.6 A	Approx. 0.6 A
		RECEIVE mode with no signal	Approx. 45 mA	Approx. 50 mA
		BATTERY SAVER mode	Approx. 12 mA	Approx. 13 mA
	Dual band	RECEIVE mode with no signal	Approx. 83 mA	
		BATTERY SAVER mode	Approx. 20 mA	
		AUTOMATIC POWER OFF mode	Approx. 3 mA	
	GROUND		Negative	
DIMENSIONS (W x H x D)	Projections not included (mm)	58 x 179 x 29.5 (2.3 x 7 x 1.2 inch)		
	Projections included (mm)	74 x 193 x 40 (2.9 x 7.6 x 1.6 inch)		
WEIGHT (g) With NiCd Battery and Antenna		510 (1.1 lbs.)		
OPERATING TEMPERATURE		-20°C ~ +50°C (-4°F ~ 122°F)		
MICROPHONE IMPEDANCE		2 kΩ		
TRANSMITTER OUTPUT POWER	HI	13.8 V	More than 5 W	
		9 V (with BT-6)	Approx. 3 W	Approx. 2.5 W
		7.2 V (with PB-5/6/7/9)	Approx. 1.5 W	Approx. 1.5 W
	LO	Approx. 0.5 W		
MODULATION		REACTANCE		
MAXIMUM FREQUENCY DEVIATION (kHz)		±5		
SPURIOUS RADIATION		HI/LO Less than -60 dB/-50 dB		
CIRCUITRY		DOUBLE CONVERSION SUPERHETERODYNE		
INTERMEDIATE FREQUENCY	1st IF (MHz)	16.9	59.525	
	2nd IF (kHz)	455		
SENSITIVITY 12 dB SINAD		Less than 0.16μV	Less than 0.18μV	
SQUELCH SENSITIVITY		Less than 0.1 μV		
SELECTIVITY	-6 dB	More than 12 kHz		
	-40 dB	Less than 28 kHz		
AUDIO OUTPUT POWER (across 8 Ω load 10% distortion)		More than 400 mW/at 9 V		

NOTES:

1. Circuit and ratings are subject to change without notice due to advancement in technology.
2. Recommended duty cycle: 1 minute Transmission, 3 minutes Reception

2-2. ACCESSORIES

Unpack your new transceiver carefully, and examine it for visible damage. If the equipment has been damaged in shipment, notify the transportation company immediately.

Save the boxes and packing material for future shipping.

The following accessories should have been included in the box with the transceiver.

AntennaT90-0388-05 ...1 ea.
 Belt HookJ29-0424-04 ...1 ea.
 Hand strap.....J69-0312-04 ...1 ea.
 NiCd Battery pack (PB-6)...W09-0507-05...1 ea.
 Battery charger.....1 ea.

for U.S.A. version (120V)
W09-0382-15
 for European version (220V)
W09-0388-05

for U.K. version (240V)....W09-0387-05
 for Oceania version (240V)
W09-0386-05

for other market (120V)...W09-0385-05

Instruction ManualB50-8275-XX .1 copy
 Warranty Card.....1 ea.
 (U.S.A., Canada, and European version)

3. BATTERY PACK

3-1. NiCd BATTERY PACK (PB-6)

This battery pack has not been charged at the factory in order to provide you with the greatest number of charge/discharge cycles. You must charge the battery before use. The battery pack will require several charge/discharge cycles before you can expect to see the maximum operating period between charges. If the battery will be stored for greater than 2 months it should be recharged before use.

3-2. RECHARGING

1. Slide the adapter onto the NiCd battery pack.
2. Plug the supplied charger into an AC outlet.
3. Do not allow the battery to charge for greater than 15 hours.

The useful life and battery performance will be reduced if you exceed the recommended charge period.

NOTE:

Recharging should be performed within an ambient temperature range of between 5°C ~ 40°C (41°F ~ 104°F).

Recharging the battery outside of this range may not allow the battery to reach full charge.

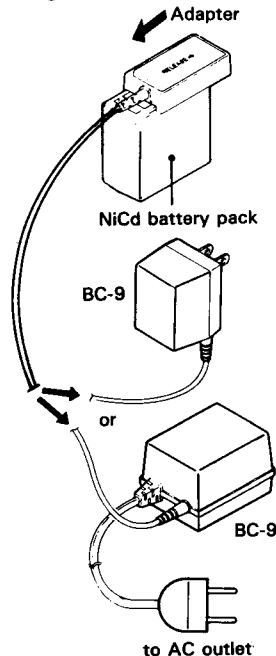

3-3. MANGANESE or ALKALINE BATTERIES

(Optional Battery Case BT-6)

Install 6 × R6 (AA) manganese or alkaline batteries in the battery holder. Pay close attention the battery polarities marked in the holder. We recommend the use of high performance manganese batteries for the greatest operating time.

NOTE:
Do not install NiCd batteries and attempt to charge them with the supplied charger. There is no battery protection circuit in the battery holder.

Press down on the hook in the middle of the battery case top to open.

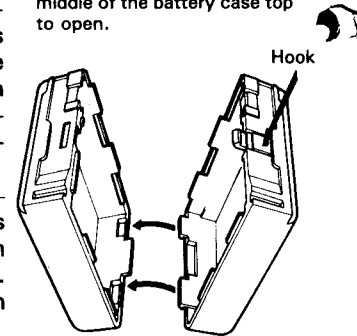

3-4. INSTALLING THE BATTERY PACK

Align the grooves in the battery pack with the transceiver and slide the pack to the right until it locks in place. To remove the battery pack push up on the release button and slide the pack to the left.

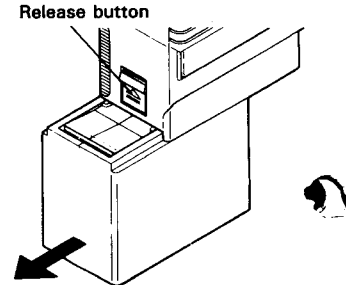

3-5. BATTERY VOLTAGE LEVEL METER

The S meter indicates the relative battery voltage during transmit.

Recharge or replace the batteries when the level reaches the low indicator.

Manganese or Alkaline batteries

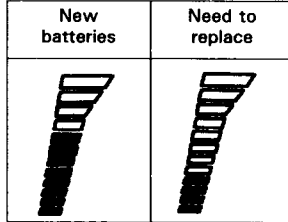

Approximate battery condition

NiCd Battery pack

model	mAh	V	Fully charged	Fully discharged
PB-5 PB-6 PB-9 PB-7	200 600 600 1100	7.2		
PB-8	600	12		

3-6. OPERATING TIME

TH-75 series

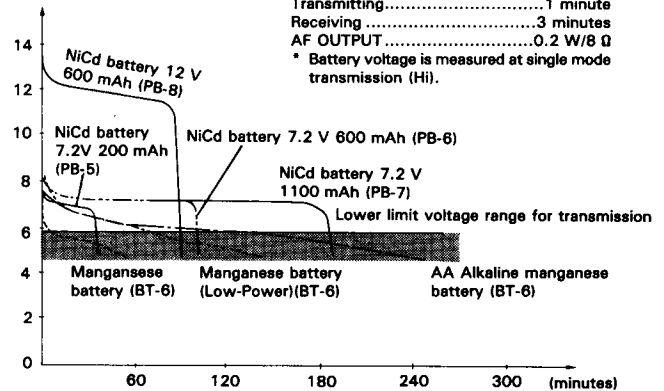

We recommend use of the NiCd battery pack for long transmission or extended operation. Manganese battery (except Alkaline manganese battery) is suitable only for LOW power transmission.

4. OPERATION

4-1. OPERATING CONTROLS

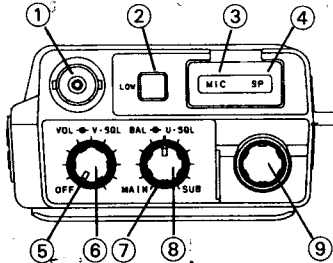

- ① **Antenna connector:**
Connect the antenna that is supplied to this jack. Twist to lock.
- ② **HI-LO switch**
This switch is used to select the transmit output power.
- ③ **MIC jack**
This jack is used for connection of an external microphone. The use of an electret type microphone is recommended.
Input impedance is 2 k Ω and the DC voltage on this terminal is approximately 4 V (max. 3.5 mA).

NOTE:

The use of a dynamic microphone is not recommended.

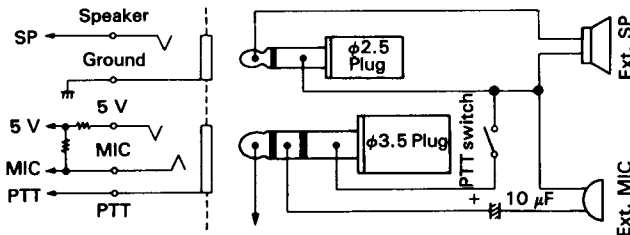

- ④ **Speaker jack**
This jack is used to connect an external speaker or ear-phone. The recommended impedance is 8 Ω .
- ⑤ **VHF SQL control**
This control is used to select the desired SQL threshold level of the VHF frequency band.
- ⑥ **VOL control/Power switch**
The volume control and power switch are combined. Rotating the control clockwise will turn ON the transmitter. Advancing the control further clockwise will increase the volume of both bands. The BAL control proportions the volume among the two bands.
- ⑦ **UHF SQL control**
This control is used to select the desired SQL threshold level of the UHF frequency band.
- ⑧ **BALANCE control**
This control proportions the total audio volume among the two bands.
MAIN position : Audio only from the MAIN band
Center position : Equal audio from both bands
SUB position : Audio only from the SUB band
- ⑨ **Tuning control**
This control is used to select the desired transmitter/receiver frequency, memory channel, frequency step, tone frequency, and scan direction.

Downloaded by
Amateur Radio Directory

www.hamdirectory.info

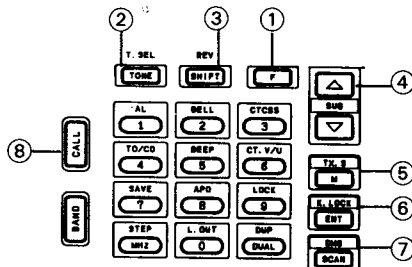
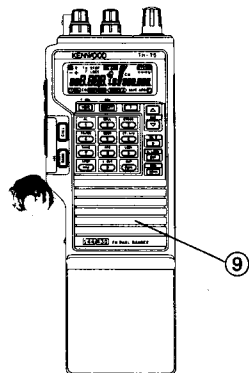

① F key

This key is used to activate control of the functions printed above the various front panel controls. The "F" indicator will turn ON for approximately 10 seconds. You must press the desired 2nd function key before the indicator turns off.

② TONE/T.SEL key

This key is used to activate the subaudible tone encoder. Pressing the key within 10 seconds of pressing the F key will switch to the tone frequency selection mode. The Tuning control can then be used to select the desired tone frequency.

③ SHIFT/REV key

This key is used to select the desired transmitter offset direction. Pressing the key will cause the radio to shift from one offset direction to the other, i.e. + to - to simplex where no indicator shows. [- to -- for European version (UHF band)].

Pressing the key within 10 seconds of pressing the F key will reverse the transmit/receive frequency during repeater operations. If you have selected simplex this key will not function.

④ UP/DWN (Sub tuning) keys

These keys are used to select the desired SUB band receive frequency or Memory channel.

Pressing the UP key within 10 seconds of pressing the M key will enter the upper limit for the programmable VFO tuning limit function. Pressing the DWN key within 10 seconds of pressing the M key will enter the lower limit for the programmable VFO tuning limit function.

⑤ M/TX.S key

This key and numeric key are used to store the displayed data into memory.

Pressing the key within 10 seconds of pressing the F key will turn the TX.STOP function ON and OFF.

⑥ ENT/K.LOCK key

In the VFO mode this key is used to switch to the direct keyboard frequency entry mode.

In the MR or CALL channel mode this key is used to transfer the contents of the channel to the VFO mode (Memory shift).

Pressing the key within 10 seconds of pressing the F key will deactivate all functions except the PTT, MONI, LAMP, F then LOCK keys.

⑦ SCAN/DMS key

This key is used to start or stop scanning. Pressing the key within 10 seconds of pressing the F key will start or stop Double Memory Scanning.

⑧ CALL key

This key is used to activate the Call channel function.

⑨ MICROPHONE

① **BAND/A.B.C. (Automatic Band Change) key**

This key is used to exchange the contents of the MAIN and SUB band.

When this key is pressed within 10 seconds of pressing the F key, the contents of the SUB band will be transferred to the MAIN band whenever a signal is received at the SUB band, which is strong enough to open the squelch. The contents of the MAIN band are transferred to the SUB band at the same time.

② **MHz/STEP key**

This key is used to tell the microprocessor that you wish to increase or decrease the operating frequency in 1 MHz increments.

During VFO operation pressing the key within 10 seconds of pressing the F key will switch to the frequency step selection mode.

③ **DUAL/DUP key**

This key is used to turn the SUB band ON or OFF. Pressing the key within 10 seconds of pressing the F key will cause the duplex function to activate.

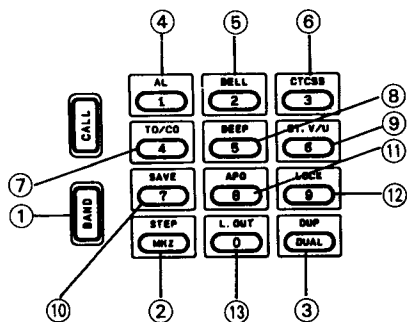

④ **1/AL key**

This key is used to turn memory channel 1 ON or OFF. Pressing the key within 10 seconds of pressing the ENT key will enter number 1.

Pressing the key within 10 seconds of pressing the F key will check Memory Channel 1 at approx. 5 second intervals. If the channel is busy, a beep will sound.

⑤ **2/T.ALT key**

This key is used to turn memory channel 2 ON or OFF. Pressing the key within 10 seconds of pressing the ENT key will enter number 2.

Pressing the key within 10 seconds of pressing the F key will turn the Tone Alert function ON or OFF.

⑥ **3/CTCSS key**

This key is used to turn memory channel 3 ON or OFF. Pressing the key within 10 seconds of pressing the ENT key will enter number 3.

Pressing the key within 10 seconds of pressing the F key will turn the CTCSS function ON or OFF.

⑦ **4/TO/CO keys**

This key is used to turn memory channel 4 ON or OFF. Pressing the key within 10 seconds of pressing the ENT key will enter number 4.

Pressing the key within 10 seconds of pressing the F key will toggle the hold/resume mode alternately from Time Operated scan to Carrier Operated scan.

⑧ **5/BEEP key**

This key is used to turn memory channel 5 ON or OFF. Pressing the key within 10 seconds of pressing the ENT key will enter number 5.

Pressing the key within 10 seconds of pressing the F key will turn the audio confirmation beep ON or OFF.

⑨ **6/CT V/U key**

This key is used to turn memory channel 6 ON or OFF. Pressing the key within 10 seconds of pressing the ENT key will enter number 6.

Pressing the key within 10 seconds of pressing the F key will switch the CTCSS function alternately between the VHF band and UHF band.

⑩ **7/SAVE key**

This key is used to turn memory channel 7 ON or OFF. Pressing the key within 10 seconds of pressing the ENT key will enter number 7.

Pressing the key within 10 seconds of pressing the F key will turn the Battery Saver function ON or OFF.

⑪ **8/APO key**

This key is used to turn memory channel 8 ON or OFF. Pressing the key within 10 seconds of pressing the ENT key will enter number 8.

Pressing the key within 10 seconds of pressing the F key will turn the Automatic Power OFF function ON or OFF.

⑫ **9/LOCK key**

This key is used to turn memory channel 9 ON or OFF. Pressing the key within 10 seconds of pressing the ENT key will enter number 9.

Pressing the key within 10 seconds of pressing the F key will deactivate the Tuning control and all functions except the PTT, MONI, LAMP, and F then K.LOCK keys.

⑬ **0/L.OUT key**

This key is used to turn memory channel 0 ON or OFF. Pressing the key within 10 seconds of pressing the ENT key will enter number 0.

Pressing the key within 10 seconds of pressing the F key will turn the memory channel lock out function ON or OFF.

⑭ **MONITOR switch**

When operating in the CTCSS mode you can use this key to determine if the frequency is in use before transmitting. Pressing the key will disable the CTCSS function as long as the key is held depressed.

⑮ **Lamp switch**

This switch is used to control the night lamp on the display. The lamp will turn itself off automatically 5 seconds after the last key operation.

⑯ **PTT switch**

Press this switch whenever you wish to transmit.

⑰ **Release button**

Press this button up to release the battery pack.

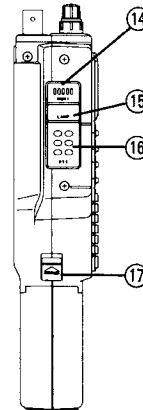

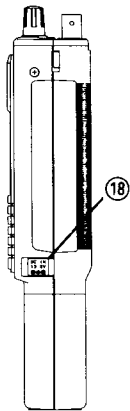

18 DC IN terminal

This terminal is used for an external power supply. Input voltage is 13.8 VDC nominal. The center is the + side and the sleeve is - side.

CAUTION:



You should turn the power switch OFF when connecting this terminal. Pay close attention to the polarity.

As a precaution, do not remove the battery pack when an external power supply is used.

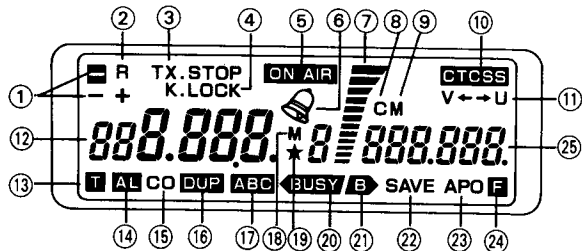
Use the KENWOOD PG-2V or PG-3E optional cable for the connection.



- ① **- +** Displays the selected transmitter offset direction.
- ② **R** ON when the Reverse function is active.
- ③ **TX.STOP** ON when the TX.STOP function is active.
- ④ **K.LOCK LOCK** ON when the K.LOCK function is active.
ON when the LOCK function is active.
- ⑤ **ON AIR** ON during transmit.

- ⑥  ON when the Tone Alert System is active. The indicator will flash when a signal is received.
- ⑦  This level meter indicates the relative receive input strength or battery voltage level during transmit.
- ⑧ **C** ON when the SUB band frequency displays CALL channel.
- ⑨ **M** ON when the SUB band frequency displays a memory channel.
- ⑩ **CTCSS** ON when the CTCSS function is active.
- ⑪ **V ← → U** Displays the selected CTCSS band.
- ⑫  Displays the operating frequency to the nearest kHz, the frequency step size, or the tone frequency of the MAIN band.
ON when the Fast Squelch function is active.
Flashes when Scanning.
- ⑬ **T** ON when the Tone function is active.
- ⑭ **AL** ON when the Priority Alert system is active.
- ⑮ **CO** ON when Carrier Operated scan is selected.
- ⑯ **DUP** ON during duplex operations.
- ⑰ **ABC** ON when the A.B.C. (Automatic Band Change) function is active.
- ⑱ **M** ON when the MAIN band frequency displays a memory channel.

⑲ **★8**

Displays the current Memory Channel number or Call channel "C" indicator. The star indicator is ON when the Memory channel will be skipped during Memory Channel Scan.

⑳ **BUSY**

ON when the MAIN squelch is open.

㉑ **B**

ON when the SUB squelch is open.

㉒ **SAVE**

ON when the BATTERY SAVER function is active.

㉓ **APO**

ON when the AUTOMATIC POWER OFF function is active.

㉔ **F**

ON whenever the F key is depressed.

㉕ **888.888.**

Displays the operating frequency of the SUB band.

Flashes when Scanning.

4-2. RECEIVER OPERATION

4-2-1. Reception

1. Turn ON the Power Switch. The display should indicate frequency. Fig. 1 shows examples of frequencies that might appear on the various models.

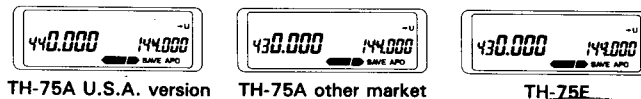

Fig. 1

2. Set the BAL control to the MAIN position.
3. Rotate the VOL control clockwise until a UHF signal or noise is heard.
4. Rotate the Tuning control to select an open channel.
5. Then rotate the U SQL control clockwise until the noise disappears and the BUSY indicator goes OFF (Threshold point).
6. Rotate the Tuning control to select the desired frequency.
7. Press the BAND key to exchange bands.
8. Rotate the Tuning control to select an open channel.
9. Then rotate the V SQL control clockwise until the noise disappears and the BUSY indicator goes OFF.
10. Rotate the Tuning control to select the desired frequency.

Dual band reception (Simultaneous reception on both bands)

11. When a signal is received, the BUSY or the B indicator will turn ON.
12. To proportion volume between the MAIN band and SUB band, rotate the BAL control to the desired point. The VOL control regulates the amount volume of two bands.

Single band reception

Press the DUAL key. The SUB band frequency display will turn off.

4-2-2. Frequency Selection

You can change the dial frequency of the MAIN band while in the VFO mode.

The frequencies can then also be stored in Memory or in the Call channel using the techniques that will be described in this manual.

To select the other band press the BAND key momentarily.

MAIN BAND

■ VFO MODE

- Direct keyboard frequency entry

1. Press the ENT key to select the ENTER mode.

ENT

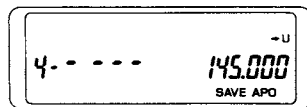

(U.S.A. version)

2. Within 10 seconds of pressing the ENT key enter the frequency to the nearest kHz.

For example

U.S.A. version:



Other version:



The receiver will not change frequency until all digits have been entered.

If you should make an error before entering all digits, press the ENT key twice, and reenter all digits.

- Tuning control frequency selection

Rotate the Tuning control to select the desired frequency.

■ MEMORY RECALL MODE

- Direct keyboard memory recall

1. Simply press the desired memory channel key and the radio will switch to the channel frequency.
2. To return to the original operating frequency, press the same memory channel key again.

- Tuning control memory recall

After the direct keyboard memory recall you can rotate the Tuning control to select the desired memory channel.

■ CALL CHANNEL MODE

1. Press the CALL key to select the CALL Channel mode. The CALL indicator and the call channel frequency are displayed on the display.
2. To return to the previous mode press the CALL key again.

■ SUB BAND

It is impossible to change the mode directly in the SUB band.

- **If the current frequency is in VFO mode:**

You can press the UP/DWN keys to select the desired frequency of the SUB band.

- **If the current frequency is in MR mode:**

You can press the UP/DWN keys to select the desired memory channel of the SUB band. (The Channel number is not displayed.)

- **Current frequency is in CALL Channel mode:**

The Call channel frequency can not be changed in the SUB band.

4-2-3. FREQUENCY STEP SELECTION

The frequency step as delivered from the factory is illustrated below:

	TH-75A	TH-75E
144 MHz Band	5 kHz	12.5 kHz
430/440 MHz Band	25 kHz	25 kHz

To select the desired tuning or scan step size use the following procedures:

MAIN BAND

1. Press the F key. The F indicator should light in the display.
2. Press the MHz/STEP key within 10 seconds of pressing the F key. The current frequency step size will be displayed.
3. Rotate the Tuning control until the desired tuning step size appears in the display.
4. To complete the programming of the step size you can press any key on the front panel, or simply wait 10 seconds and the microprocessor will automatically return to the normal frequency display.

F

STEP

MHZ

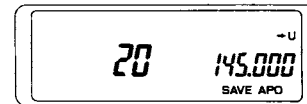

The accompanying figure shows how the Tuning control will increase or decrease the step size.

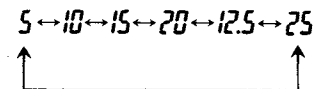

SUB BAND

It is not possible to select the Frequency Step directly while in the SUB Band. Change to the MAIN band if you want to alter the step size. Then return to the SUB band.

Downloaded by
Amateur Radio Directory

www.hamdirectory.info

4-2-4. PROGRAMMABLE VFO TUNING LIMIT

This transceiver provides the capability of programming the VFO tuning range, in 1 MHz band segments, as well as providing a separate programmable band scan function (See section 4-5). For example you could tell the transceiver that you only wish to tune the 144.000 MHz and 145.000 MHz band segments by specifying any frequency with these two segments. The tuning controls would then only tune within these specific bands.

The procedure for specifying the bands is described below.

1. Select the desired lower tuning range.

For example you might want to select the 144 MHz band, and enter 144.100 MHz.



2. Press the M key. The M indicator should light in the display.
3. Press the ∇ key within 10 seconds of pressing the M key. The M indicator will turn off. This indicates that the lower limit has been successfully stored in memory.
4. Now select the desired upper tuning limit using the MHz key or tuning control.



With our example we want the upper band limit to be in the 145 MHz band, and therefore dial up 145.100 MHz.



5. Press the M key. The M indicator should light in the display.
6. Press the Δ key within 10 seconds of pressing the M key. The M indicator will turn off. This indicates that the upper limit has been successfully stored in memory.
7. To confirm that the programming was properly performed rotate the tuning control. The transceiver should not go above or below the programmed band limits.
8. To clear both programmed limits simultaneously you should initialize the VFO memory using the following procedures.

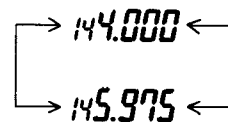

VFO RESET

- (1) Turn the Power switch off.
- (2) Press and hold the ENT key and turn on the power switch.
- (3) Release the ENT key.

You can reprogram either limit independently by following the appropriate instructions above.

4-2-5. A.B.C. (AUTOMATIC BAND CHANGE)

The A.B.C. function allows you to exchange the contents of SUB band to the MAIN band automatically whenever a signal is received in the SUB band and SUB squelch is open. Pressing the PTT switch release the A.B.C. function.

1. Press the A.B.C. key within 10 seconds of pressing the F key. The A.B.C. indicator will turn on in the display.

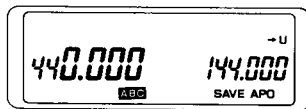
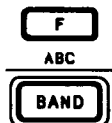

2. As soon as a signal is received in the SUB band, bands exchange occurs. The Tuning control are not effective during this exchange.

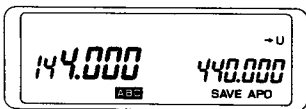

Pressing the PTT switch releases the A.B.C. function.

If the PTT switch is not pressed within 3 seconds after the signal goes off, the MAIN band will be restored to its original frequency.



4-3. TRANSMITTER OPERATION

CAUTION:

1. Ensure that an antenna with a low standing wave ratio (SWR) is attached to the antenna connector before attempting to transmit. Failure to provide proper termination may result in damage to the final amplifier section.
2. Always check to ensure the frequency is clear before transmitting.

TRANSMIT

1. Select the desired operating frequency in the MAIN band using any of the methods previously discussed.
2. Check the frequency to see if it is occupied before you transmit.
3. Press the PTT switch. The ON AIR indicator will light, and the RF meter will light.
4. Speak into the microphone. The recommended distance to the microphone is 5 cm (2 inches).

NOTE:

Talking closer may result in overdeviation of your transmit signal, which might be reported as a loss of clarity or an excessively wide transmit signal.
Talking too far away may result in reports of weak audio.

5. Release the PTT switch to return to the receive mode. The ON AIR indicator should go out, and the RF meter will return to zero.

DUPLEX OPERATION

During duplex operation pushing the PTT switch allows the simultaneous reception on the SUB band while you transmitting on the MAIN band.

NOTE:

Receiver sensitivity may be suppressed with certain combination of transmit and receive frequencies.
Use of earphone causes no howling.

4-4. MEMORY

4-4-1. MICROPROCESSOR MEMORY BACK-UP

A lithium battery is contained in the transceiver to retain memory.

Turning off the POWER switch, or a power failure will not erase the memory. The battery should last for approximately five years.

When the battery discharges, an erroneous display may appear in the display.

Lithium battery replacement should be performed by an authorized KENWOOD service facility; either your KENWOOD dealer, or the factory, since this unit contains CMOS type circuitry.

4-4-2. MICROPROCESSOR INITIALIZATION

The Initial state of the microprocessor as delivered from the factory is shown in the chart below.

	VHF BAND	UHF BAND	
		TH-75A U.S.A./Canada	TH-75A/E
VFO and Memory Channel frequency	144 MHz	440 MHz	430 MHz
Frequency step	5 kHz	25 kHz	25 kHz
Tone frequency	*(88.5 Hz)	88.5 Hz	*(88.5 Hz)

* Only when CTCSS unit is installed.

Microprocessor Initialization

When you want to erase all programed data, or if the display should show erroneous information, you should initialize (reset) the microprocessor using the following procedure.

1. Turn the POWER switch off.
2. Press and hold the M key and turn on the POWER switch.
3. Release the M key.

4-4-3. MEMORY CHANNEL

This transceiver provides 10 Memory Channels for the VHF band and another 10 Memory Channels for the UHF band. In addition to serving as a normal Memory Channel some of the Memory Channels serve a dual purpose to specify other parameters. The functions of these Memory Channels are described below.

- * Memory Channel 1 is used to store the frequency for the Priority Alert function.
- * Memory Channel 8 is used to store the lower limit for the Programable Band Scan function.
- * Memory Channel 9 is used to store the upper limit for the Programable Band Scan function.
- * Memory Channel 0, 1, and 2 are used to store odd split repeater data information.

4-4-4. MEMORY CONTENTS

Each Memory channel is capable of storing the following information.

Memory channel	Split CH		Normal CH CALL CH
	RX	TX	
Frequency data	○	○	○
Tone frequency data	○	N/A	○
CTCSS, Tone ON/OFF (except 1750 Hz)	○	N/A	○
SHIFT status	N/A		○
REVERSE ON/OFF	N/A		○

4-4-5. MEMORY ENTRY

Memory entry must be done from the MAIN band.

Simplex/Normal shift

1. Select the desired operating frequency, offset, tone frequency, etc. (For example 145.600 MHz)

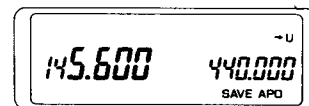

2. Press the M key. The M indicator will light.



3. Press the desired Memory Channel number using the numeric keypad. (For example CH5)
The M indicator and the Memory Channel number will turn OFF.



Odd Split Channels

1. Select the desired receive frequency, tone frequency, Tone on etc. (For example 145.600 MHz Tone on)
2. Press the M key and then Press the desired Odd Split Channel number using the numeric key. (For example CH1)



- You should, select the desired transmit frequency using the Tuning control. (For example 145.700 MHz)



- Press the M key.



- Within 10 seconds of pressing M key press and hold the PTT switch and press the same Odd Split Channel number key you pressed in step 2.

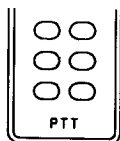

- To confirm the contents of the Odd Split Memory Channel press the Odd Split Channel key. The receiving frequency and the - + indicator will appear in the display.

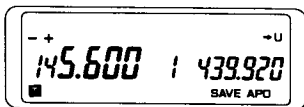

REV



- To check the transmit frequency press the F key and then REV key, or the PTT switch. The transmitting frequency will appear in the display.

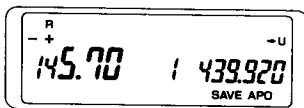

CALL CHANNEL

- Select the desired operating frequency, offset, tone frequency, etc. (For example 146.100 MHz).



- Press the M key. The M indicator will turn on.



- Press the CALL key within 10 seconds of pressing the M key to enter the data into memory. The M indicator will turn OFF to confirm data entry.

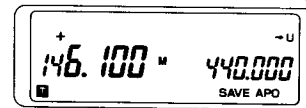

4-4-6. MEMORY CHANNEL RECALL

Please refer to Frequency Selection page 12.

4-4-7. MEMORY SHIFT

Using this function you can copy the contents of a Memory Channel or Call channel to the VFO without changing the data in memory.

This will allow you to change the tone data, or tune normally if wish.

1. In the Memory channel mode or CALL channel mode press the ENT key. The display will indicate the ENTER mode frequency status.

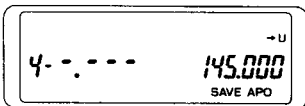
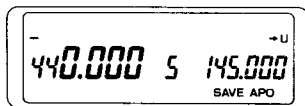

2. Within 10 seconds of pressing the ENT key, rotate the tuning control to the desired frequency. The Memory Channel or CALL Channel indicator will turn OFF to signal the data has been successfully transferred to the VFO.

NOTE: _____

1. If you do not need to change the frequency after shifting the Memory contents to the VFO simply press the ENT key twice.
2. If an Odd Split Memory channel is selected, only the receive data will be copied.

4-5. SCAN

4-5-1. SCAN OPTIONS

The following scan options are available:

Band scan

Scan proceeds over the entire main band. This function operates in the VFO mode only.

Programmable Band scan

The scan range in this mode is specified in main band memory channel 8 and 9. This function operates in the VFO mode only.

Memory Channel Scan

Scan proceeds thru those main band memory channels that have data stored and have not been locked out.

This function operates in the Memory Channel mode only.

Double Memory Scan

Scan proceeds thru all sub memory channels that have data stored and have not been locked out simultaneously with main memory channels. This function operates in the both Memory Channel modes only.

Scan will not function when the Tone Alert System is active.

4-5-2. HOLD/RESUME PROGRAMMING

Two type of scan hold/resume have been provided in this transceiver.

Time Operate scan (TO)

You may prefer that the radio stops on a busy channel and remains there approximately 5 seconds, and then continues to scan even if the signal is still present.

Carrier Operated scan (CO)

In this mode the radio will stop scanning on a busy channel and remain there until the signal drops out. The radio allows a 2 second delay before it resumes scanning so that you don't lose the station when operators change.

During CTCSS operation scan will not stop until the same tone is received.

This transceiver is delivered from the factory in the Time operated scan mode. To switch between the two modes use the following procedure.

1. Press the F key. The F indicator will light.
2. Press the 4/TO/CO key within 10 seconds of pressing the F key. This will toggle the Hold/Resume mode to Carrier operated mode. The CO indicator will light.
3. To return to Time operated mode repeat steps 1 and 2.

4-5-3. BAND SCAN

1. Adjust the SQL control to the threshold point.
2. Press the SCAN/DMS key. The MHz indicator will begin flashing to signal the transceiver is scanning.
3. Scan will begin in an upward direction. You can reverse the direction of scan by rotating the Tuning control clockwise. The tuning step size depends upon the current step selection.
4. Scan will stop whenever a signal is received that will open the squelch of the radio.
5. You can cancel scan with PTT switch and any front panel key except the Δ ∇ keys.

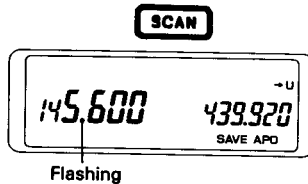

Flashing

4-5-4. PROGRAMMABLE BAND SCAN

1. The lower scan limit must be stored in Memory Channel 8.
The higher scan limit must be stored in Memory Channel 9.

CAUTION:

If the frequency and the frequency step in Memory Channel 8 is equal to or greater than the frequency and the frequency step in Memory channel 9 scan will proceed over the entire tuning range of the set, i.e. it will function like the Band Scan previously described.

2. Adjust the SQL control to the threshold point. Select a frequency between the two programmed scan limit.
3. Press the SCAN/DMS key. The MHz indicator will begin flashing to signal the transceiver is scanning.
4. Scan will begin in an upward direction. You can reverse the direction of scan by rotating the Tuning control clockwise. The tuning step size depends upon the current step selection.
5. Scan will stop whenever a signal is received that will open the squelch of the radio.
6. You can cancel scan with PTT switch and any front panel key except the Δ ∇ keys.

4-5-5. MEMORY CHANNEL SCAN

1. Adjust the SQL control to the threshold point.
2. Press any numeric key to select Memory Channel mode.
3. Press the SCAN/DMS key the MHz indicator will begin flashing and the memory channel indicator will indicate the memory channels that are being scanning.
4. Scan will begin at the current memory channel and proceed upwards thru the memory channels. You can reverse the direction of scan by rotating the Tuning control clockwise. Only those memory channels that have data entered into it will be scanned.
5. Scan will stop whenever a signal is received that will open the squelch of the radio.
6. You can cancel scan with the PTT switch or any front panel key except the Δ ∇ keys.

4-5-6. DOUBLE MEMORY SCAN

1. Adjust the SQL control to the threshold point.
2. Press any numeric key to select the Memory Channel mode. Press the BAND key to exchange the band.
3. Press any numeric key to select the Memory Channel mode of the main band.
4. Press DUAL/DUP key to select dual band operation.

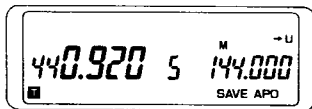

DUAL

5. Press the F key. The F indicator will light.
6. Press the SCAN/DMS (Double Memory Scan) key within 10 seconds of pressing the F key. Scan will begin at each current memory channel and proceed upwards thru each memory channels.

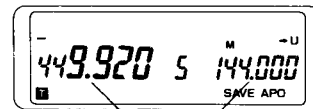
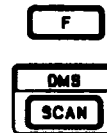

Flashes

- You can reverse the direction of scan by rotating the Tuning control counterclockwise. Only those memory channels that have data entered into it will be scanned.
7. Scan will stop whenever a signal is received that will open the squelch of the radio.
 8. You can cancel scan with PTT switch and any front panel key except the Δ ∇ keys.

4-5-7. MEMORY CHANNEL LOCKOUT

This function allows you to specify which memory channels you wish to scan during Memory Channel scan.

1. Select the Memory Channel that you wish to skip by pressing the numeric key.
2. Press the F key. The F indicator will light.

5

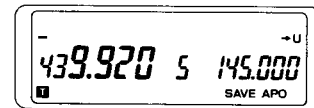

F

3. Press the O/L.OUT key within 10 seconds of pressing the F key.

A star ★ will appear to the left of the Memory Channel number. This indicates the Memory Channel will be skipped during the Memory Channel scan mode.

4. Repeat steps 1, 2 and 3 to lock out any other Channels you wish to skip.

5. To cancel the lockout, select the desired Memory Channel as described in steps 1, 2 and 3 above. A star should appear to the left of the Memory Channel number. Press the F key. The F indicator will light. Press the O/L.OUT key within 10 seconds of pressing the F key. The star indicator should turn off.

L. OUT

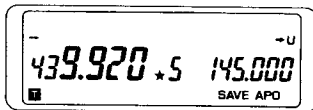

3. Press the F key. The F indicator will light.



AL



4. Press the 1/AL key within 10 seconds of pressing the F key.

The AL indicator will turn on in the display to remind you that this function has been activated. If a signal is present a beep will be heard from the speaker.

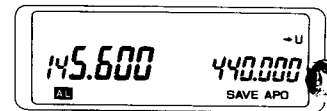

NOTE:

During the period memory channel 1 is being scanned you will not hear voice communications on the priority channel, only the beep will be heard if a signal is present.

4-5-8. PRIORITY ALERT

The priority alert function allows you to monitor memory channel 1, once every 5 seconds for activity, even when you are tuned to a different channel.

To activate the priority alert function:

1. Enter the frequency you wish to monitor into memory channel 1.



2. Adjust the SQL control to the threshold point.



4-6. REPEATER OPERATION

4-6-1. TRANSMITTER OFFSETS

All amateur radio repeaters utilize a separate receive and transmit frequency. The receiver frequency may be either above or below that of the transmit frequency. The configuration of most repeater will fall into one of the categories listed below:

Band	144 MHz	430/440 MHz	
Model	TH-75A TH-75E	TH-75A	TH-75E
Display			
+	+ 600 kHz	+ 5 MHz	+ 1.6 MHz
-	- 600 kHz	- 5 MHz	- 1.6 MHz
- 			- 7.6 MHz

● OFFSET DIRECTION

To select the desired transmitter offset direction press the SHIFT/REV key. Each time you press these key the transceiver will advance from one direction to the other, i.e. + to - (- to -  with European version) to no offset (simplex).

● AUTO-OFFSET (U.S.A. and Canada ONLY)

The TH-75A has been programmed according to the standard APRL Band Plan with regard to transmitter offsets direction. Please see the accompanying chart for additional information on this programming. You can, of course, override this by using the SHIFT function, if desired.

145.1 145.5 146.0 146.4 146.6 147.0 147.4 147.6 148.0

S	-	S	+	S	-	+	S	-	S
---	---	---	---	---	---	---	---	---	---

S: simplex

4-6-2. REVERSE FUNCTION

Some repeaters utilize a "Reverse pair", i.e. the transmit/receive frequencies are exactly the reverse of another repeater.

For example repeater A uses 146.000 for a transmit frequency (INPUT) and 146.600 for a receiver frequency (OUTPUT).

Repeater B might uses 146.600 for a transmit frequency and 146.000 for receive frequency. It would be inconvenient to have to reprogram the transceiver each time if you want to use these repeaters.

The REV key allows you to easily reverse the transmit and receive frequencies.

To use the REVERSE function press the F key and then the SHIFT/REV key. The R indicator will turn on in the display to remind you that you are working a reverse pair.

To return to normal press the F key and then the SHIFT/REV key again. The R indicator will turn off.

This function is also useful to check the input frequency of the repeater, so that you can determine if you are within range for SIMPLEX communications.

4-6-3. TONE and CTCSS OPERATION

Some repeaters require the use of a control signal to activate the repeater. Several different methods are currently in use.

In the United States sub-audible tones are sometimes used. 37 different sub-audible frequencies are possible.

Tone decoder unit (same as optional CTCSS unit TSU-6) is included with U.S.A. model.

When the CTCSS function has been activated the radio will not open squelch until the proper PL tone is received.

In Europe and the United Kingdom a 1750 Hz tone is used in transmit. Press the TONE/T.SEL key to transmit with the access tone, then press the PTT switch.
A 1750 Hz tone encoder is included with all modelos.

Tone Activation

To activate the TONE function depress the TONE/T.SEL key. The T indicator will appear in the display to signify the tone has been activated.
To turn the tone OFF press the TONE/T.SEL key again.

NOTE:

37 sub-audible tones are included with U.S.A. and CANADA model.
A 1750 Hz tone encoder are included with all models.

Tone frequency selection

1. Press the F key. The F indicator will light.
2. Press the TONE/T.SEL key within 10 seconds of pressing the F key. The current tone frequency will be displayed.
3. Rotate the Tuning control until the desired tone frequency appears in the display.
4. To return to the normal frequency display, press the ENT key.

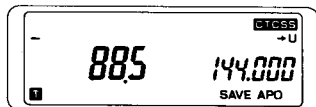

67.0 Hz	110.9 Hz	173.8 Hz
71.9 Hz	114.8 Hz	179.9 Hz
74.4 Hz	118.8 Hz	186.2 Hz
77.0 Hz	123.0 Hz	192.8 Hz
79.7 Hz	127.3 Hz	203.5 Hz
82.5 Hz	131.8 Hz	210.7 Hz
85.4 Hz	136.5 Hz	218.1 Hz
88.5 Hz	141.3 Hz	225.7 Hz
91.5 Hz	146.2 Hz	233.6 Hz
94.8 Hz	151.4 Hz	241.8 Hz
100.0 Hz	156.7 Hz	250.3 Hz
103.5 Hz	162.2 Hz	
107.2 Hz	167.9 Hz	(1750 Hz)

Note: 1750 Hz is available only for encode.

CTCSS Activation

When the CTCSS indicator appears in the display the transceiver will operate in the TONE squelch mode, i.e. Squelch will not open until the same tone is received as a portion of the incoming receive signal.

DUAL BAND OPERATION

1. Press the F key. The F indicator will light.
2. Press the 6/CT.V/U key within 10 seconds of pressing the F key. Alternately the V or U indicator will light. Select the band that you want for tone squelch operation.

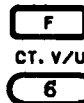

3. Press the F key and then press the 3/CTCSS key. The CTCSS indicator will be displayed.
4. To turn off the CTCSS function, press the F key and then the 3/CTCSS key again.

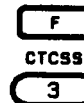

Downloaded by
Amateur Radio Directory

www.hamdirectory.info

SINGLE BAND OPERATION

1. Press the F key. The F indicator will light.
2. Press the 3/CTCSS key within 10 seconds of pressing the F key. The CTCSS indicator will light.
3. To turn off the CTCSS function, press the F key and then the 3/CTCSS key again.

F

CTCSS

3



4-6-4. AUTOPATCH (U.S.A. version only)

Some repeaters offer a service known as autopatch. This feature allows you to dial a telephone number from your transceiver and carry out a telephone conversation, much like a car telephone, or cellular telephone. This function requires the use of a DTMF (Dual Tone Multi Frequency) pad. In addition to the normal 12 keys that are found on your telephone the transceiver also provides 4 additional keys, A, B, C, and D. These keys are used for control purpose on some repeater systems. You should check with the control operator of the repeater to see if they offer autopatch services. A chart is provided that lists the various tones frequencies that are generated by the keypad.

To activate the keypad:

1. Press and hold the PTT switch.
2. Press the keys just like you would dial your telephone at home.

Column Row	1209	1336	1477	1633
679	1	2	3	▽/A
770	4	5	6	M/B
852	7	8	9	ENT/C
941	★	0	#	SCAN/D

NOTE:

Some repeaters will require the use of a special key sequence to activate the Autopatch function. You should check with your control operator for this sequence.

4-7. TONE ALERT SYSTEM

The Tone Alert function will provide an audible "alarm" to signal when someone is transmitting on the frequency you are monitoring on both bands.



1. Adjust each SQL control to the threshold point.
2. If you will be using the TSU-6 for CTCSS decode you should select the desired tone frequency and then press the F key and CTCSS key. Please refer to page 24.
3. Press the F key and then the 2/T.ALT key. T.ALT indicator will light.
4. When a signal is present: The T.ALT indicator will flash. The busy indicator will light. The transceiver will beep ON and OFF for approximately 5 seconds.



U and V SQL



flashes



NOTE:

Whenever a signal in the SUB band is received the contents of SUB band exchange to the MAIN band automatically.

When using CTCSS the incoming signal must be present for approximately 1 second in order for the T.ALT to function properly.

5. The T.ALT function can be released by pressing the F key and 2/T.ALT key again, or pressing the PTT switch while the T.ALT indicator is flashing.

NOTE:

The tuning control, PTT switch and all the keys except MONI, LAMP, and F are not effective during the T.ALT operations.

During the T.ALT operations the Automatic Band Change and Automatic Power Off function are disabled.

4-8. BATTERY SAVER

The transceiver provides a battery saver mode to conserve on battery power.

1. Press the F key and then the 7/SAVE key. SAVE indicator will light.
The transceiver will activate the battery saver circuit 10 seconds after the last key operation with the squelch closed.
2. The function will be released by key operation or when squelch opens.
3. The function can be released by pressing the F key and 7/SAVE key again.

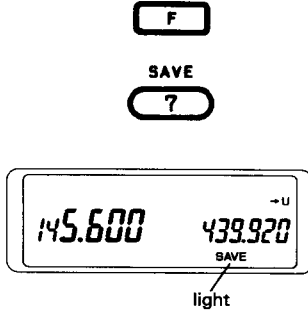

NOTE: _____
The function can not be activated during scan or Tone Alert system operation.
It is possible that you might press the MONI switch during the OFF period.

4-9. AUTOMATIC POWER OFF

The transceiver also provides an Automatic Power OFF circuit. The circuit action is described below.

1. Press the F key and then the 8/APO key. APO indicator will light.
2. A 5 second audio confirmation alert will sound after 59 minutes if no signal has been received and if you have not performed any operation.
3. 1 minute after this alert signal the transceiver will shut itself off except for enough power to show "APO" in the display.
4. When the APO operates and the transceiver is shut off after 60 minutes, the transceiver can be reactivated by pressing the MONI switch, or by turning the power switch OFF and back ON.
5. The APO mode can be cancelled by pressing the F key and then the 8/APO key.

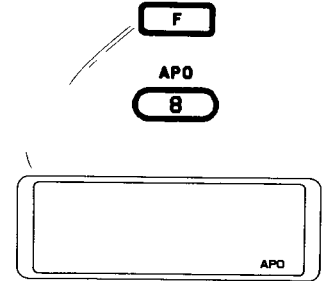

NOTE: _____
The function can not be activated during scan or Tone Alert system operation.
To conserve battery life even more simply turn the transceiver OFF when you are not using it.

4-10. FAST SQUELCH

Normal squelch operation might react too slowly for reliable packet or other high speed data formats.

This is because portions of the receiver are biased off, to reduce the power consumption, and require a short delay before they can switch back on.

This FAST SQUELCH function allow a more rapid response to incoming signals during squelch operation.

1. Turn the POWER switch off.
2. Press and hold the F key and turn on the POWER switch. The fast squelch indicator will turn on.
3. Release the F key.
4. To turn this function off repeat step 1,2 and 3.

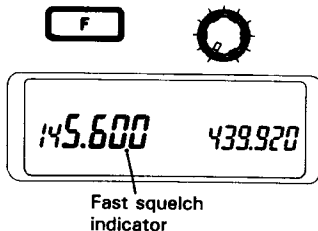

NOTE: Do not activate Battery Saver function for the FAST SQUELCH to function properly.

6. MAINTENANCE

6-1. GENERAL INFORMATION

Your transceiver has been factory aligned and tested to specification before shipment. Under normal circumstances the transceiver will operate in accordance with these instruction manuals. All adjustable trimmers and coils in your transceiver has been adjusted at the factory and should only be readjusted by a qualified technician with proper test equipment. Attempting service or alignment without factory authorization can void the transceiver's warranty.

When operated properly, the transceiver will provide many years of service without requiring realignment. The information in this section gives some general service procedures which can be accomplished without sophisticated test equipment.

6-2. SERVICE

Should it ever become necessary to return the equipment to your dealer or service center for repair, pack it in its original box and packing, and include a full description of the problems involved. Also include your telephone number. You need not return accessory items unless directly related to the service problem.

SERVICE NOTE: _____

Dear OM, if you desire to correspond on a technical or operational problem, please make your note short, complete, and to the point, and PLEASE make it readable.

Please list: Model and Serial Number

The problem you are having.

Please give sufficient detail to diagnose. Information such as other equipment in the station, meter readings and anything else you feel might be useful in attempting diagnosis.

CAUTION: _____

Do not pack the equipment in crushed newspapers for shipment. Extensive damage may result during shipment.

NOTES: _____

1. Record the Date of Purchase, Serial Number and Dealer from whom purchased.
2. For your own information, retain a written record of any maintenance performed on the unit.
3. When claiming warranty service, a photocopy of the bill of sale, or other proof of purchase showing the date of sale must accompany the radio.

Downloaded by
Amateur Radio Directory

www.hamdirectory.info

6-3. IN CASE OF DIFFICULTY

The problems described in this table are failures caused, in general, by improper operation or connection of the transceiver, not by defective components. Examine and check according to the following table.

Symptom	Probable cause	Corrective action
Indicators do not light and data is not displayed when power switch is turned on.	<ol style="list-style-type: none"> 1. Low voltage. 2. With optional DC cable: <ol style="list-style-type: none"> a. Wrong power polarity. b. Fuse is blown. 	<ol style="list-style-type: none"> 1. Recharge/replace the battery. 2. <ol style="list-style-type: none"> a. Connect red to + and black to - . b. Replace with the specified fuse.
All the indicators go out on the LCD display. All the indicators flash.	<ol style="list-style-type: none"> a. Low voltage 	<ol style="list-style-type: none"> a. Recharge/replace the battery.
No sound from the speaker. No signal can be received.	<ol style="list-style-type: none"> 1. Squelch is closed. 2. In the wrong position BALANCE control position. 3. CTCSS is operating (when CTCSS unit had been installed). 	<ol style="list-style-type: none"> 1. Turn the SQL controls counterclockwise. 2. Readjust the BALANCE control. 3. Press the F key and then 3/CTCSS key to turn off the CTCSS.
Weak signal cannot be received.	<ol style="list-style-type: none"> 1. Poor antenna connection. 	<ol style="list-style-type: none"> 1. Connect antenna securely.
No control works.	<ol style="list-style-type: none"> 1. K.LOCK or LOCK is ON. 2. During A.B.C. operation, being exchanging the bands each other. 	<ol style="list-style-type: none"> 1. Press the F key and then the K.LOCK or Lock key to cancel the LOCK function. 2. See A.B.C. Page 15.
Memory cannot be backed up.	Backup battery voltage is low.	See Microprocessor memory back-up page 16.

Heterodyne tones may occur happen in the simultaneous reception on both bands.
This is not due to defective components.

7. OPTIONAL ACCESSORIES

7-1. CTCSS unit TSU-6

The use of the optional sub-audible tone decoder TSU-6 allows for CTCSS (Tone squelch) operations. (The TSU-6 is included with U.S.A. and CANADA models.) When this option is activated squelch will only open when the proper sub-audible tone is received.

7-1-1. Installation

Before installation, be sure to turn the power switch OFF, or damage may result to the transceiver or the tone unit.

1. Remove the backing from the cushion that was provided the TSU-6 and attach it to the back of the TSU-6 as shown in the Fig. 2.
2. Remove the Battery Pack and remove the two phillips head screws from the terminal plate of the transceiver (Fig. 1).
3. Remove the 3 screws securing the front panel.
4. Remove the rubber cap from the DC IN terminal on the side of the transceiver (Fig. 1).
5. Gently remove the front panel. Be sure not to disconnect the wire to speaker (Fig. 2).
6. Remove the clear tube covering the connector, and the wire inserted.
7. Cut the resister shown in the Fig. 3.
8. Attach the cable from TSU-6 (Fig. 2).
9. Remove the backing from the other side of the cushion and attach the TSU-6 to the transceiver.
10. Replace the front panel and tighten the screws to complete the installation. Do not pinch the rubber cap or the wiring when closing the front panel.

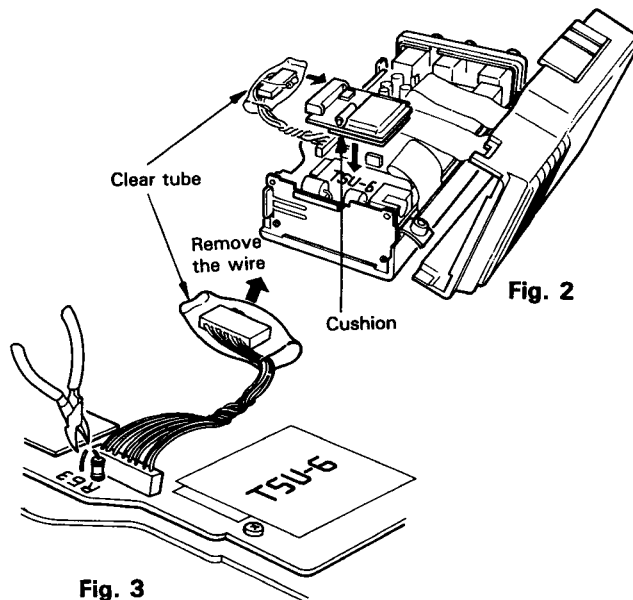
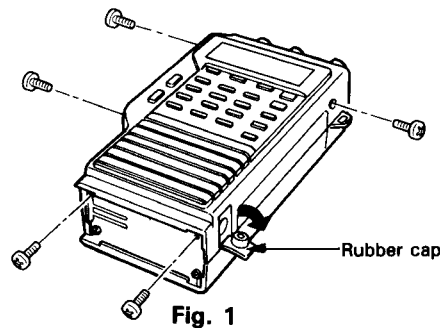

MICRO HEADPHONES HS-7



MICRO HEADPHONE HS-8



TELESCOPIC ANTENNA RA-3 (144 MHz)



CTCSS UNIT TSU-6

SPEAKER MICROPHONE SMC-32



SPEAKER MICROPHONE SMC-31



WATER RESISTANT BAG WR-1



HEADSET WITH VOX/PTT HMC-2



SOFT CASE SC-22 (for PB-5/6, BT-6)



SOFT CASE SC-23 (for PB-7/8/9)



NiCd BATTERY PACK PB-5 7.2V, 200mAh H: 36.5mm, 80g



NiCd BATTERY PACK PB-6 7.2V, 600mAh H: 55.5mm, 165g



NiCd BATTERY PACK PB-7 7.2V, 1100mAh H: 98.5mm, 290g



NiCd BATTERY PACK PB-8 12V, 600mAh H: 84mm, 250g



NiCd BATTERY PACK with BUILT-IN CHARGER PB-9 7.2V, 600mAh H: 98.5mm, 250g (for U.S.A. version)



WALL CHARGER (supplied) BC-9 (for PB-6/7 only)



COMPACT CHARGER BC-10



RAPID CHARGER BC-11



(Hours)

RECHARGING TIME	PB-5	PB-6	PB-7	PB-8	PB-9
BC-9	N/A	15	30	N/A	N/A
BC-10	8	8	15	8	8
BC-11	1	1	1	1	1

DC POWER CABLE PG-2V

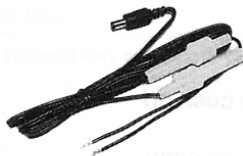

FILTERED CIGARETTE LIGHTER CORD PG-3E



BATTERY CASE BT-6



Downloaded by
 Amateur Radio Directory

www.hamdirectory.info

NOTE: Some optional accessories may not be available in your area.