

ONKYO® SERVICE MANUAL

Integrated Stereo Amplifier MODEL A-8057

Silver and Black models

UDN, UD	120V AC, 60Hz
UG	220V AC, 50Hz
UW	120V or 220V AC, 50/60Hz

SAFETY-RELATED COMPONENT WARNING!!

COMPONENTS IDENTIFIED BY MARK  ON THE SCHEMATIC DIAGRAM AND IN THE PARTS LIST ARE CRITICAL FOR RISK OF FIRE AND ELECTRIC SHOCK. REPLACE THESE COMPONENTS WITH ONKYO PARTS WHOSE PARTS NUMBERS APPEAR AS SHOWN IN THIS MANUAL.

MAKE LEAKAGE-CURRENT OR RESISTANCE MEASUREMENTS TO DETERMINE THAT EXPOSED PARTS ARE ACCEPTABLY INSULATED FROM THE SUPPLY CIRCUIT BEFORE RETURNING THE APPLIANCE TO THE CUSTOMER.

TABLE OF CONTENTS

Item	Page
Specifications	2
Block diagram	2
Precautions	4
Main amplifier adjustment	4
Front panel facilities	5
System connections	5
Exploded view	6
Parts list	7
Printed circuit board parts list	8
Packing procedures	10
Printed circuit board view	11
Schematic diagram	13, 17



SCHEMATIC DIAGRAM

(120V Model, 120V/220V Model)

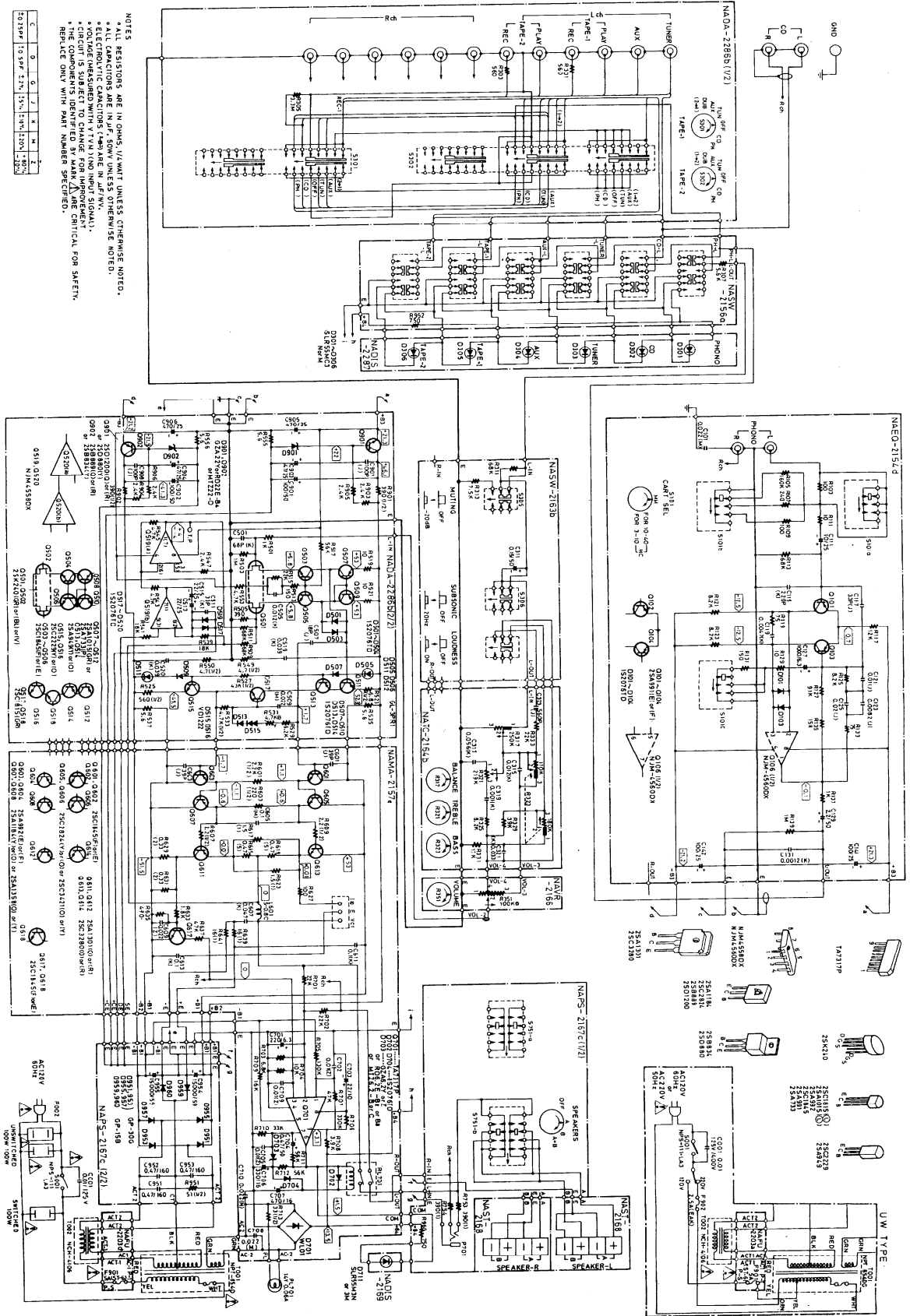

NOTES:
 * ALL CAPACITORS ARE IN P.F. UNLESS OTHERWISE NOTED.
 * ELECTROLYTIC CAPACITORS (E) ARE IN P.F. UNLESS OTHERWISE NOTED.
 * RESISTORS ARE IN OHMS, UNLESS OTHERWISE NOTED.
 * THE COMPONENTS IDENTIFIED BY MARK Δ ARE CRITICAL FOR SAFETY.
 * REPLICATE ONLY WITH PART NUMBER SPECIFIED.

SPECIFICATIONS

Power Output: 65 watts per channel, min. RMS, at 8 ohms, both channels driven, from 20 Hz to 20 kHz, with no more than 0.018% THD.

Total Harmonic Distortion: 0.018% at rated power

IM Distortion: 0.005% at rated power

Damping Factor: 50 at 8 ohms

Frequency Response: 2 – 50,000 Hz ± 1 dB

RIAA Deviation (MM): 20 – 20,000 Hz ± 0.5 dB

Sensitivity and Impedance:
 Phono(MM): 2.5 mV/50 kohms
 Phono(MC): 160 μV/100/220 ohms
 Tuner: 150 mV/50 kohms
 Tape Play: 150 mV/50 kohms
 Tape Rec: 150 mV/1.5 kohms (phono)

Phono Overload: 200 mV RMS at 1 kHz, 0.018% THD

Bass Control: ±8 dB at 70 Hz
Treble Control: ±8 dB at 20,000 Hz

Signal to Noise Ratio: Phono(MM): 80 dB (IHF A-202, 5 mV input, 1 watt output)

Phono(MC): 70 dB (IHF A-202, 0.5 mV input, 1 watt output)

Tuner & Tape: 84 dB (IHF A-202, 0.5 V input, 1 watt output)

Muting: –20 dB
Loudness Control: +6 dB at 70 Hz, +5 dB at 20 k Hz
Subsonic Filter: 15 Hz (6 dB/Octave)
High Cut (TREBLE MIN): 6 kHz (6 dB/Octave)

General

Power Supply: AC120 V, 60 Hz (D model)
 AC220 V, 50 Hz (G model)
 AC120 V or 220 V, 50/60 Hz (W model)

Semiconductors: IC: 4 TR: 38 Diode: 43
Dimensions: 435(W) × 144(H) × 391(D)mm
 17-1/8" × 5-5/8" × 15-3/8"

Weight: 10.5 kg. (23.2 lbs.)

Specifications and features are subject to change without notice.

BLOCK DIAGRAM

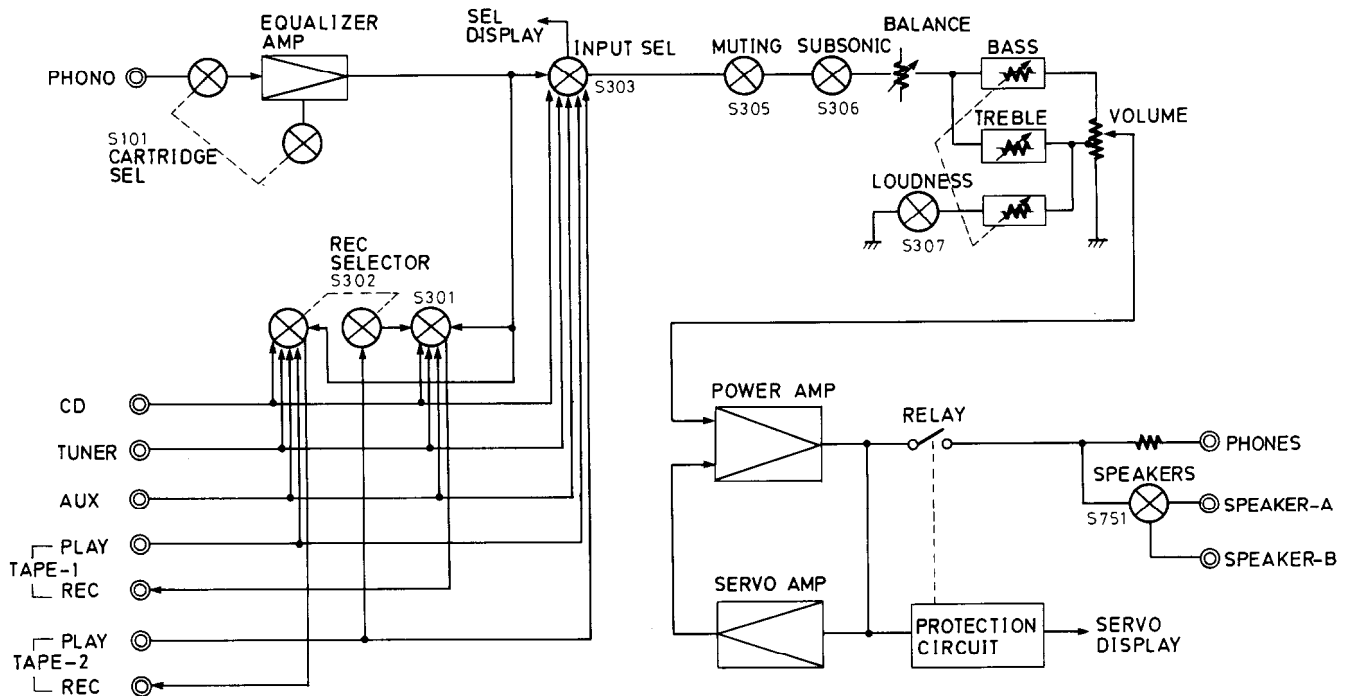

PRECAUTIONS

1. Replacing the fuses

For continued protection against risk fire, replace only with same type and same rating fuse.

CIRCUIT NO.	PARTS NO.	DESCRIPTION
F901	252050	54(ST-6), Primary fuse (120 V model)
F901	252075	2.5A-SE-EAK, Primary fuse (220 V model)
F902	252075	2.5A-SE-EAK, Primary fuse (120 V/220 V model)
F701	252070	1A-SE-EAK, Secondary fuse (220 V model)

2. Replacing the lamp

This unit uses the lamp listed below.

CIRCUIT NO.	PARTS NO.	DESCRIPTION
PL701	210183	PL14V0.06AW-2.0

3. Insulation resistance measurement (Only U.S.A model)

Connect the insulating-resistance tester between the plug of power supply cable and the terminal GND on the back panel.

Specification; 500V more than 10 M Ω

4. Voltage selector (rear panel)

Worldwide models are equipped with a voltage selector to conform with local power supplies. Be sure to set this switch to match the voltage of the power supply in your area before turning the power switch on. Voltage is changed by sliding the groove in the switch with a screwdriver or similar instrument to the up or down position. Confirm that the switch has been moved all the way to the up or down before turning the power switch on. If there is no voltage selector switch on the unit you have purchased, it can only be used in areas where the power supply voltage is the same as that of the unit.

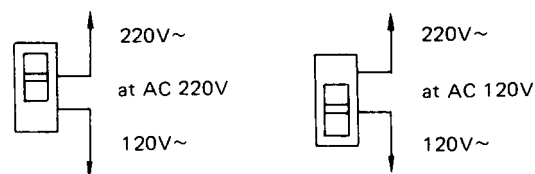

MAIN AMPLIFIER ADJUSTMENT

MAIN AMPLIFIER ADJUSTMENT

Set the all control knobs to standard position

Standard knob position

INPUT SELECTOR	CD
CARTRIDGE SELECTOR	MM
REC. SELECTOR	OFF
MODE	STEREO
MUTING	OFF
SUBSONIC FILTER	OFF
BALANCE	Center
VOLUME	Minimum
LOUDNESS	OFF
BASS	DEFEAT
TREBLE	DEFEAT
SPEAKERS	A

IDLING CURRENT ADJUSTMENT

1. Connect the DC voltmeter between I_{ID} and V_{CT} terminals.
2. Adjust the voltage to 12 \pm 5mV with semi-fixed resistor of R531 and R532.

NOTES: Adjust after switching on for 5 minutes.

VOLUME Minimum
LOAD. Open

FRONT PANEL FACILITIES

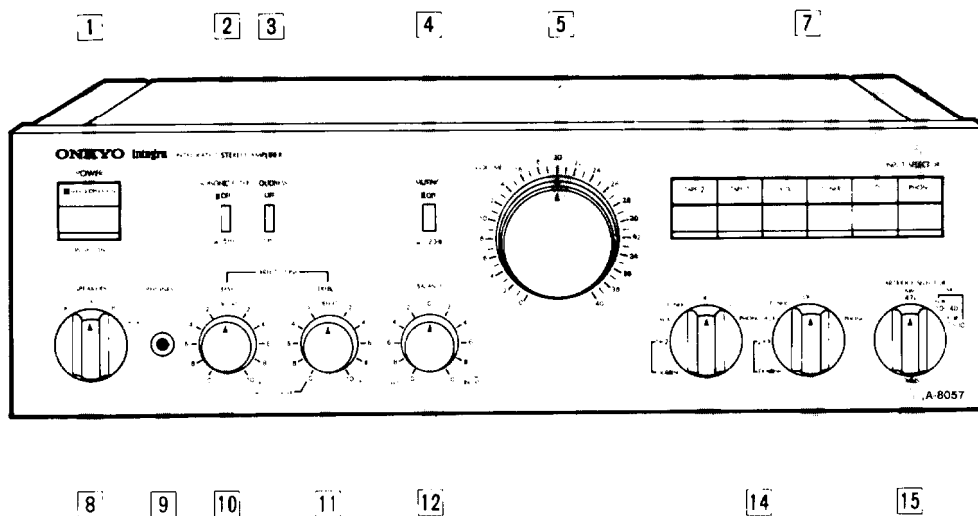

1. Power switch (POWER)
2. Subsonic filter (SUBSONIC FILTER)
3. Loudness control (LOUDNESS)
4. Muting switch (MUTING)
5. Volume control (VOLUME)
7. Input selector switches (INPUT SELECTOR)
8. Speaker selector (SPEAKERS)
9. Headphones jack (PHONES)
10. Bass control (BASS)
11. Treble control (TREBLE)
12. Balance control (BALANCE)
14. Recording source selectors (REC. SELECTOR)
15. Cartridge selector (CARTRIDGE SELECTOR)

SYSTEM CONNECTIONS

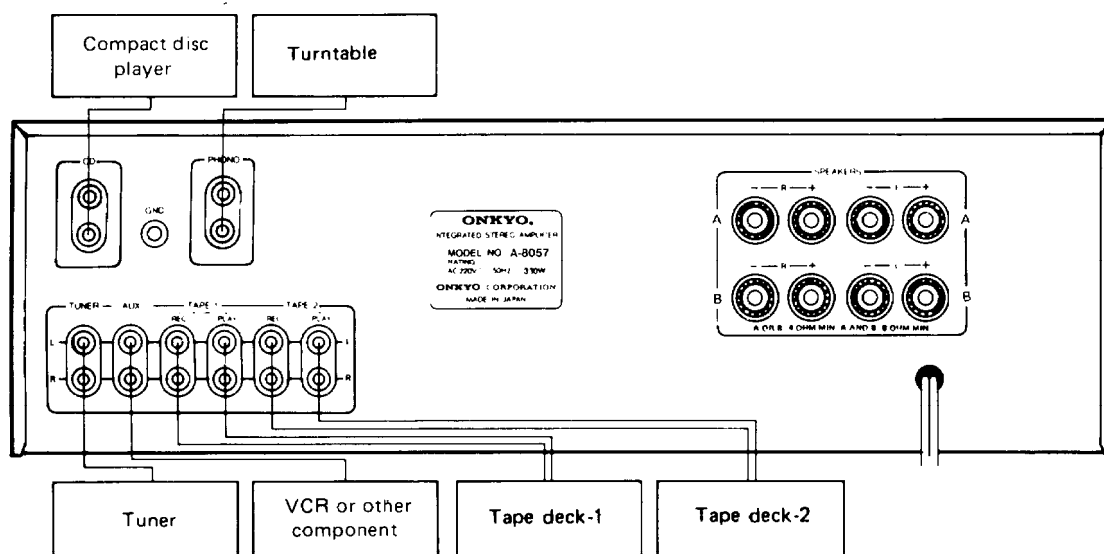

CHASSIS-EXPLODED VIEW

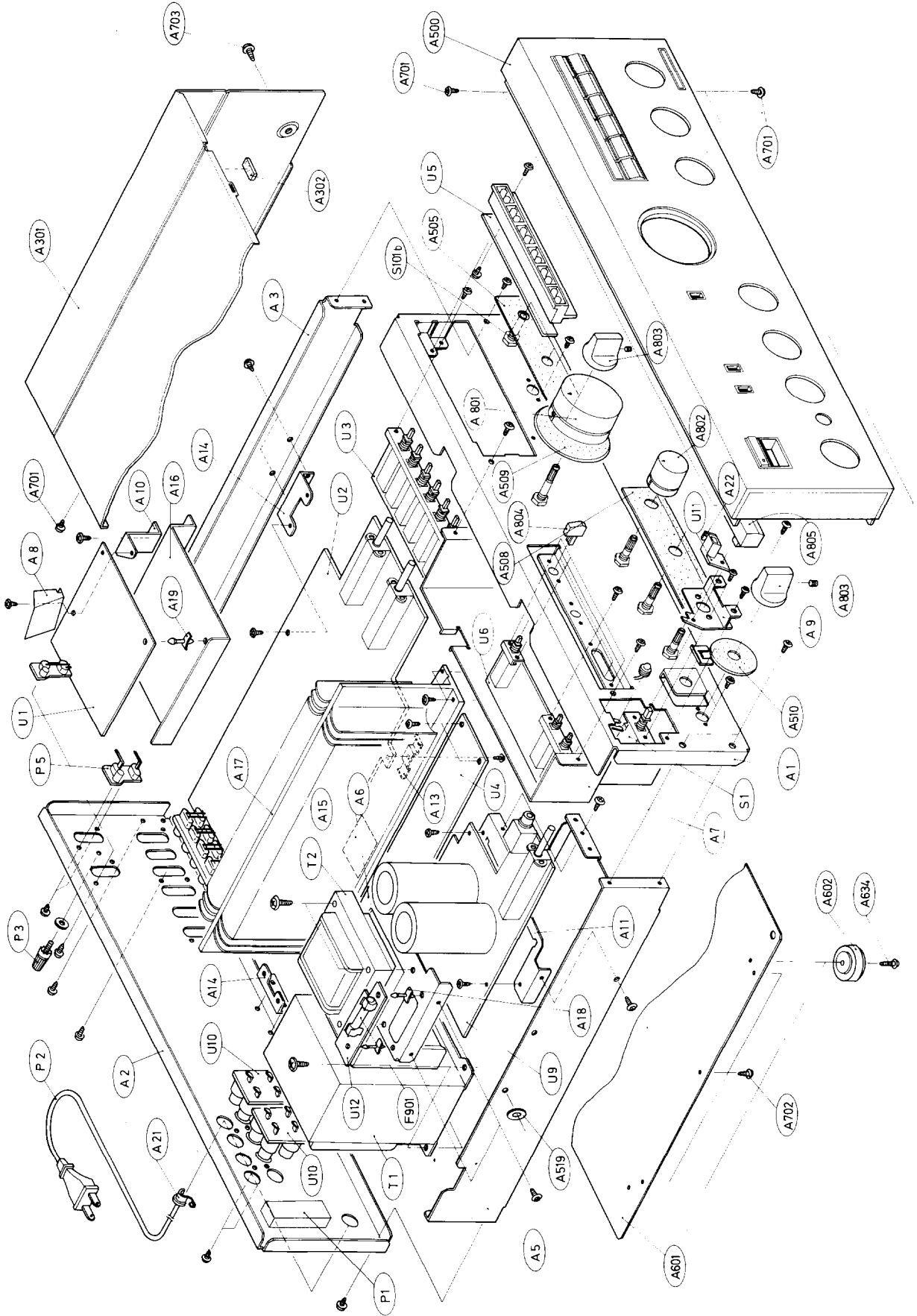

CHASSIS-EXPLODED VIEW-PARTS LIST

REF. NO.	PART NO.	DESCRIPTION	REF. NO.	PART NO.	DESCRIPTION	REF. NO.	PART NO.	DESCRIPTION
A1	27110227C	Front bracket		28321905B	Kbob (POW), [BLACK]		17994586C	NADA-2286c, Power amplifier pc board ass'y 1 [G] [Q]
A2	27120690A	Back panel [D]	Q611,Q612	2201363 or 2201362	2SA1301(O) or 2SA1301(R), Transistors	U3	12028556A	NASW-2156a, Input selector switch pc board ass'y [D] [W]
A3	27120693A	Back panel [G]	Q613,Q614	2201373 or 2201372	2SC3280(O) or 2SA3280(R), Transistors		12034556B	NASW-2156b, Input selector switch pc board ass'y [G] [Q]
A5	27115132C	Side bracket (R)		230876	NPT-854D, Power transformer [D]	U4	17988557E	NAMA-2157e, Power amplifier pc board ass'y 2 [D] [W]
A6	27130371B	Bracket (L)	△T1				17994557F	NAMA-2157f, Power amplifier pc board ass'y 2 [G] [Q]
A7	27130386	Bracket (TP)		230877A	NPT-854G, Power transformer [G]		12028587	NADIS-2287, LED pc board ass'y NASW-2163b, Muting switch pc board ass'y
A8	27130370	Bracket, shield		230878	NPT-854DG, Power transformer [W]	U5	12028587	NADIS-2287, LED pc board ass'y
A9	27130392	Shield plate (EQ)		2300013	NPT-854Q, Power transformer [Q]	U6	17988563B	NASW-2163b, Muting switch pc board ass'y
A10	27140944B	Bracket (POW)		231061	NCH-4106, Choke coil	U7	12028564B	NATC-2164b, Tone controle pc board ass'y
A11	27140945	Bracket (PC)		25035015A	NPS-111LA3, Power switch	U8	12913566	NAVR-2166, Volume controle pc board ass'y
A13	27140948	Bracket (TR)		25065123	NSS-1258P, Slide switch [W]		17988567C	NAPS-2167c, Speaker switch & Power supply pc board ass'y
A14	27140693	Bracket (BP)	△T2	3500065A	0.01µF, AC400V, Capacitor	U9	12913568	NAST-2168, Speaker terminal pc board ass'y [D] [W]
A15	28175105	Insulator plate (H)	△S1	25030262	NRSM-103-30BU, Cartridge selector, operation section	U10	12034568A	NAST-2168a, Speaker terminal pc board ass'y [G] [Q]
A16	27150168A	Shield plate (B)	△S2	25050139	NSCT-6P38, AC outlet [D]	U11	12913569	NADIS-2169, LED pc board ass'y
A17	27160154	Radiator	△C1	25108010	LG-2C, Terminal [G] [Q] [W]	U12	17988503D	NAFU-2203d, Fuse pc board ass'y [D]
A18	27190349	Holder (PC)	SI01b	253112	AS-UC-4 #18, Power supply cable [D]		17994503E	NAFU-2203e, Fuse pc board ass'y [G] [Q]
A19	27190011	LCBS-8NS, holder	△P1	253127	AS-CEE, Power supply cable [G]		17990503H	NAFU-2203h, Fuse pc board ass'y [W]
A21	27300750	Strainrelief		253092-1	AS-CEE-2, Power supply cable [W]			
A22	28140457	Cushion	△P2	728320 or 728328	2-0.75BS16 BLK or 2-0.75BS16 GRY, Power supply cable [Q]			
A301	28184269	Top cover		29380054	BS-2, AC cable tag [Q]			
A302	28184270	Top cover [BLACK]		25060044	Ground terminal			
A500	28140020	4 x 10 x 40, Cushion		25045086	NPJ-2PRBL43, Input terminal			
A501	17988121	Front panel ass'y		25050211	H0445, Fuse holder [W]			
A505	28140205A	Front panel ass'y [BLACK]		252050	5A ST-6, Primary fuse [D], [W]			
A508	28140532A	Cushion [Black]		252075	2.5 A-SE-EAK, Primary fuse [G]			
A509	28140206B	Cushion [Black]	P3	252075	2.5 A-SE-EAK, Primary fuse [W]			
A510	28140185	Cushion [Black]	P5	252070	1A-SE-EAK, Secondary fuse [G]			
A519	27175011C	Cushion [Black]	P7					
A601	27170199	Bottom board	△F901	17988554D	NAEQ-2154d, Equalizer amplifier pc board ass'y [D] [W]			
A602	27175044	Leg		17994554E	NAEQ-2154e, Equalizer amplifier pc board ass'y [G] [Q]			
A634	834430168	3TTS+16B(BC), Tapping screw	△F902	17988586B	NADA-2286b, Power amplifier pc board ass'y 1 [D] [W]			
A701	834430068	3TTS+6B(BC), Tapping screw	F701					
A702	831430088	3TTW+8B(BC), Tapping screw	U1					
A703	838440089	4TTB+8C(BC), Tapping screw						
A801	28321731A	Knob (VOL)						
A802	28321906	Knob (VOL), [BLACK]						
A803	28321723	Knob (BAL)						
A804	28322011	Knob (BAL), [BLACK]						
A805	28321726A	Knob (SP)						
	28322010	Knob (SP), [BLACK]						
	28322023	Knob (PUSH)						
	28321909	Knob (PUSH), [BLACK]	U2					
	28321904	Knob (POW)						

NOTE: [D] : Only 120V model
[G] : Only 220V model
[Q] : Only 240V model
[W] : Only 120V/220V model
[BLACK] : Only Black model

NOTE: THE COMPONENTS IDENTIFIED BY MARK △
ARE CRITICAL FOR RISK OF FIRE AND
ELECTRIC SHOCK. REPLACE ONLY WITH
PARTS NUMBER SPECIFIED.

PRINTED CIRCUIT BOARD PARTS LIST

EQUALIZER AMPLIFIER PC BOARD (NAEQ-2154d/e) PARTS LIST

CIRCUIT NO.	PART NO.	DESCRIPTION
	ICs	
Q106	222570	NJM4560DX
	Transistors	
Q101-Q104	2211783 or 2211782	2SA991(E) or 2SA991(F)
	Diodes	
D101-D104	223145	1S2076TD
	Capacitors	
C101	379122237	0.022 μ F, 50V, DEW
C103, C104	372123314	330pF, 50V, Styrene [G][Q]
C107, C108, C109 C110	379128225	0.0082 μ F, 50V, DEW [G][Q]
C111, C112	352751009	10 μ F, 25V, Elect.
C115, C116	372122215	220pF, 50V, Styrene
C119, C120	379124725	0.0047 μ F, 50V, DEW
C121, C122	379121034	0.01 μ F(J), 50V, DEW
C123, C124	379128224	0.0082 μ F, 50V, DEW
C125, C126	379122034	0.02 μ F, 50V, DEW
C127, C128	352721029	1000 μ F, 6.3V, Elect.
C129, C130	352780229	2.2 μ F, 50V, Elect.
C131, C132	379121225	0.0012 μ F, 50V, DEW
C141, C142	352751019	100 μ F, 25V, Elect.
	Etc.	
L101, L102	231030	NCH-1070, Coil [G][Q]
S101a	25065229 25045034	NSS-63100, Remote switch NPJ-2PDBL10, INPUT Terminal

POWER AMPLIFIER PC BOARD 1 (NADA-2286b/c) PARTS LIST

CIRCUIT NO.	PART NO.	DESCRIPTION
	ICs	
Q519, Q520	222502	NJM4558DX
	Transistors	
Q501, Q502	2211915 or 2211916 or 2211917	2SK240(GR) or 2SK240(BL) or 2SK240(V)
Q503-Q506	2211733 or 2211732	2SC1845(E) or 2SC1845(F)
Q507-Q512	2211455 or 2210803	2SA1015(GR) or 2SA733(P)
Q513, Q514	2211354 or 2211353	2SA949(Y) or 2SA949(O)
Q515, Q516	2211634 or 2211633	2SC2229(Y) or 2SC2229(O)
Q517, Q518 Q901	2211255 2201512 or 2201513 or 2201074	2SC1815(GR) 2SD1200(Q) or 2SD1200(R) or 2SD880(Y)
Q902	2201502 or 2201503 or 2201244	2SB889(Q) or 2SB889(R) or 2SB834(Y)
	Diodes	
D501-D504 D507-D510 D513, D514 D517-D520	223145	1S2076TD
D505, D506, D511 D512	225126	GL-3PR1, LED
D515, D516	4000068	VD1222, Varistor

CIRCUIT NO.	PART NO.	DESCRIPTION
D901, D902	2241232 or 2239754 or 2243294	GZA-22Y or RD22E-B4 or MTZ22-D, Zener
	Capacitors	
C501, C502	372126805	68pF, 50V, Styrene
C505, C506	379121235	0.012 μ F, 50V, DEW
C509, C510	379122237	0.022 μ F, 50V, DEW
C513-C516	352752209	22 μ F, 25V, Elect.
C519, C520	379123935	0.039 μ F, 50V, DEW
C901, C902	352781019	100 μ F, 50V, Elect.
C903, C904	352754709	47 μ F, 25V, Elect.
C905, C906	352754719	470 μ F, 25V, Elect.
	Resistors	
R523, R524	442520684	6.8 Ω , 1/2W, Metal oxide film
R525, R526	442525614	560 Ω , 1/2W, Metal oxide film
R527, R528	442524334	43k Ω , 1/2W, Metal oxide film
R531, R532	5225019	N10HR4.7KBD, Semi-fixed
R533, R534	442524724	4.7k Ω , 1/2W, Metal oxide film
R549, R550	442520474	4.7 Ω , 1/2W, Metal oxide film
R901, R902	441523914	390 Ω , 1/2W, Metal oxide film
	Etc.	
S301	25030195	NRSM-146-30SS, Switch
S302	25030258 25045137	NRSM-166-30SS, Switch NPJ-6PDBL52, INPUT terminal
P304, P306	25050140	NJPS-3P-S, Socket

INPUT SELECTOR SWITCH PC BOARD (NASW-2156a/b) PARTS LIST

CIRCUIT NO.	PART NO.	DESCRIPTION
C331, C332	372122214	220pF, 50V Capacitors, Styrene [G][Q]
S303	25035442	NPS-642-L406, Switch
P303, P305	25050140	NJPS-3P-S, Sockets

POWER AMPLIFIER PC BOARD 2 (NAMA-2157e/f) PART LIST

CIRCUIT NO.	PART NO.	DESCRIPTION
	IC	
Q701	222584	TA7317P
	Transistors	
Q601, Q602	2211732 or 2211733	2SC1845(F) or 2SC1845(E)
Q603, Q603	2211792 or 2211793	2SA992(F) or 2SA992(E)
Q605, Q606	2211923 or 2211924 or 2212653 or 2212654	2SC2824(O) or 2SC2824(Y) or 2SC3421(O) or 2SC3421(Y)
Q607, Q608	2211933 or 2211934 or 2212643 or 2212644	2SA1184(O) or 2SA1184(Y) or 2SA1358(O) or 2SA1358(Y)
Q617, Q618	2211733 or 2211732	2SC1845(E) or 2SC1845(F)
	Diodes	
D701	223862	WL-01

CIRCUIT NO.	PART NO.	DESCRIPTION
D702, D704 D703	223145 2240972 or 2240973 or 2239492 or 2239493 or 2243162 or 2243163	1S2076TD GZA6.2Y or GZA6.2Z or RD6.2E-B2 or RD6.2E-B3 or MTZ6.2-B or MTZ6.2-C
Coils		
L601, L602 L603, L604	231015 230904	S-0.8C B-20L-44, Core (FR)
Capacitors		
C605, C606 C607, C608 C611-C614 C701 C703 C704 C706 C707 C708, C710	379121047 379124735 379121045 352722219 352732209 352784799 352743319 352744719 379122237	0.1 μ F, 50V, DEW 0.047 μ F, 50V, DEW 0.1 μ F, 50V, DEW 220 μ F, 6.3V, Elect. 22 μ F, 10V, Elect. 0.47 μ F, 50V, Elect. 330 μ F, 16V, Elect. 470 μ F, 16V, Elect. 0.022 μ F, 50V, DEW
Resistors		
R601, C602 R603, R604 R607-R610 R615, R616 R619, R620 R617, R618 R623, R624 R629-R632 R639-R642 R713	442522224 442522214 442520224 4000080 441620154 4000061 441621604 442523304	2.2k Ω , 1/2W, Metal oxide film 220 Ω , 1/2W, Metal oxide film 2.2 Ω , 1/2W, Metal oxide film 0.47 Ω , 5W, Metal plate 1.5 Ω , 1W, Metal oxide film 0.33 Ω , 2W, Metal plate 16 Ω , 1W, Metal oxide film 33 Ω , 1/2W, Metal oxide film
Etc.		
PL701 RL701	210183 25065036	PL14V 0.06A W-2.0, Lamp NRL-4P3A-DC12-01, Relay

LED CIRCUIT PC BOARD (NADIS-2287) PARTS LIST

CIRCUIT NO.	PART NO.	DESCRIPTION
D301-D306	225174 or 225173 27190316A	SLR55MC3N or SLR55MC3M, LED Holder LED

SWITCH CIRCUIT PC BOARD (NASW-2163b) PARTS LIST

CIRCUIT NO.	PART NO.	DESCRIPTION
C311, C312 S305 S306, (S307)	352781599 25035266 25035265	0.15 μ F, 50V, Capacitor, Elect. NPS-122-L230, Switch NPS-222-L229, Switch

TONE CONTROLE PC BOARD (NATC-2164b) PARTS LIST

CIRCUIT NO.	PART NO.	DESCRIPTION
Capacitors		
C315, C316 C317, C318 C319, C320 C321, C322	379121235 379125625 379121025 379123335	0.012 μ F, 50V, DEW 0.0056 μ F, 50V, DEW 0.001 μ F, 50V, DEW 0.033 μ F, 50V, DEW
Resistors		
R317	5148044	N16RGMC250KMN30, Variable

CIRCUIT NO.	PART NO.	DESCRIPTION
R321	5148046A	N16RGM11C219K30, Variable
R323	5148045A	N16RQM11C110K180K30 Variable

VOLUME CONTROL PC BOARD (NAVR-2166) PARTS LIST

CIRCUIT NO.	PART NO.	DESCRIPTION
R351	5172062	N16RGL100KBTP30, Variable resistor

SPEAKER SWITCH & POWER SUPPLY PC BOARD (NAPS-2167c) PARTS LIST

CIRCUIT NO.	PART NO.	DESCRIPTION
Diodes		
D951-D957 D959, D960	223841 223842	GP-30G GP-15B
Capacitors		
C951-C953 C954, C955	380504745 3504172	0.47 μ F, 160V, CF 15000 μ F, 59V, Elect.
Resistors		
R753, R754 R951	441623914 442525104	390 Ω , 1W, Metal oxide film 51 Ω , 1/2W, Metal oxide film
Etc.		
	25030257 25045164 27300731 27300732	NRSM-164-30SS, Switch HLJ4317-01-3020, Head- phone jack Plate (C) Plate (P)

SPEAKER TERMINAL PC BOARD (NATS-2168/a) PARTS LIST

CIRCUIT NO.	PART NO.	DESCRIPTION
C751, C753	379121025 25060039	0.001 μ F, 50V, Capacitor DEW [G][Q] NTM-4PDMN10, Terminal

LED CIRCUIT PC BOARD (NADIS-2169) PARTS LIST

CIRCUIT NO.	PART NO.	DESCRIPTION
D711	225174 225173 27190319A	SLR55MC3N, LED SLR55MC3M, LED Holder LED

FUSE PC BOARD (NAFU-2203d/e/h) PARTS LIST

CIRCUIT NO.	PART NO.	DESCRIPTION
	250113 25050065 22360462 29360405 29355121	S-N5051, Fuse holder [D] YSH403T, Fuse holder [G][Q] 5A/125V, Fuse label [W] T2.5A/250V, Fuse label [G][Q] P-2, Caution label [D]

NOTE: [D] : Only 120V model
[G] : Only 220V model
[W] : Only 120V/240V model
[Q] : Only 240V model

PACKING PROCEDURES

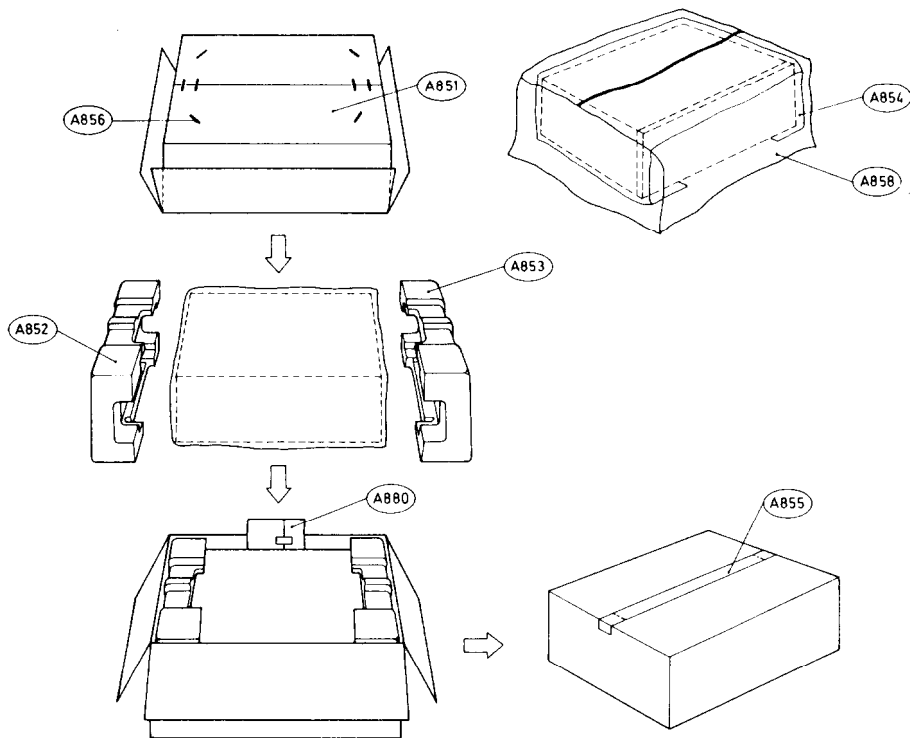

REF. NO.	PART NO.	DESCRIPTION
A851	29051084	Master carton box
	29051085	Master carton box [BLACK]
A852	29090488C	Pad, left
A853	29090489B	Pad, right
A854	29095012-1	500 × 800, Protection sheet
A855	260012	Damplon tape
A856	282301	Sealing hook
A858	29100038A	720 × 950, Poly bag
A880	Accessory bag ass'y	
	29340845	Instruction manual [D]
	29340846	Instruction manual [G] [W]
	29365006-7	Warranty card [U]
	29358002C	Service station list [U]
	29100006A	350 × 250, Poly bag
	25055018	CV-K-1, Conversion plug [W]

NOTE:

- [U]: Only U.S.A. model
- [D]: Only 120V model
- [G]: Only 220V/240V model
- [W]: Only 120V/220V model
- [BLACK]: Black model