



For more Hi-Fi manuals and set-up information
please visit www.hifiengine.com

The Harman Kardon Model PM645 Vxi

Manual 120A

STEREO INTEGRATED AMPLIFIER

Technical Manual

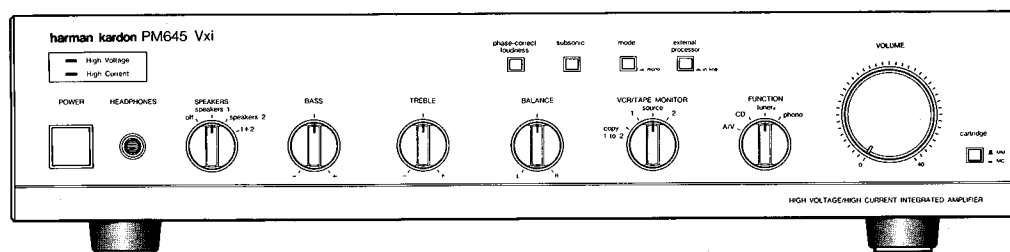

The following marks found in the parts list of this manual identify the models as follows.

- UA : North America area model
- BK : North America area model Black version
- G : General model
- GB : General model Black version
- N : Japan model

harman/kardon

240 Crossways Park West, Woodbury, N.Y. 11797
1112-3152120A4 P-088710 1500 Printed in Japan

PM645 Vxi

SPECIFICATIONS

	Nominal	Limit
RMS Output Power		
8Ω, 1kHz THD 0.1%	70.8W	≥ 60W
4Ω, 1kHz THD 0.3%	72.2W	≥ 60W
High Instantaneous Current Capability (HCC)	40A	≥ 35A
Half Power Bandwidth	10Hz	~ 100kHz
Frequency Responce at -3dB	0.62Hz	~ 163kHz
Input Sensitivity		
Tuner	135mV	± 25mV
Phono(MM)	2.2mV	± 0.2mV*
Phono(MC)	120μV	± 20μV*
Signal to Noise Ratio		
Tuner	80.7dB	≥ 75dB
Phono(MM)	79.5dB	≥ 73dB
Phono(MC)	76.5dB	≥ 74dB
Channel Separation at 10kHz		
Tuner	66dB	≥ 50dB
Phono(MM)	58dB	≥ 45dB
Phono(MC)	50dB	≥ 43dB
IM Distortion Ratio	0.048%	≥ 0.1%
Damping Factor at 1kHz	60.3	≥ 50
Tone Control Characteristics		
Bass Turnover Frequency (200Hz/400Hz)		
Bass at 50Hz/100Hz		
Boost	10dB	± 2dB
Cut	10dB	± 2dB
Treble Turnover Frequency (2kHz/6kHz)		
Treble at 10kHz/30kHz		
Boost	10dB	± 2dB
Cut	10dB	± 2dB

	Nominal	Limit
Filters		
Subsonic	15Hz,	-3dB ± 1dB/Octave
High Cut	6kHz,	-3dB ± 1dB/Octave
DC Output Voltage		
L channel	0mV	± 60mV
R channel	0mV	± 60mV
RIAA Equalization at Tape Out (20Hz/20kHz) (No load)	0.18dB + 1.0dB/0.18dB	-0.2dB
Phono Over Load (No load)		
Phono (MM)	108mV	≥ 95mV
Phono (MC)	5.6mV	≥ 5mV
Dimensions (W x H x D)	17-1/2" x 4-1/16" x 13-7/8"	(443 x 103 x 351mm)
Weight	14 lbs.	5oz. (6.5kg)
Power Supplies		
North America area model	AC 120V,	60Hz
General model	AC 220/240V,	50/60Hz
Japan model	AC 100V,	50/60Hz
Power Consumption		
North America area model	248W	(300VA)
General model	176W	
Japan model	340W	

* Input Sensitivity for General model are 2.3mV ± 0.2mV (MM) and 145μV ± 20μV (MC).

This specification is the target of servicing. But, there is a case that the specification is not applicable to the measurement condition and instrument.

Specifications and components subject to change without notice. Overall performance will be maintained or improved.

LEAKAGE TEST (FOR SERVICE ENGINEERS IN THE U.S.A.)

Before returning the unit to the user, perform the following safety checks:

1. Inspect all lead dress to make certain that leads are not pinched or that hardware is not lodged between the chassis and other metal parts in the unit.
2. Be sure that any protective devices such as nonmetallic control knobs, insulating fishpapers, cabinet backs, adjustment and compartment covers or shields, isolation resistor-capacity networks, mechanical insulators, etc. which were removed for servicing are properly reinstalled.
3. Be sure that no shock hazard exists; check for leakage current using Simpson Model 229 Leakage Tester, standard equipment item No. 21641, RCA Model WT540A or use alternate method as follows: Plug the power cord directly into a 120-volt AC receptacle (do not use an Isolation Transformer for this test). Using two clip leads, connect a 1500 Ohm, 10-watt resistor paralleled by a 0.15 μF capacitor, in series with all exposed metal cabinet parts and a known earth ground, such as a water pipe or conduit. Use a VTVM or VOM with 1000 Ohms per volt, or higher sensitivity to measure the AC voltage drop across the resistor. (See Diagram.) Move the resistor connection to each exposed metal part having a return path to the chassis (antenna, metal, cabinet, screw heads, knobs and control shafts, escutcheon, etc.) and measure the AC voltage drop across the resistor. (This test should be performed with the power switch in both the On and Off positions.) A reading of 0.35 volt RMS or more is excessive and indicates a potential shock hazard which must be corrected before returning the unit to the owner.

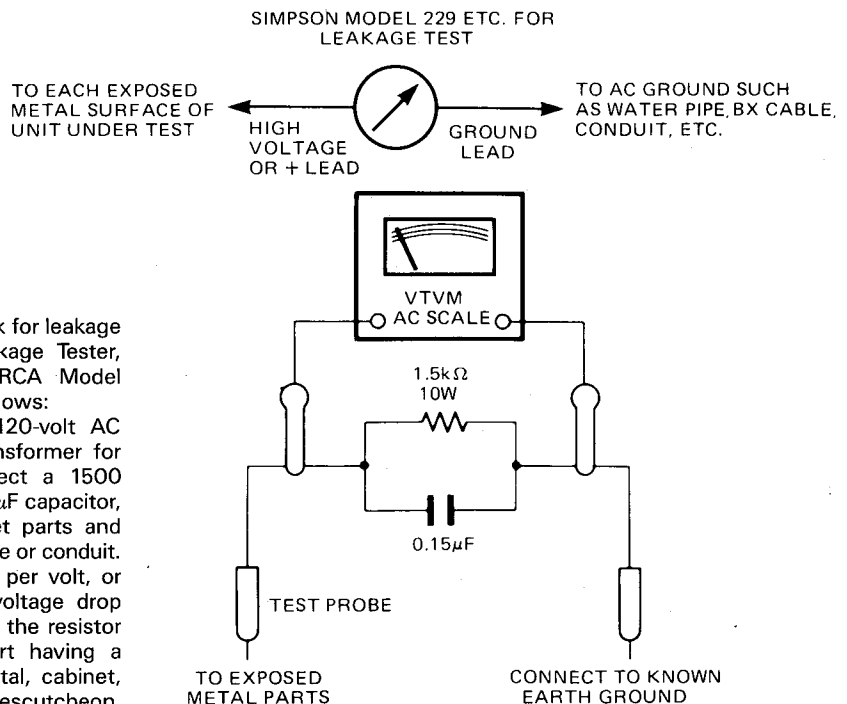

DISASSEMBLY PROCEDURES (REFER TO PAGES 5 AND 16)

① CABINET TOP (131) REMOVAL

Remove 6 screws (A) and then remove the Cabinet Top (131).

② FRONT PANEL ASS'Y (AA) REMOVAL

1. Remove the Cabinet Top (131), referring to the previous step ①.
2. Remove 5 screw (B) and then remove the Front Panel Ass'y (AA).

③ BASS CONTROL P. C. BOARD (PCB-9) REMOVAL

1. Remove the Front Panel Ass'y (AA), referring to the previous step ②.
2. Open the lid of connector (CN502) on the Main P. C. Board (PCB-1) and then disconnect the lead wires.
3. Open the lid of connector (CN501) on the Function P. C. Board (PCB-8) and then disconnect the lead wires.
4. Open the lid of connectors (CN503, CN504 and CN505) on the Bass Control P. C. Board (PCB-9) and then disconnect the lead wires.
5. Remove 2 screws (C) and then remove the Bass Control P. C. Board (PCB-9).
If necessary, unsolder the lead wire connected to the PCB-9.

④ MAIN P. C. BOARD (PCB-1) REMOVAL

1. Remove the Bass Control P. C. Board (PCB-9), referring to the previous step ③.
2. Open the lid of connectors (CN601 and CN803) on the Main P. C. Board (PCB-1) and then disconnect the lead wires.
3. Open the lid of connector (CN109) on the Function P. C. Board (PCB-8) and then disconnect the lead wires.
4. Remove a screw (D) and then remove the Q807 P. C. Board (PCB-12).
5. Remove 4 screws (E) and 3 hexagon nuts (F) and then remove the Main P. C. Board (PCB-1).
If necessary, unsolder the lead wires connected to the PCB-1.

⑤ FUNCTION P. C. BOARD (PCB-8) REMOVAL

1. Remove the Main P. C. Board (PCB-1), referring to the previous step ④.
2. Open the lid of connector (CN801) on the Function P. C. Board (PCB-8) and then disconnect the lead wires.
3. Remove 3 screws (G) and then remove the Video P. C. Board (PCB-10).
4. Pull out the Shafts (215 and 216).
5. Remove 11 screws (H) and then remove the Cabinet Back Ass'y (AB) with the Speakers P. C. Board (PCB-2).
6. Remove 2 screws (I) and 2 hexagon nuts (J) and then remove the Function P. C. Board (PCB-8) with the Equalizer P. C. Board (PCB-11).

POWER CORD REPLACEMENT (FOR SERVICE ENGINEERS OTHER THAN NOTRH AMERICA)

In order to prevent fire or shock hazard when replacing the power cord, follow the procedure below to replace the parts with the standard supply parts.

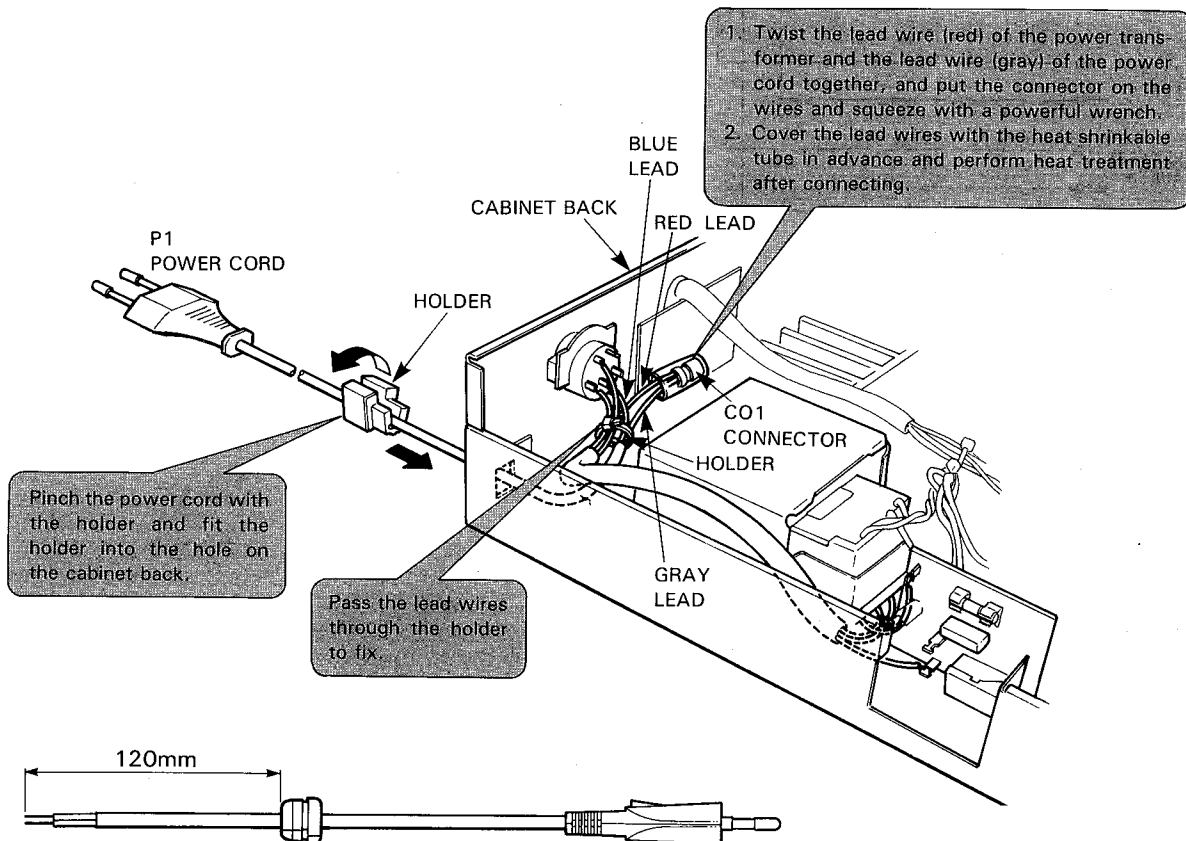

ALIGNMENT PROCEDURES (REFER TO PAGES 7, 8 AND 15)

- Conditions:
- Set the Volume control to minimum.
 - Set the Speaker selector to "1 + 2" position.
 - Set the Speaker Operating Mode switch to "8Ω" position.
 - Make the adjustment at a room temperature of 77°F (25°C).
 - After the Power switch is pushed on, wait for 30 minutes before measuring to be sure of the most stable operation.

IDLING CURRENT ADJUSTMENT

Step	Connection Equipments	Adjustment	For
1	Connect the Digital Volt Meter to TP1 and TP2.	VR401 (L ch)	40mV ± 2mV
2	Connect the Digital Volt Meter to TP3 and TP4.	VR402 (R ch)	40mV ± 2mV

BLOCK DIAGRAM

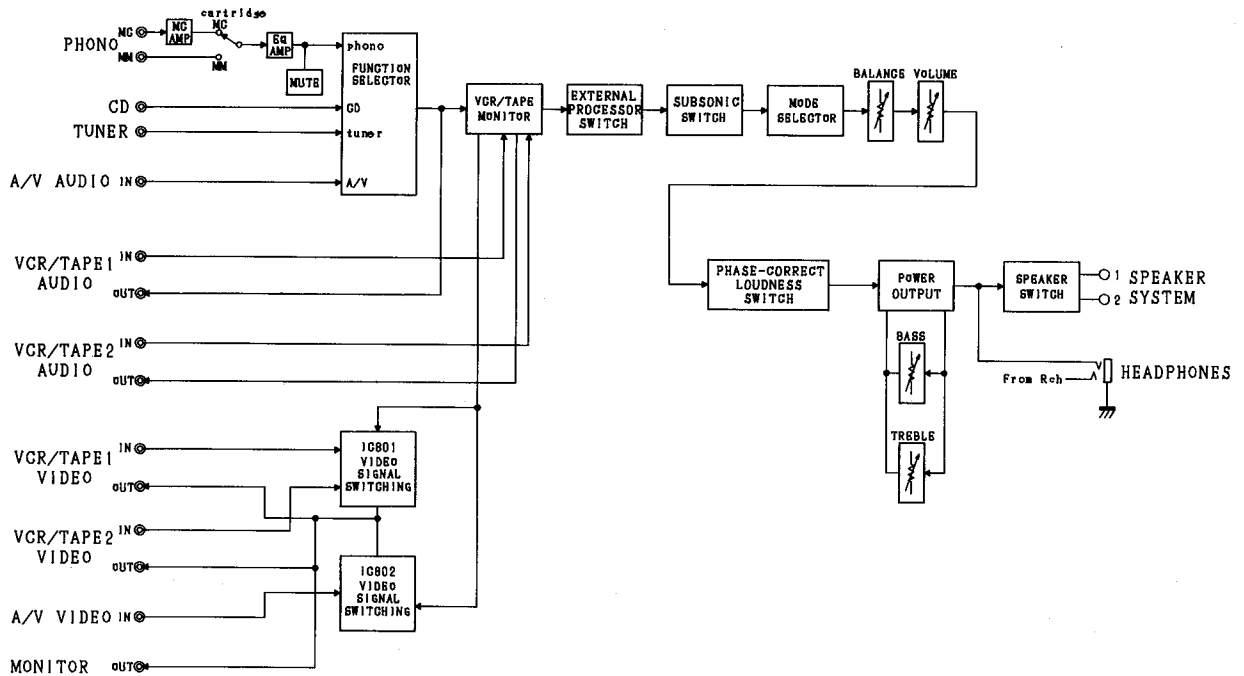

PARTS LIST

Ref. No.	Part No.	Description	Ref. No.	Part No.	Description
AA	A443-PM645S2A	FRONT PANEL ASS'Y UA G	236	2347-R0130062	SCREW, BND T+
AAA	A443-PM645S2B	FRONT PANEL ASS'Y BK GB N	237	2347-R0130084	SCREW, BND T+
AB	A424-PM645S2A	CABINET BACK ASS'Y	239	2347-R0130102	SCREW, BND T+
AC	A424-PM645S2B	CABINET BOTTOM ASS'Y	241	2347-R0140064	SCREW, BND T+
AD	A632-PM645S2A	ROTARY KNOB FUNCTION SWITCH ASS'Y UA G	242	2347-R0140082	SCREW, BND T+
ADA	A632-PM645S2B	ROTARY KNOB FUNCTION SWITCH ASS'Y BK GB N	245	2557-301029	SCREW, B SPW+
AE	A662-PM645S2A	PUSH BUTTON ASS'Y UA G	ΔPI	4161-71151	CORD W/PLUG UA BK
AEA	A662-PM645S2B	PUSH BUTTON ASS'Y BK GB N	ΔPIB	4161-7256	CORD W/PLUG G GB
023B	2132-7116	SPACER G GB	ΔPID	4161-71133	CORD W/PLUG N
024B	2327-R0130124	SCREW, BND+ G GB	ΔTI	5584-S11	XFORMER, POWER UA BK
025B	2440-7017	NUT, SPE G GB N	ΔTID	5584-S12	XFORMER, POWER G GB
053B	4150-8	TUBING, SPE G GB	ΔTID	5584-S13	XFORMER, POWER N
064B	2132-7120	SPACER G GB	ΔSO1	4474-156	SOCKET, AC OUTLET
065B	2347-R0130162	SCREW, BND T+ G GB	LUG1B	4211-4	LUG G GB
116	1756-05910	LABEL, FUSE CAUTION	LUG2	4211-4	LUG
131	1414-04901	CABINET TOP	ΔSW2	4421-0227230	SWITCH, SLIDE
133	1424-23201	CABINET BOTTOM	ΔSW101	4411-102729	SWITCH, ROTARY G GB
134	1424-23004	CABINET BACK UA BK	Q427	5614-669A(C)	XISTOR, NPN A
134B	1424-23006	CABINET BACK G GB	Q428	5614-669A(C)	XISTOR, NPN A
134D	1424-23005	CABINET BACK N	Q429	5612-649A(C)	XISTOR, PNP A
136	1443-11303	FRONT PANEL UA G	Q430	5612-649A(C)	XISTOR, PNP A
136A	1443-11304	FRONT PANEL BK GB N	Q431	5613-3182(O)or(R)	XISTOR, NPN R
138	1513-09501	PANEL, PLATE	Q432	5613-3182(O)or(R)	XISTOR, NPN R
139	1531-11304	PANEL, WINDOW	Q433	5611-1265(O)or(R)	XISTOR, PNP R
141	1562-02801	FRAME, RIGHT UA G	Q434	5611-1265(O)or(R)	XISTOR, PNP R
141A	1562-02802	FRAME, RIGHT BK GB N	Q613	5613-3422(Y)or(O)	XISTOR, NPN R
142	1562-02701	FRAME, LEFT UA G	D401	5641-MV12YM	VARISTOR
142A	1562-02702	FRAME, LEFT BK GB N	D402	5641-MV12YM	VARISTOR
146	1660-00401	PUSH BUTTON, POWER UA G			
146A	1660-00403	PUSH BUTTON, POWER BK GB N			
147	1662-05701VN	PUSH BUTTON UA G			
147A	1662-05702	PUSH BUTTON BK GB N			
150	1630-02601	ROTARY KNOB, VOLUME UA G			
150A	1630-02603	ROTARY KNOB, VOLUME BK GB N			
152	1630-16502	ROTARY KNOB, FUNCTION SWITCH UA G			
152A	1630-16501	ROTARY KNOB, FUNCTION SWITCH BK GB N			
153	1630-16502	ROTARY KNOB UA G			
153A	1630-16501	ROTARY KNOB BK GB N			
157	1319-0139	LEG UA			
161	2211-7295	CHASSIS			
163	2219-8179	METAL FITTING, MAIN HEAT SINK			
164	2219-8178	METAL FITTING, SHAFT GUIDE			
172	2219-8181	METAL FITTING, EQ PCB			
173	2219-8182	METAL FITTING, MAIN HEAT SINK			
174	2219-7879	METAL FITTING, H/P JACK			
177	2222-7228	HEAT SINK, MAIN UA BK N			
177B	2222-7233	HEAT SINK, MAIN G GB			
178	2222-7214	HEAT SINK, DRIVER			
179	2222-7067	HEAT SINK, DRIVER MONO			
180	2222-7230	HEAT SINK, EQ			
182	2240-7320	HOLDER, POWER SWITCH			
183	2240-7141	HOLDER UA G			
183A	2240-7202	HOLDER BK GB N			
186	2240-7209	HOLDER, POWER			
187	2240-7315	HOLDER, LED			
188	2240-7316	HOLDER, PANEL			
189	2240-7050	HOLDER, WIRING			
190	2240-7176	HOLDER, FUSE			
191	2240-364	HOLDER, AC CORD			
197	2112-11755	SPONGE, SIDE			
198	2112-11762	SPONGE, PANEL			
199	2112-11784	SPONGE, CASSIS			
206	2401-0376	WASHER, METAL			
211	2310-7017	SCREW, SPE			
213	2672-7018	LEVER, POWER SHAFT			
214	2601-7077	SHAFT			
215	2601-7170	SHAFT, MC/MM SWITCH			
216	2601-7165	SHAFT, MC/MM BUTTON			
220	2651-210189	SPRING, PUSH BUTTON			
224	2360-7015	BOSS, SPE			
225	2327-R0130064	SCREW, BND+			
228	2327-R0130082	SCREW, BND+			
229	2327-R0130082	SCREW, BND+			
235	2347-R0130062	SCREW, BND T+			

P. C. BOARDS

PCB-1 Main P. C. Board

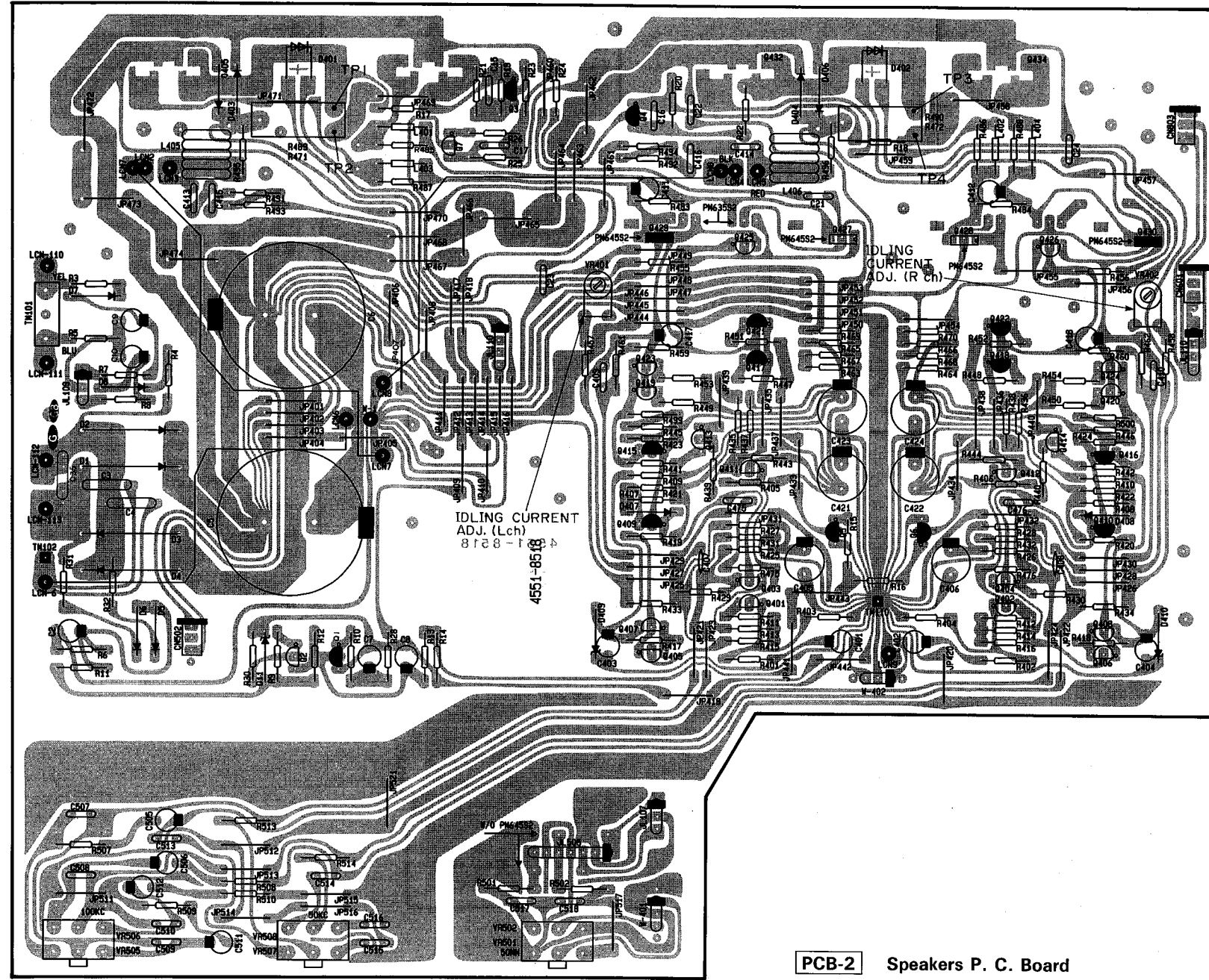

BASS TREBLE BALANCE

PCB-3 Headphone P. C. Board



PCB-4 LED P. C. Board

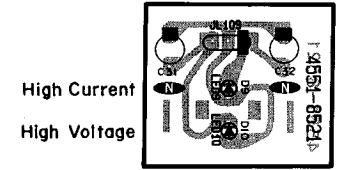

PCB-5 Speakers P. C. Board

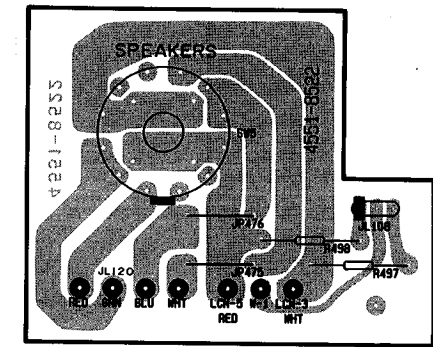

PCB-6 VR P. C. Board

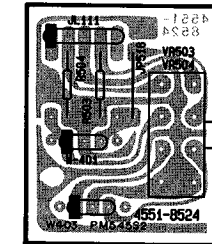

PCB-2 Speakers P. C. Board

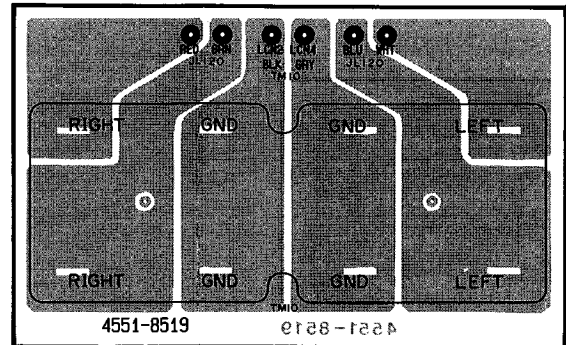

PCB-7 Power Switch P. C. Board

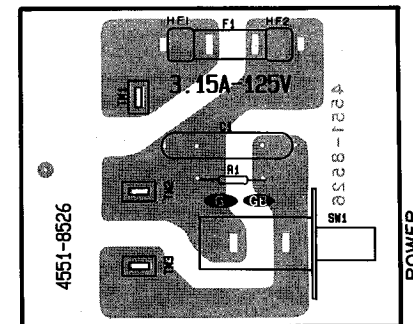

P. C. BOARDS

PCB-1 Main P. C. Board

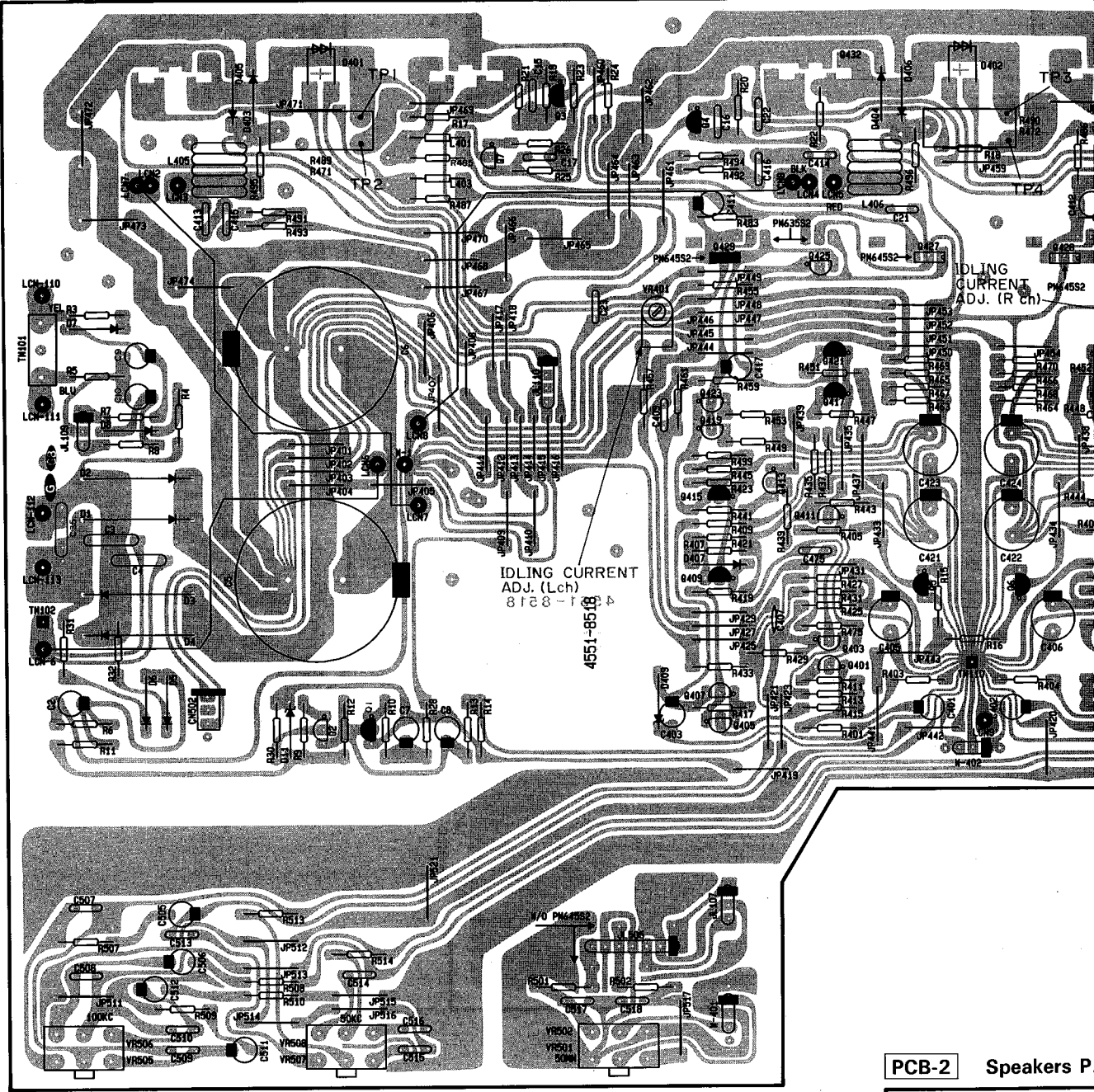

PCB-2 Speakers P

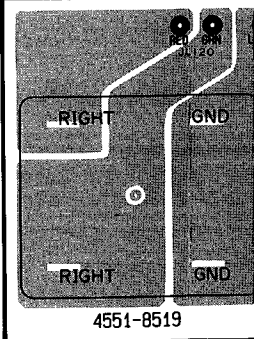

P. C. BOARDS

PCB-8 Function P. C. Board

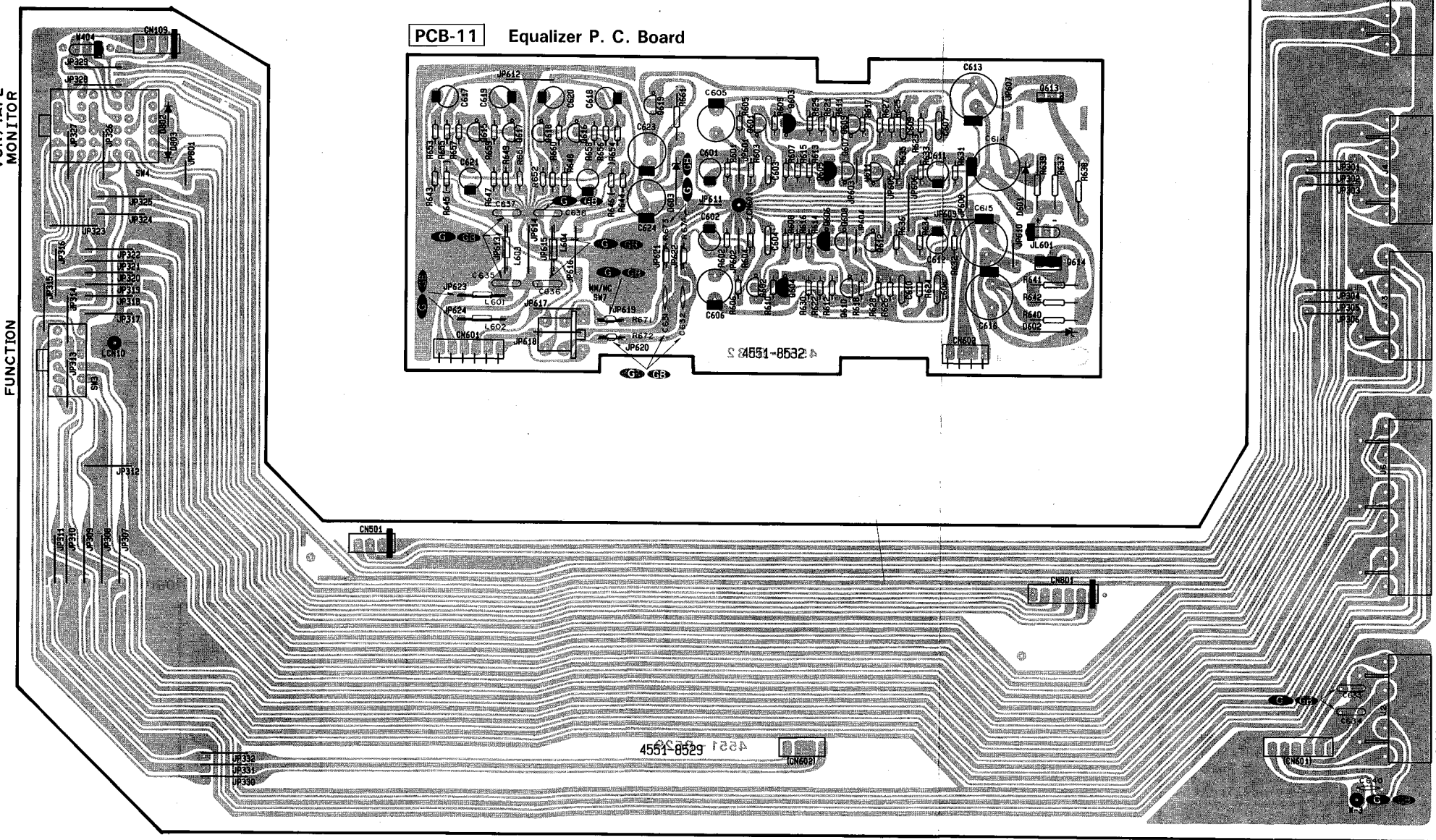

PCB-10 Video P. C. Board

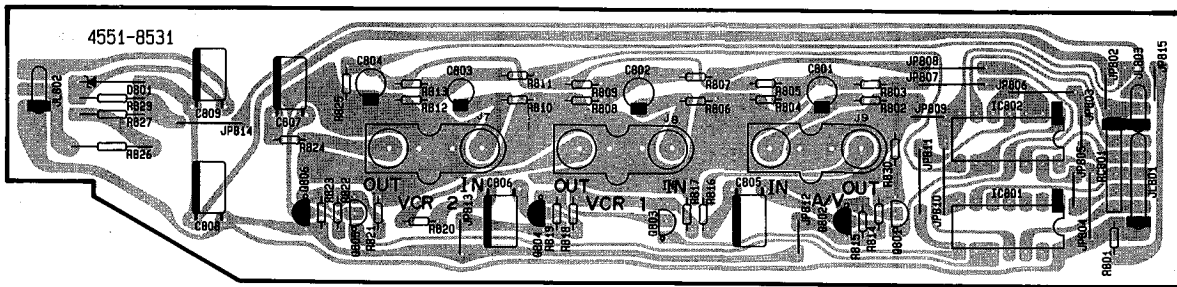

PCB-12 Q807 P. C. Board



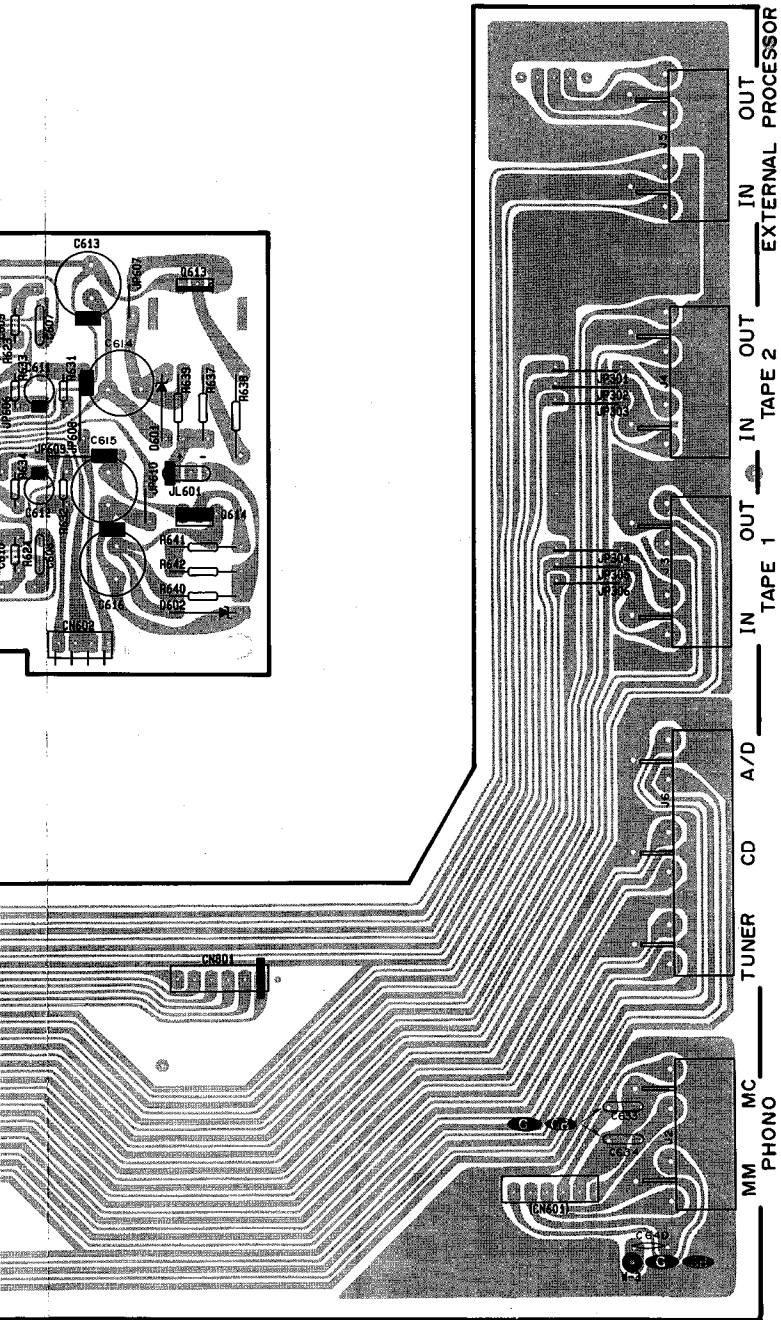

PCB-12 Q807 P. C. Board

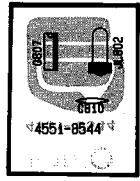

PCB-9 Bass Control P. C. Board

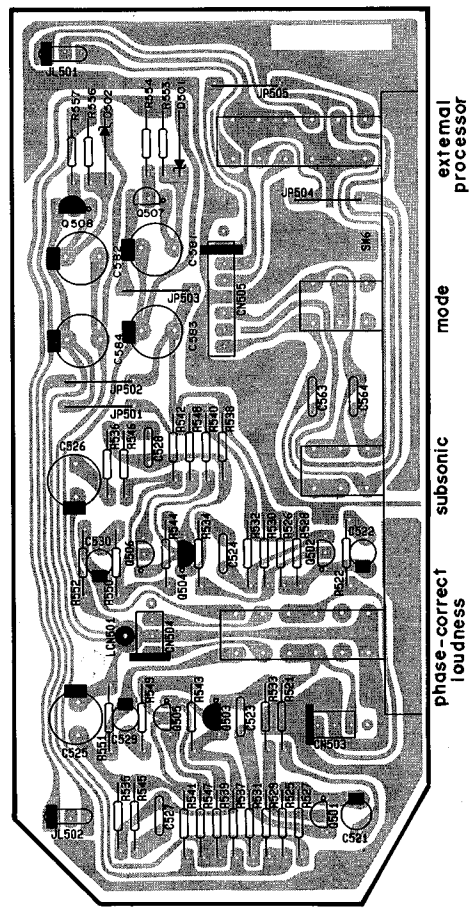

ELECTRICAL PARTS LIST

Ser. No.	Ref. No.	Part No.	Description	Ser. No.	Ref. No.	Part No.	Description
PCB-1 MAIN P.C. BOARD							
CAPACITORS							
662	C2	5345-106F041	CAP, MINI ELE 10 μ /50V	672	R15	5135-223522	RES, CBN 1/2P 22K
689	C3	5362-103048	CAP, CER .01 μ	672	R16	5135-223522	RES, CBN 1/2P 22K
689	C4	5362-103048	CAP, CER .01 μ	674	R17	5135-562522	RES, CBN 1/2P 5.6K
687	C5	5341-109G0355	CAP, ELE 10000 μ /63V	674	R18	5135-562522	RES, CBN 1/2P 5.6K
687	C6	5341-109G0355	CAP, ELE 10000 μ /63V	673	R19	5135-122522	RES, CBN 1/2P 1.2K
660	C7	5345-105F041	CAP, MINI ELE 1 μ /50V	673	R20	5135-122522	RES, CBN 1/2P 1.2K
661	C8	5345-107B041	CAP, MINI ELE 100 μ /10V	674	R21	5135-562522	RES, CBN 1/2P 5.6K
659	C9	5345-106C041	CAP, MINI ELE 10 μ /16V	674	R22	5135-562522	RES, CBN 1/2P 5.6K
659	C10	5345-106C041	CAP, MINI ELE 10 μ /16V	670	R23	5135-472522	RES, CBN 1/2P 4.7K
663	C15	5354-683J1HM	CAP, MYL .068 μ	670	R24	5135-472522	RES, CBN 1/2P 4.7K
663	C16	5354-683J1HM	CAP, MYL .068 μ	671	R25	5135-473522	RES, CBN 1/2P 47K
664	C17	5354-473J1HM	CAP, MYL .047 μ	672	R26	5135-223522	RES, CBN 1/2P 22K
665	C21	5354-104593	CAP, MYL .1 μ	671	R28	5135-473522	RES, CBN 1/2P 47K
665	C22	5354-104593	CAP, MYL .1 μ	668	R30	5135-103522	RES, CBN 1/2P 10K
665	C23	5354-104593	CAP, MYL .1 μ	667	R31	5135-822522	RES, CBN 1/2P 8.2K
665	C24	5354-104593	CAP, MYL .1 μ	667	R32	5135-822522	RES, CBN 1/2P 8.2K
057B	C35	5352-1041957	CAP, MTL .1 μ	603	R401	5135-102522	RES, CBN 1/2P 1K
581	C401	5345-476B0951	CAP, MINI ELE 47 μ /10V	603	R402	5135-102522	RES, CBN 1/2P 1K
581	C402	5345-476B0951	CAP, MINI ELE 47 μ /10V	604	R403	5135-683522	RES, CBN 1/2P 68K
583	C403	5345-106C041	CAP, MINI ELE 10 μ /16V	604	R404	5135-683522	RES, CBN 1/2P 68K
583	C404	5345-106C041	CAP, MINI ELE 10 μ /16V	605	R405	5135-122522	RES, CBN 1/2P 1.2K
582	C405	5345-227A0951	CAP, MINI ELE 220 μ /6.3V	605	R406	5135-122522	RES, CBN 1/2P 1.2K
582	C406	5345-227A0951	CAP, MINI ELE 220 μ /6.3V	605	R407	5135-122522	RES, CBN 1/2P 1.2K
592	C407	5353-020934	CAP, MCA 2p	605	R408	5135-122522	RES, CBN 1/2P 1.2K
592	C408	5353-020934	CAP, MCA 2p	606	R409	5135-822522	RES, CBN 1/2P 8.2K
590	C409	5359-1015851	CAP, PPP 100p	606	R410	5135-822522	RES, CBN 1/2P 8.2K
590	C410	5359-1015851	CAP, PPP 100p	607	R411	5135-680522	RES, CBN 1/2P 68
583	C411	5345-106C041	CAP, MINI ELE 10 μ /16V	607	R412	5135-680522	RES, CBN 1/2P 68
583	C412	5345-106C041	CAP, MINI ELE 10 μ /16V	607	R413	5135-680522	RES, CBN 1/2P 68
595	C413	5354-683J1HM	CAP, MYL .068 μ	607	R414	5135-680522	RES, CBN 1/2P 68
595	C414	5354-683J1HM	CAP, MYL .068 μ	623	R415	5135-222522	RES, CBN 1/2P 2.2K
595	C415	5354-683J1HM	CAP, MYL .068 μ	623	R416	5135-222522	RES, CBN 1/2P 2.2K
595	C416	5354-683J1HM	CAP, MYL .068 μ	609	R417	5135-561522	RES, CBN 1/2P 560
583	C417	5345-106C041	CAP, MINI ELE 10 μ /16V	609	R418	5135-561522	RES, CBN 1/2P 560
583	C418	5345-106C041	CAP, MINI ELE 10 μ /16V	604	R419	5135-683522	RES, CBN 1/2P 68K
584	C421	5345-337F041	CAP, MINI ELE 330 μ /50V	604	R420	5135-683522	RES, CBN 1/2P 68K
584	C422	5345-337F041	CAP, MINI ELE 330 μ /50V	638	Δ R421	5102-3314715	RES, FUSE 330
584	C423	5345-337F041	CAP, MINI ELE 330 μ /50V	638	Δ R422	5102-3314715	RES, FUSE 330
584	C424	5345-337F041	CAP, MINI ELE 330 μ /50V	638	Δ R423	5102-3314715	RES, FUSE 330
590	C475	5359-1015851	CAP, PPP 100p	638	Δ R424	5102-3314715	RES, FUSE 330
590	C476	5359-1015851	CAP, PPP 100p	610	R425	5135-473522	RES, CBN 1/2P 47K
585	C505	5345-225F0951	CAP, MINI ELE 2.2 μ /50V	610	R426	5135-473522	RES, CBN 1/2P 47K
585	C506	5345-225F0951	CAP, MINI ELE 2.2 μ /50V	610	R427	5135-473522	RES, CBN 1/2P 47K
596	C507	5354-563J1HM	CAP, MYL .056 μ	610	R428	5135-473522	RES, CBN 1/2P 47K
596	C508	5354-563J1HM	CAP, MYL .056 μ	611	R429	5135-224522	RES, CBN 1/2P 220K
599	C509	5354-224593	CAP, MYL .22 μ	611	R430	5135-224522	RES, CBN 1/2P 220K
599	C510	5354-224593	CAP, MYL .22 μ	618	R431	5135-750522	RES, CBN 1/2P 75
586	C511	5345-106C0951	CAP, MINI ELE 10 μ /16V	618	R432	5135-750522	RES, CBN 1/2P 75
586	C512	5345-106C0951	CAP, MINI ELE 10 μ /16V	612	R433	5135-272522	RES, CBN 1/2P 2.7K
597	C513	5354-822J1HM	CAP, MYL 8200p	612	R434	5135-272522	RES, CBN 1/2P 2.7K
597	C514	5354-822J1HM	CAP, MYL 8200p	613	R435	5135-223522	RES, CBN 1/2P 22K
598	C515	5354-393J1HM	CAP, MYL .039 μ	613	R436	5135-223522	RES, CBN 1/2P 22K
598	C516	5354-393J1HM	CAP, MYL .039 μ	613	R437	5135-223522	RES, CBN 1/2P 22K
591	C517	5359-3315851	CAP, PPP 330p	613	R438	5135-223522	RES, CBN 1/2P 22K
591	C518	5359-3315851	CAP, PPP 330p	624	R439	5135-153522	RES, CBN 1/2P 15K
RESISTORS							
680	Δ R3	5102-2204715	RES, FUSE 22	614	R441	5135-123522	RES, CBN 1/2P 12K
680	Δ R4	5102-2204715	RES, FUSE 22	614	R442	5135-123522	RES, CBN 1/2P 12K
679	Δ R5	5102-5R64715	RES, FUSE 5.6	633	R443	5174-222381	RES, MTL 1/4P 2.2K
668	R6	5135-103522	RES, CBN 1/2P 10K	633	R444	5174-222381	RES, MTL 1/4P 2.2K
677	R7	5135-221522	RES, CBN 1/2P 220	633	R445	5174-222381	RES, MTL 1/4P 2.2K
677	R8	5135-221522	RES, CBN 1/2P 220	633	R446	5174-222381	RES, MTL 1/4P 2.2K
670	R9	5135-472522	RES, CBN 1/2P 4.7K	636	Δ R447	5102-1014715	RES, FUSE 100
670	R10	5135-472522	RES, CBN 1/2P 4.7K	636	Δ R448	5102-1014715	RES, FUSE 100
667	R11	5135-822522	RES, CBN 1/2P 8.2K	636	Δ R449	5102-1014715	RES, FUSE 100
669	R12	5135-104522	RES, CBN 1/2P 100K	636	Δ R450	5102-1014715	RES, FUSE 100
675	R13	5135-683522	RES, CBN 1/2P 68K	636	Δ R451	5102-1014715	RES, FUSE 100
676	R14	5135-333522	RES, CBN 1/2P 33K	636	Δ R452	5102-1014715	RES, FUSE 100
				636	Δ R453	5102-1014715	RES, FUSE 100
				636	Δ R454	5102-1014715	RES, FUSE 100
				615	R455	5135-821522	RES, CBN 1/2P 820
				615	R456	5135-821522	RES, CBN 1/2P 820
				615	R457	5135-821522	RES, CBN 1/2P 820

Ser. No.	Ref. No.	Part No.	Description
615	R458	5135-821522	RES, CBN 1/2P 820
625	R459	5135-183522	RES, CBN 1/2P 18K
625	R460	5135-183522	RES, CBN 1/2P 18K
625	R461	5135-183522	RES, CBN 1/2P 18K
625	R462	5135-183522	RES, CBN 1/2P 18K
617	R463	5135-100522	RES, CBN 1/2P 10
617	R464	5135-100522	RES, CBN 1/2P 10
617	R465	5135-100522	RES, CBN 1/2P 10
617	R466	5135-100522	RES, CBN 1/2P 10
637	ΔR467	5102-1004715	RES, FUSE 10
637	ΔR468	5102-1004715	RES, FUSE 10
637	ΔR469	5102-1004715	RES, FUSE 10
637	ΔR470	5102-1004715	RES, FUSE 10
639	R471	5273-R27672	RES, CEM 3P .27
639	R472	5273-R27672	RES, CEM 3P .27
605	R475	5135-122522	RES, CBN 1/2P 1.2K
605	R476	5135-122522	RES, CBN 1/2P 1.2K
616	R483	5135-820522	RES, CBN 1/2P 82
616	R484	5135-820522	RES, CBN 1/2P 82
617	R485	5135-100522	RES, CBN 1/2P 10
617	R486	5135-100522	RES, CBN 1/2P 10
617	R487	5135-100522	RES, CBN 1/2P 10
617	R488	5135-100522	RES, CBN 1/2P 10
639	R489	5273-R27672	RES, CEM 3P .27
639	R490	5273-R27672	RES, CEM 3P .27
627	R491	5135-4R7522	RES, CBN 1/2P 4.7
627	R492	5135-4R7522	RES, CBN 1/2P 4.7
627	R493	5135-4R7522	RES, CBN 1/2P 4.7
627	R494	5135-4R7522	RES, CBN 1/2P 4.7
626	R495	5135-220522	RES, CBN 1/2P 22
626	R496	5135-220522	RES, CBN 1/2P 22
607	R499	5135-680522	RES, CBN 1/2P 68
607	R500	5135-680522	RES, CBN 1/2P 68
619	R501	5135-152522	RES, CBN 1/2P 1.5K
619	R502	5135-152522	RES, CBN 1/2P 1.5K
620	R507	5135-822522	RES, CBN 1/2P 8.2K
620	R508	5135-822522	RES, CBN 1/2P 8.2K
621	R509	5135-182522	RES, CBN 1/2P 1.8K
621	R510	5135-182522	RES, CBN 1/2P 1.8K
622	R513	5135-271522	RES, CBN 1/2P 270
622	R514	5135-271522	RES, CBN 1/2P 270

TRANSISTORS

652	Q1	5611-1115(F)or(E)	XISTOR, PNP R
651	Q2	5613-2603(F)or(E)	XISTOR, NPN R
653	Q3	5611-970(BL)	XISTOR, PNP R
653	Q4	5611-970(BL)	XISTOR, PNP R
653	Q5	5611-970(BL)	XISTOR, PNP R
653	Q6	5611-970(BL)	XISTOR, PNP R
654	Q7	5613-2240(BL)	XISTOR, NPN R
561	Q401	5613-2240(BL)	XISTOR, NPN R
561	Q402	5613-2240(BL)	XISTOR, NPN R
561	Q403	5613-2240(BL)	XISTOR, NPN R
561	Q404	5613-2240(BL)	XISTOR, NPN R
562	Q405	5613-2603(F)or(E)	XISTOR, NPN R
562	Q406	5613-2603(F)or(E)	XISTOR, NPN R
562	Q407	5613-2603(F)or(E)	XISTOR, NPN R
562	Q408	5613-2603(F)or(E)	XISTOR, NPN R
563	Q409	5611-970(BL)	XISTOR, PNP R
563	Q410	5611-970(BL)	XISTOR, PNP R
573	Q411	5613-2240(BL)	XISTOR, NPN R
573	Q412	5613-2240(BL)	XISTOR, NPN R
573	Q413	5613-2240(BL)	XISTOR, NPN R
573	Q414	5613-2240(BL)	XISTOR, NPN R
563	Q415	5611-970(BL)	XISTOR, PNP R
563	Q416	5611-970(BL)	XISTOR, PNP R
564	Q417	5612-646A(C)	XISTOR, PNP A
564	Q418	5612-646A(C)	XISTOR, PNP A
565	Q419	5614-666A(C)	XISTOR, NPN A
565	Q420	5614-666A(C)	XISTOR, NPN A
564	Q421	5612-646A(C)	XISTOR, PNP A
564	Q422	5612-646A(C)	XISTOR, PNP A
565	Q423	5614-666A(C)	XISTOR, NPN A
565	Q424	5614-666A(C)	XISTOR, NPN A

Ser. No.	Ref. No.	Part No.	Description
566	Q425	5613-945(K)or(P)	XISTOR, NPN R
566	Q426	5613-945(K)or(P)	XISTOR, NPN R
567	Q427	5614-669A(C)	XISTOR, NPN A
567	Q428	5614-669A(C)	XISTOR, NPN A
568	Q429	5612-649A(C)	XISTOR, PNP A
568	Q430	5612-649A(C)	XISTOR, PNP A
569	Q431	5613-3182(O)or(R)	XISTOR, NPN R
569	Q432	5613-3182(O)or(R)	XISTOR, NPN R
571	Q433	5611-1265(O)or(R)	XISTOR, PNP R
571	Q434	5611-1265(O)or(R)	XISTOR, PNP R

DIODES

681	ΔD1	5632-ERC102FL	DIODE, RECT
681	ΔD2	5632-ERC102FL	DIODE, RECT
681	ΔD3	5632-ERC102FL	DIODE, RECT
681	ΔD4	5632-ERC102FL	DIODE, RECT
656	D5	5636-1S247I	DIODE, SWITCH
656	D6	5636-1S247I	DIODE, SWITCH
656	D7	5636-1S247I	DIODE, SWITCH
656	D8	5636-1S247I	DIODE, SWITCH
657	D11	5635-HZ6B-1L	DIODE, ZENER
579	D401	5641-MV12YM	VARISTOR
579	D402	5641-MV12YM	VARISTOR
577	D403	5632-S5566B	DIODE, RECT
577	D404	5632-S5566B	DIODE, RECT
577	D405	5632-S5566B	DIODE, RECT
577	D406	5632-S5566B	DIODE, RECT
575	D407	5631-1S2473	DIODE, DET
575	D408	5631-1S2473	DIODE, DET
576	D409	5635-HZ12B2L	DIODE, ZENER
576	D410	5635-HZ12B2L	DIODE, ZENER

COILS

643	L401	5597-45502	CORE, BEADS
643	L402	5597-45502	CORE, BEADS
643	L403	5597-45502	CORE, BEADS
643	L404	5597-45502	CORE, BEADS
644	L405	5991-7165	SPRING COIL
644	L406	5991-7165	SPRING COIL

CONTROLS

641	VR401	5101-50171920	RES, SEMI FIX 500
641	VR402	5101-50171920	RES, SEMI FIX 500
720	VR501	5113-50399122	RES, V CBN 16 50K
720	VR502	5113-50399122	RES, V CBN 16 50K
714	VR505	5113-10441122	RES, V CBN 16 100K
714	VR506	5113-10441122	RES, V CBN 16 100K
717	VR507	5113-50342122	RES, V CBN 16 50K
717	VR508	5113-50342122	RES, V CBN 16 50K

MISCELLANEOUS

747	LCN2	4163-0140026	CONNECTOR W/W
748	LCN3	4163-0140027	CONNECTOR W/W
749	LCN4	4163-0140024	CONNECTOR W/W
750	LCN5	4163-0140025	CONNECTOR W/W
751	LCN6	4163-0116024	CONNECTOR W/W
751	LCN7	4163-0116024	CONNECTOR W/W
751	LCN8	4163-0116024	CONNECTOR W/W
753	LCN9	4163-0116020	CONNECTOR W/W
756	LCN110	4163-0125021	CONNECTOR W/W
757	LCN111	4163-0125020	CONNECTOR W/W
758	LCN112	4163-0125022	CONNECTOR W/W
759	LCN113	4163-0125023	CONNECTOR W/W
699	CN502	4443-030185	CONNECTOR
699	CN601	4443-030185	CONNECTOR
699	CN803	4443-030185	CONNECTOR
764	JL107	4242-R0203600	JUMPER LEAD
763	JL109	4242-R0103201	JUMPER LEAD
762	JL110	4242-R0104181	JUMPER LEAD
766	JL505	4242-R0207141	JUMPER LEAD
694	TM101	4214-11023	TERMINAL
693	TM102	4214-11013	TERMINAL
646	TM110	4214-11013	TERMINAL

Ser. No.	Ref. No.	Part No.	Description
PCB-2 SPEAKERS P.C.BOARD			
743	TM10	4214-156	TERMINAL

PCB-3 HEADPHONE P.C.BOARD			
736	J1	4451-00159	JACK, 1P
761	JL120	4242-043805	JUMPER LEAD

PCB-4 LED P.C.BOARD			
CAPACITORS			
051D	C31	5345-106C0356	CAP, MINI ELE 10μ/16V
051D	C32	5345-106C0356	CAP, MINI ELE 10μ/16V
DIODES			
741	D9	5637-SLP965B5	LED
741	D10	5637-SLP965B5	LED

PCB-5 SPEAKER SWITCH P.C.BOARD			
RESISTORS			
634	R497	5171-471571	RES, MTL 1 470
634	R498	5171-471571	RES, MTL 1 470
MISCELLANEOUS			
765	JL108	4242-R0103101	JUMPER LEAD
729	SW5	4411-00301104	SWITCH, ROTARY

PCB-6 VR P.C.BOARD			
RESISTORS			
629	R503	5135-472522	RES, CBN 1/2P 4.7K
629	R504	5135-472522	RES, CBN 1/2P 4.7K
CONTROLS			
711	VR503	5113-10419122	RES, V CBN 16 100K
711	VR504	5113-10419122	RES, V CBN 16 100K

PCB-7 POWER SWITCH P.C.BOARD			
CAPACITORS			
688	ΔC1	5361-1030419	CAP, CER .01μ
688B	ΔC1	5352-1030958	CAP, MTL .01μ
688D	ΔC1	5352-1030961	CAP, MTL .01μ
RESISTORS			
054B	ΔR1	5135-335522	RES, CBN 1/2P 3.3M
MISCELLANEOUS			
684	ΔHF1	4472-0131	HOLDER, FUSE
684	ΔHF2	4472-0131	HOLDER, FUSE
732	ΔSW1	4431-A01716	SWITCH, PUSH
696	TM1	4214-122	TERMINAL
696	TM2	4214-122	TERMINAL
696	TM3	4214-122	TERMINAL

PCB-8 FUNCTION P.C.BOARD			
CAPACITORS			
059B	C633	5359-1215851	CAP, PPP 120p
059B	C634	5359-1215851	CAP, PPP 120p
058B	C640	5361-1032F	CAP, CER .01μ
DIODES			
838	D802	5631-ISS133	DIODE, DET
838	D803	5631-ISS133	DIODE, DET
MISCELLANEOUS			
737	J2	4484-46	PIN JACK, 4P
737D	J2	4484-49	PIN JACK, 4P
738	J3	4484-46	PIN JACK, 4P

Ser. No.	Ref. No.	Part No.	Description
738D	J3	4484-50	PIN JACK, 4P
738	J4	4484-46	PIN JACK, 4P
738D	J4	4484-50	PIN JACK, 4P
738	J5	4484-46	PIN JACK, 4P
738D	J5	4484-50	PIN JACK, 4P
739	J6	4486-15	PIN JACK, 6P
739D	J6	4486-18	PIN JACK, 6P
755	LCN10	4163-0108020	CONNECTOR W/W
700	CN109	4443-030185	CONNECTOR
700	CN501	4443-030185	CONNECTOR
701	CN801	4443-060185	CONNECTOR
723	SW3	4411-00203104	SWITCH, ROTARY
726	SW4	4411-00205304	SWITCH, ROTARY

PCB-9 BASS CONTROL P.C.BOARD			
CAPACITORS			
806	C521	5345-104F0951	CAP, MINI ELE .1μ/50V
806	C522	5345-104F0951	CAP, MINI ELE .1μ/50V
810	C523	5354-154593	CAP, MYL .15μ
810	C524	5354-154593	CAP, MYL .15μ
808	C525	5345-107D041	CAP, MINI ELE 100μ/25V
808	C526	5345-107D041	CAP, MINI ELE 100μ/25V
811	C527	5354-334593	CAP, MYL .33μ
811	C528	5354-334593	CAP, MYL .33μ
807	C529	5345-224F0951	CAP, MINI ELE .22μ/50V
807	C530	5345-224F0951	CAP, MINI ELE .22μ/50V
812	C563	5354-474593	CAP, MYL .47μ
812	C564	5354-474593	CAP, MYL .47μ
809	C581	5345-227D041	CAP, MINI ELE 220μ/25V
809	C582	5345-227D041	CAP, MINI ELE 220μ/25V
809	C583	5345-227D041	CAP, MINI ELE 220μ/25V
809	C584	5345-227D041	CAP, MINI ELE 220μ/25V
RESISTORS			
814	R521	5135-471522	RES, CBN 1/2P 470
814	R522	5135-471522	RES, CBN 1/2P 470
815	R525	5135-684522	RES, CBN 1/2P 680K
815	R526	5135-684522	RES, CBN 1/2P 680K
816	R527	5135-224522	RES, CBN 1/2P 220K
816	R528	5135-224522	RES, CBN 1/2P 220K
817	R529	5135-332522	RES, CBN 1/2P 3.3K
817	R530	5135-332522	RES, CBN 1/2P 3.3K
817	R531	5135-332522	RES, CBN 1/2P 3.3K
817	R532	5135-332522	RES, CBN 1/2P 3.3K
818	R533	5135-183522	RES, CBN 1/2P 18K
818	R534	5135-183522	RES, CBN 1/2P 18K
819	R535	5135-472522	RES, CBN 1/2P 4.7K
819	R536	5135-472522	RES, CBN 1/2P 4.7K
820	R537	5135-562522	RES, CBN 1/2P 5.6K
820	R538	5135-562522	RES, CBN 1/2P 5.6K
817	R539	5135-332522	RES, CBN 1/2P 3.3K
817	R540	5135-332522	RES, CBN 1/2P 3.3K
817	R541	5135-332522	RES, CBN 1/2P 3.3K
817	R542	5135-332522	RES, CBN 1/2P 3.3K
818	R543	5135-183522	RES, CBN 1/2P 18K
818	R544	5135-183522	RES, CBN 1/2P 18K
821	R545	5135-331522	RES, CBN 1/2P 330
821	R546	5135-331522	RES, CBN 1/2P 330
823	R547	5135-221522	RES, CBN 1/2P 220
823	R548	5135-221522	RES, CBN 1/2P 220
821	R549	5135-331522	RES, CBN 1/2P 330
821	R550	5135-331522	RES, CBN 1/2P 330
822	R551	5135-104522	RES, CBN 1/2P 100K
822	R552	5135-104522	RES, CBN 1/2P 100K
828	R553	5135-153522	RES, CBN 1/2P 15K
830	ΔR554	5102-8214715	RES, FUSE 820
828	R556	5135-153522	RES, CBN 1/2P 15K
830	ΔR557	5102-8214715	RES, FUSE 820

TRANSISTORS			
801	Q501	5613-2603(F)or(E)	XISTOR, NPN R
801	Q502	5613-2603(F)or(E)	XISTOR, NPN R

Ser. No.	Ref. No.	Part No.	Description
802	Q503	5611-1115(F)or(E)	XISTOR, PNP R
802	Q504	5611-1115(F)or(E)	XISTOR, PNP R
801	Q505	5613-2603(F)or(E)	XISTOR, NPN R
801	Q506	5613-2603(F)or(E)	XISTOR, NPN R
804	Q507	5612-647(C)	XISTOR, PNP A
803	Q508	5614-667(C)	XISTOR, NPN A
DIODES			
805	D501	5635-HZ12B2L	DIODE, ZENER
805	D502	5635-HZ12B2L	DIODE, ZENER
MISCELLANEOUS			
754	LCN501	4163-0116020	CONNECTOR W/W
702	CN503	4443-030185	CONNECTOR
702	CN504	4443-030185	CONNECTOR
703	CN505	4443-070185	CONNECTOR
767	JL501	4242-R0203800	JUMPER LEAD
767	JL502	4242-R0203800	JUMPER LEAD
731	SW6	4431-04127170	SWITCH, PUSH

PCB-10 VIDEO P.C.BOARD

CAPACITORS

842	C801	5345-107B041	CAP, MINI ELE 100μ/10V
842	C802	5345-107B041	CAP, MINI ELE 100μ/10V
842	C803	5345-107B041	CAP, MINI ELE 100μ/10V
843	C804	5345-106C041	CAP, MINI ELE 10μ/16V
840	C805	5345-337B041	CAP, MINI ELE 330μ/10V
840	C806	5345-337B041	CAP, MINI ELE 330μ/10V
840	C807	5345-337B041	CAP, MINI ELE 330μ/10V
841	C808	5345-227C041	CAP, MINI ELE 220μ/16V
841	C809	5345-227C041	CAP, MINI ELE 220μ/16V

RESISTORS

847	R801	5232-122J16P	RES, CBN 1/6P 1.2K
848	R802	5232-750J16P	RES, CBN 1/6P 75
849	R803	5232-331J16P	RES, CBN 1/6P 330
850	R804	5232-393J16P	RES, CBN 1/6P 39K
850	R805	5232-393J16P	RES, CBN 1/6P 39K
848	R806	5232-750J16P	RES, CBN 1/6P 75
849	R807	5232-331J16P	RES, CBN 1/6P 330
850	R808	5232-393J16P	RES, CBN 1/6P 39K
850	R809	5232-393J16P	RES, CBN 1/6P 39K
848	R810	5232-750J16P	RES, CBN 1/6P 75
849	R811	5232-331J16P	RES, CBN 1/6P 330
850	R812	5232-393J16P	RES, CBN 1/6P 39K
850	R813	5232-393J16P	RES, CBN 1/6P 39K
851	R814	5232-221J16P	RES, CBN 1/6P 220
852	R815	5232-271J16P	RES, CBN 1/6P 270
848	R816	5232-750J16P	RES, CBN 1/6P 75
851	R817	5232-221J16P	RES, CBN 1/6P 220
851	R818	5232-221J16P	RES, CBN 1/6P 220
852	R819	5232-271J16P	RES, CBN 1/6P 270
848	R820	5232-750J16P	RES, CBN 1/6P 75
851	R821	5232-221J16P	RES, CBN 1/6P 220
851	R822	5232-221J16P	RES, CBN 1/6P 220
852	R823	5232-271J16P	RES, CBN 1/6P 270
848	R824	5232-750J16P	RES, CBN 1/6P 75
853	R825	5232-272J16P	RES, CBN 1/6P 2.7K
856	R826	5171-S010J221	RES, MTL I 220
858	△R827	5102-5604715	RES, FUSE 56
855	R829	5135-153522	RES, CBN 1/2P 15K
851	R830	5232-221J16P	RES, CBN 1/6P 220

INTEGRATED CIRCUITS

831	IC801	5654-TC4066BP	IC, DIGITAL
831	IC802	5654-TC4066BP	IC, DIGITAL

TRANSISTORS

833	Q801	5613-2603(F)or(E)	XISTOR, NPN R
835	Q802	5611-1115(F)or(E)	XISTOR, PNP R
833	Q803	5613-2603(F)or(E)	XISTOR, NPN R
835	Q804	5611-1115(F)or(E)	XISTOR, PNP R
833	Q805	5613-2603(F)or(E)	XISTOR, NPN R
835	Q806	5611-1115(F)or(E)	XISTOR, PNP R

Ser. No.	Ref. No.	Part No.	Description
DIODE			
837	D801	5635-HZ12B2L	DIODE, ZENER
MISCELLANEOUS			
740	J7	4489-00101002	PIN JACK, MLT
740D	J7	4489-00102002	PIN JACK, MLT
740	J8	4489-00101002	PIN JACK, MLT
740D	J8	4489-00102002	PIN JACK, MLT
740	J9	4489-00101002	PIN JACK, MLT
740D	J9	4489-00102002	PIN JACK, MLT
770	JL801	4242-R0206141	JUMPER LEAD
768	JL802	4242-R0103221	JUMPER LEAD
769	JL803	4242-R0203181	JUMPER LEAD
845	RC801	5212-473J0501	R COMPOSITE

PCB-11 EQUALIZER P.C.BOARD

CAPACITORS

509	C601	5345-336C0951	CAP, MINI ELE 33μ/16V
509	C602	5345-336C0951	CAP, MINI ELE 33μ/16V
513	C603	5359-1215851	CAP, PPP 120p
513	C604	5359-1215851	CAP, PPP 120p
510	C605	5345-107B0951	CAP, MINI ELE 100μ/10V
510	C606	5345-107B0951	CAP, MINI ELE 100μ/10V
514	C607	5359-5625851	CAP, PPP 5600p
514	C608	5359-5625851	CAP, PPP 5600p
515	C609	5359-2025851	CAP, PPP 2000p
515	C610	5359-2025851	CAP, PPP 2000p
511	C611	5345-106C0951	CAP, MINI ELE 10μ/16V
511	C612	5345-106C0951	CAP, MINI ELE 10μ/16V
512	C613	5345-227D041	CAP, MINI ELE 220μ/25V
512	C614	5345-227D041	CAP, MINI ELE 220μ/25V
512	C615	5345-227D041	CAP, MINI ELE 220μ/25V
512	C616	5345-227D041	CAP, MINI ELE 220μ/25V
546	C617	5345-106C0951	CAP, MINI ELE 10μ/16V
546	C618	5345-106C0951	CAP, MINI ELE 10μ/16V
547	C619	5345-107B0951	CAP, MINI ELE 100μ/10V
547	C620	5345-107B0951	CAP, MINI ELE 100μ/10V
547	C621	5345-107B0951	CAP, MINI ELE 100μ/10V
547	C622	5345-107B0951	CAP, MINI ELE 100μ/10V
548	C623	5345-107C041	CAP, MINI ELE 100μ/16V
548	C624	5345-107C041	CAP, MINI ELE 100μ/16V
056B	C631	5353-820534	CAP, MCA 82p
056B	C632	5353-820534	CAP, MCA 82p
060B	C635	5359-1025851	CAP, PPP 1000p
060B	C636	5359-1025851	CAP, PPP 1000p
061B	C637	5354-473593	CAP, MYL .047μ
061B	C638	5354-473593	CAP, MYL .047μ

RESISTORS

517	R601	5232-823J16P	RES, CBN 1/6P 82K
517	R602	5232-823J16P	RES, CBN 1/6P 82K
518	R603	5232-124J16P	RES, CBN 1/6P 120K
518	R604	5232-124J16P	RES, CBN 1/6P 120K
519	R605	5232-221J16P	RES, CBN 1/6P 220
519	R606	5232-221J16P	RES, CBN 1/6P 220
520	R607	5232-392J16P	RES, CBN 1/6P 3.9K
520	R608	5232-392J16P	RES, CBN 1/6P 3.9K
521	R609	5232-681J16P	RES, CBN 1/6P 680
521	R610	5232-681J16P	RES, CBN 1/6P 680
522	R611	5232-122J16P	RES, CBN 1/6P 1.2K
522	R612	5232-122J16P	RES, CBN 1/6P 1.2K
523	R613	5232-223J16P	RES, CBN 1/6P 22K
523	R614	5232-223J16P	RES, CBN 1/6P 22K
519	R615	5232-221J16P	RES, CBN 1/6P 220
519	R616	5232-221J16P	RES, CBN 1/6P 220
524	R617	5232-101J16P	RES, CBN 1/6P 100
524	R618	5232-101J16P	RES, CBN 1/6P 100
525	R621	5232-751J16P	RES, CBN 1/6P 750
525	R622	5232-751J16P	RES, CBN 1/6P 750
526	R623	5232-393J16P	RES, CBN 1/6P 39K
526	R624	5232-393J16P	RES, CBN 1/6P 39K
527	R625	5232-684J16P	RES, CBN 1/6P 680K

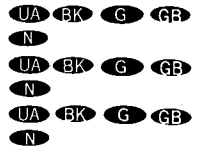

Ser. No.	Ref. No.	Part No.	Description
527	R626	5232-684J16P	RES, CBN 1/6P 680K
528	R627	5232-334J16P	RES, CBN 1/6P 330K
528	R628	5232-334J16P	RES, CBN 1/6P 330K
529	R629	5232-102J16P	RES, CBN 1/6P 1K
529	R630	5232-102J16P	RES, CBN 1/6P 1K
530	R631	5232-104J16P	RES, CBN 1/6P 100K
530	R632	5232-104J16P	RES, CBN 1/6P 100K
519	R633	5232-221J16P	RES, CBN 1/6P 220
519	R634	5232-221J16P	RES, CBN 1/6P 220
531	R635	5232-222J16P	RES, CBN 1/6P 2.2K
531	R636	5232-222J16P	RES, CBN 1/6P 2.2K
538	△R637	5102-6804715	RES, FUSE 68
536	R638	5171-S010J27I	RES, MTL 1 270
533	R639	5135-123522	RES, CBN 1/2P 12K
534	R640	5135-153522	RES, CBN 1/2P 15K
535	R641	5176-S010J39I	RES, MTL 1/2 390
539	△R642	5102-1814715	RES, FUSE 180
550	R643	5232-822J16P	RES, CBN 1/6P 8.2K
550	R644	5232-822J16P	RES, CBN 1/6P 8.2K
551	R645	5232-1R0J16P	RES, CBN 1/6P 1
551B	R645	5232-100J16P	RES, CBN 1/6P 10
551	R646	5232-1R0J16P	RES, CBN 1/6P 1
551B	R646	5232-100J16P	RES, CBN 1/6P 10
552	R647	5232-121J16P	RES, CBN 1/6P 120
552	R648	5232-121J16P	RES, CBN 1/6P 120
553	R649	5232-220J16P	RES, CBN 1/6P 22
553	R650	5232-220J16P	RES, CBN 1/6P 22
554	R651	5232-560J16P	RES, CBN 1/6P 56
554B	R651	5232-470J16P	RES, CBN 1/6P 47
554	R652	5232-560J16P	RES, CBN 1/6P 56
554B	R652	5232-470J16P	RES, CBN 1/6P 47
555	R653	5232-272J16P	RES, CBN 1/6P 2.7K
555	R654	5232-272J16P	RES, CBN 1/6P 2.7K
552	R655	5232-121J16P	RES, CBN 1/6P 120
552	R656	5232-121J16P	RES, CBN 1/6P 120
556	R657	5232-681J16P	RES, CBN 1/6P 680
556	R658	5232-681J16P	RES, CBN 1/6P 680
557	R659	5232-562J16P	RES, CBN 1/6P 5.6K
557	R660	5232-562J16P	RES, CBN 1/6P 5.6K
559	R661	5135-152522	RES, CBN 1/2P 1.5K
055B	R671	5232-102J16P	RES, CBN 1/6P 1K
055B	R672	5232-102J16P	RES, CBN 1/6P 1K
055B	R673	5232-102J16P	RES, CBN 1/6P 1K
055B	R674	5232-102J16P	RES, CBN 1/6P 1K

TRANSISTORS

501	Q601	5613-2320L(F)	XISTOR, NPN R
501	Q602	5613-2320L(F)	XISTOR, NPN R
504	Q603	5611-999L(F)	XISTOR, PNP R
504	Q604	5611-999L(F)	XISTOR, PNP R
505	Q605	5611-1115(F)or(E)	XISTOR, PNP R
505	Q606	5611-1115(F)or(E)	XISTOR, PNP R
502	Q607	5613-2603(F)or(E)	XISTOR, NPN R
502	Q608	5613-2603(F)or(E)	XISTOR, NPN R
502	Q609	5613-2603(F)or(E)	XISTOR, NPN R
502	Q610	5613-2603(F)or(E)	XISTOR, NPN R
502	Q611	5613-2603(F)or(E)	XISTOR, NPN R
502	Q612	5613-2603(F)or(E)	XISTOR, NPN R
503	Q613	5613-3422(Y)or(O)	XISTOR, NPN R
506	Q614	5611-1359(Y)or(O)	XISTOR, PNP R
542	Q615	5613-2855(E)	XISTOR, NPN R
542	Q616	5613-2855(E)	XISTOR, NPN R
542	Q617	5613-2855(E)	XISTOR, NPN R
542	Q618	5613-2855(E)	XISTOR, NPN R
543	Q619	5613-2603(F)or(E)	XISTOR, NPN R

DIODES

507	D601	5635-HZ15-2L	DIODE, ZENER
507	D602	5635-HZ15-2L	DIODE, ZENER
544	D603	5635-HZ12B2L	DIODE, ZENER

COILS

062B	L601	5597-45502	CORE, BEADS
062B	L602	5597-45502	CORE, BEADS
062B	L603	5597-45502	CORE, BEADS
062B	L604	5597-45502	CORE, BEADS

Ser. No.	Ref. No.	Part No.	Description
MISCELLANEOUS			
752	LCN601	4163-0130020	CONNECTOR W/W
705	CN602	4443-047175	CONNECTOR
706	CN603	4443-067175	CONNECTOR
771	JL601	4242-R0203800	JUMPER LEAD
733	SW7	4431-S0302102	SWITCH, PUSH

PCB-12 Q807 P.C. BOARD

CAPACITORS

839	C810	5361-122KB	CAP, CER 1200p
-----	------	------------	----------------

TRANSISTORS

834	Q807	5613-3422(Y)or(O)	XISTOR, NPN R
-----	------	-------------------	---------------

CHASSIS MISCELLANEOUS

052B	△CO1	4443-712	CONNECTOR
685	△F1	5732-402031	FUSE
685B	△F1	5732-202052	FUSE
685D	△F1	5732-502036	FUSE
683	△T1	5584-S11	XFORMER, POWER
683B	△T1	5584-S12	XFORMER, POWER
683D	△T1	5584-S13	XFORMER, POWER
684		4472-0131	HOLDER, FUSE
734	△SW2	4421-0227230	SWITCH, SLIDE
744	△SO1	4474-227	SOCKET
745	△P1	4442-14	CORD W/PLUG
745B	△P1	4161-7256	CORD W/PLUG
745D	△P1	4161-71133	CORD W/PLUG
650	LUG2	4211-4	LUG
746		4442-14	PIN PLUG
051B	△SW101	4411-102729	ROTARY SWITCH

PACKAGE PARTS LIST

021B	1756-06303	LABEL
021D	1756-03113	LABEL
022B	1756-03108	LABEL
023D	1241-PB	POLYETHYLENE BAG
027B	1119-026	ATTACH SHEET
106	1111-J90915	OWNER GUIDE
107	1111-J30269	OWNER GUIDE
107B	1111-J30270	OWNER GUIDE
107D	1111-J2039	OWNER GUIDE
108	1113-717004	OWNER CARD
108D	1113-OC	OWNER CARD
109	1119-047	ATTACH SHEET
109D	1119-GC	ATTACH SHEET
110	1119-0137	ATTACH SHEET
121	1241-C12732	POLYETHYLENE BAG
122	1241-C1491	POLYETHYLENE BAG
124	1221-867144	CARTON BOX
125	1222-7216	CUSHION
127	1223-11729	SOFT SHEET

ABBREVIATIONS IN PARTS LIST

CAPACITORS	RESISTORS
CAP, MINI ELE : Electrolytic	RES, CBN 1/6P : Carbon 1/6W
CAP, CER : Ceramic	RES, FUSE : Fuse
CAP, PPP : Polypropylene	RES, CEM 5P : Cement 5W
CAP, MYL : Mylar	RES, MTL 1P : Metal 1W
CAP, MCA : Mica	2.2K : 2.2kΩ
CAP, MINI BP : Bipolar	220 : 220Ω
CAP, ELE BP : Electrolytic Bipolar	TRANSISTORS
CAP, STY : Polystyrene Film	XISTOR : Transistor
CAP, SPE : Special	FET : Field Effect Transistor
CAP, TAN : Tantalum	CONTROLS
470μ : 470μF	RES, V CBN : Variable Carbon Resistor
6800p : 6800pF	RES, SEMI FIX : Semi-fixed Resistor
.047μ : 0.047μF	

NOTE

SAFETY RELATED COMPONENT. USE ONLY EXACT REPLACEMENT PART AS SPECIFIED.

SCHMATIC DIAGRAM

1
2
3
4
5
6
7

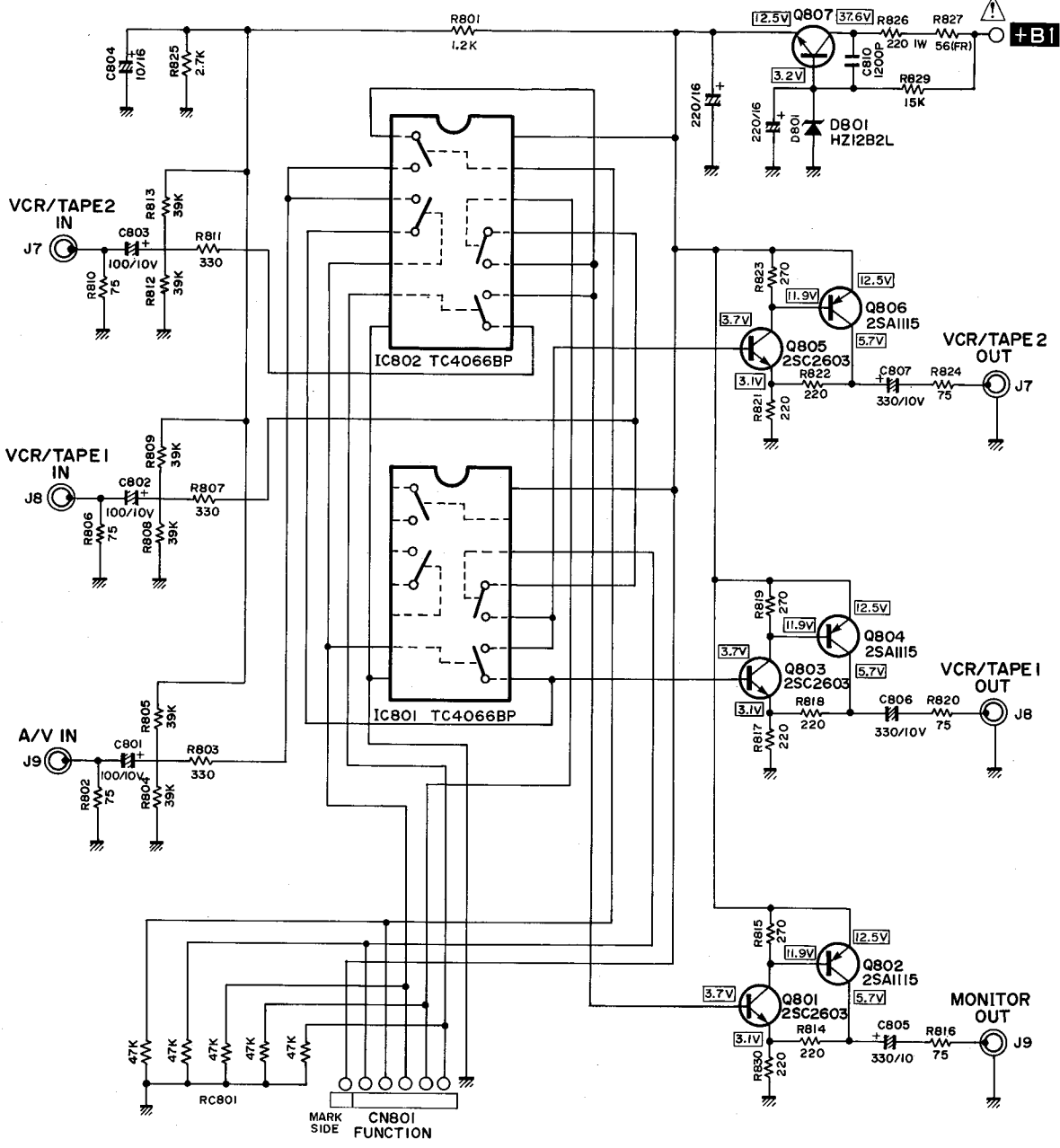

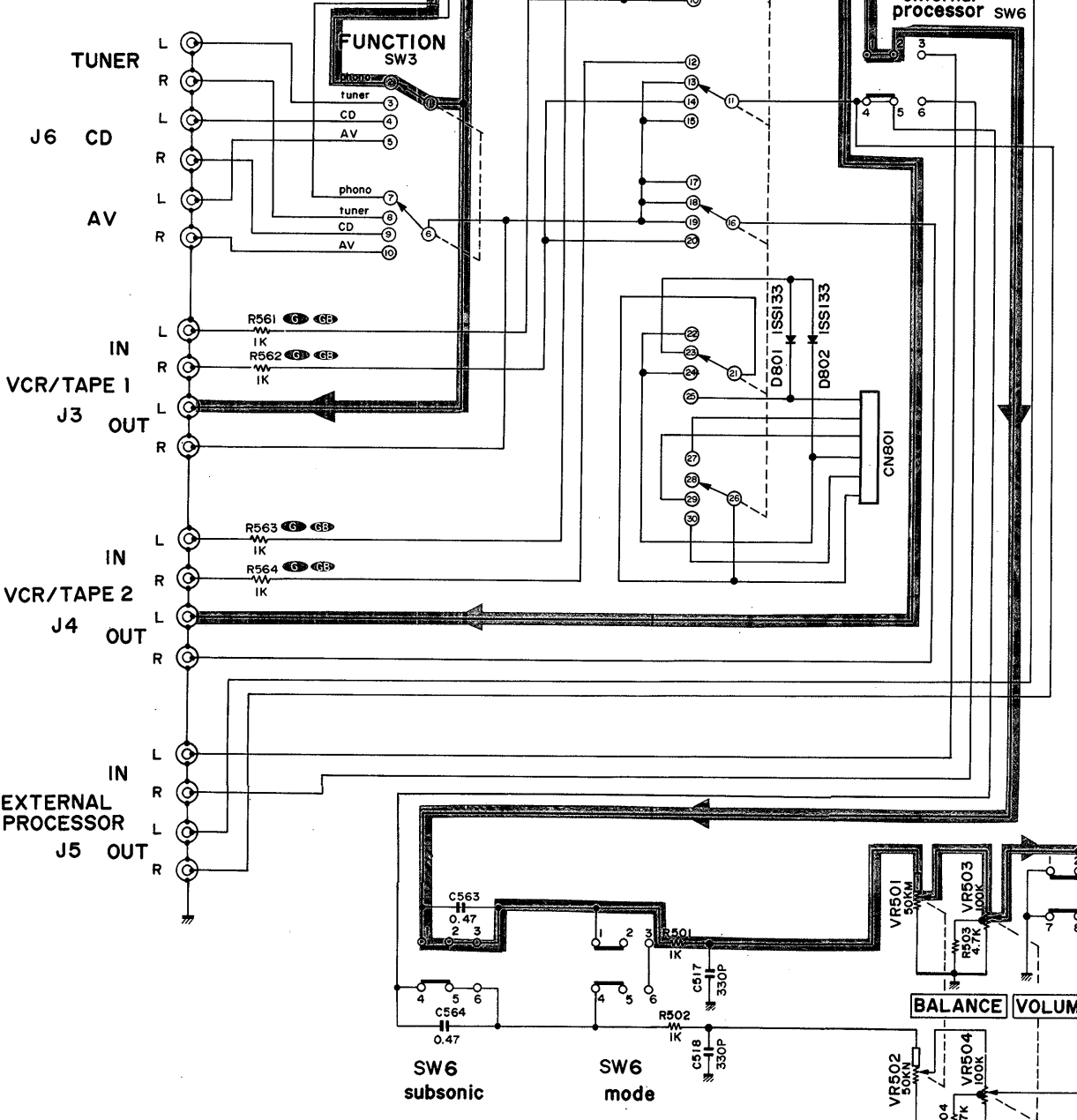
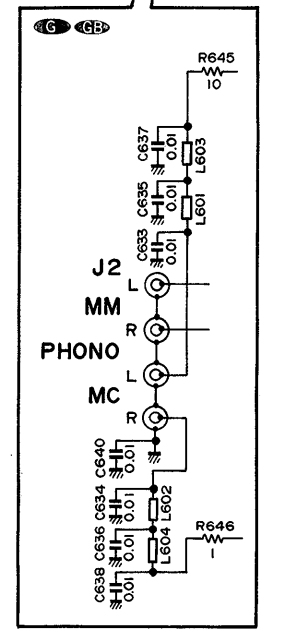
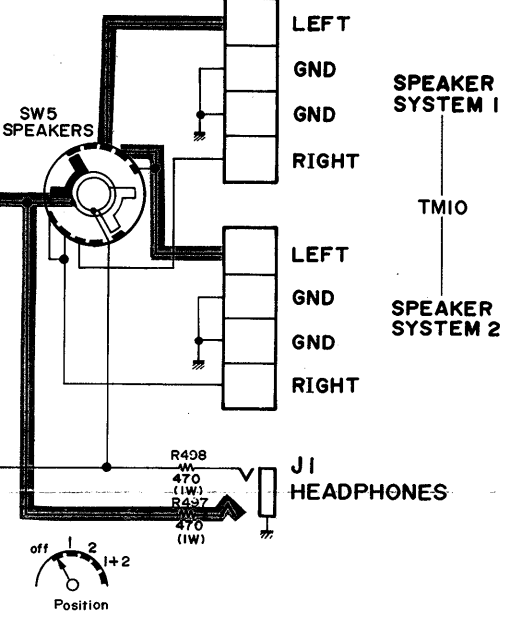
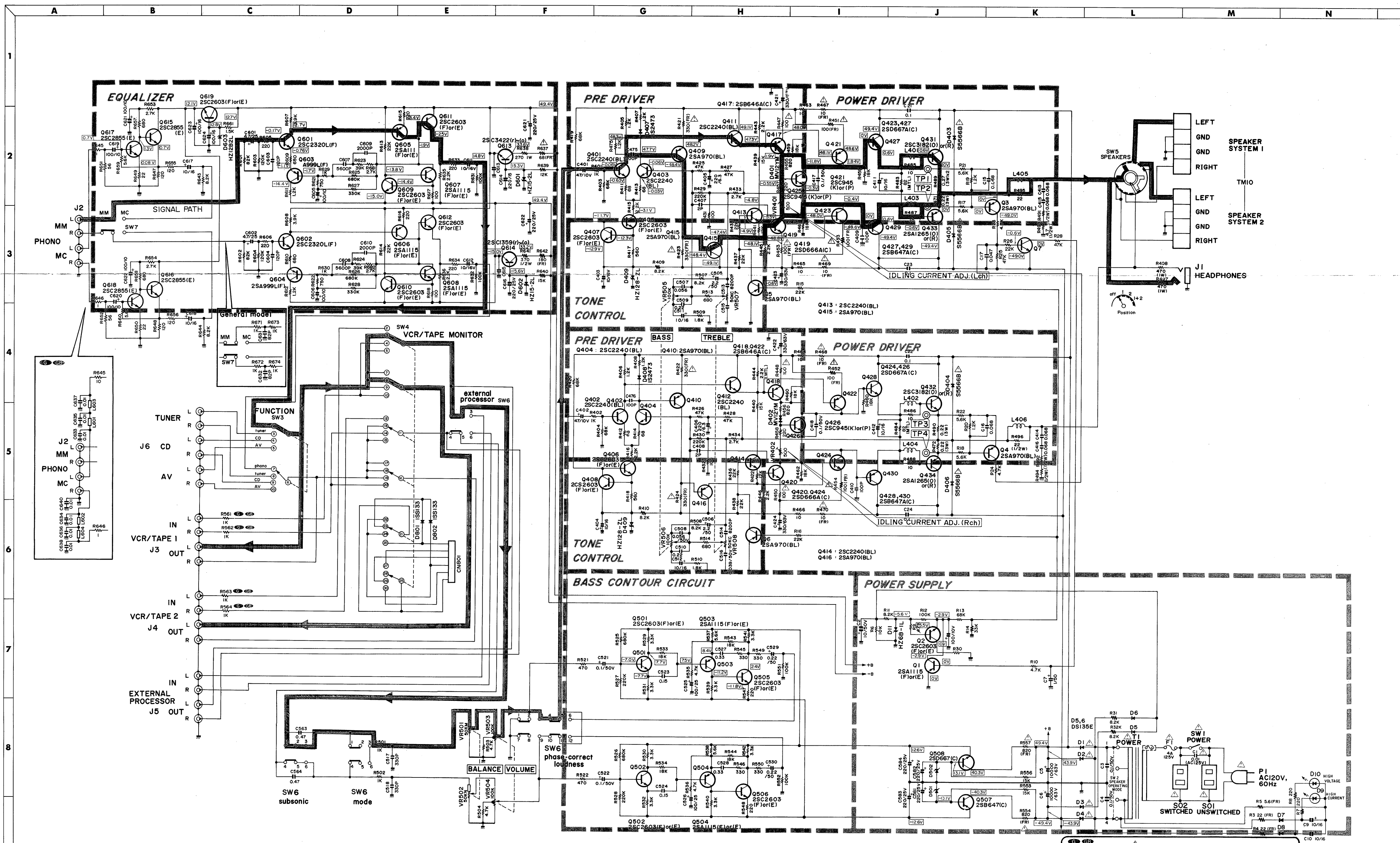

1. ALL RESISTANCES VALUES ARE IN Ω.
KΩ=1000Ω, MΩ=1000KΩ.
2. THE WATTAGE OF RESISTORS IS 1/4W UNLESS OTHERWISE NOTED.
3. ALL CAPACITANCES VALUES ARE IN μF UNLESS OTHERWISE NOTED. P=μF
4. ∇ : DC VOLTAGE AT NO SIGNAL
5. SAFETY REQUIREMENTS COMPONENTS IN ACCORDANCE WITH PRESENT SAFETY REGULATIONS, THESE COMPONENTS MUST ONLY BE REPLACED BY ORIGINAL PARTS.

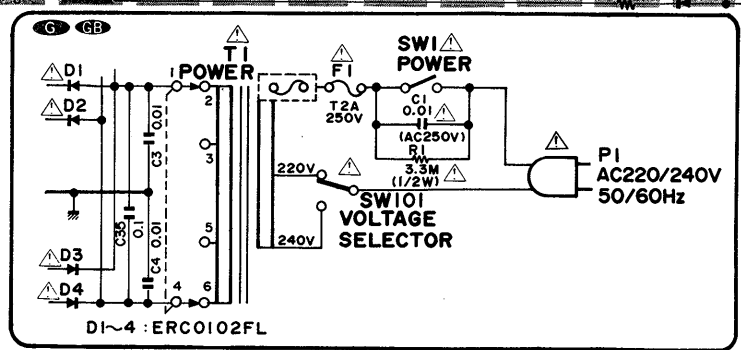

J

K

L

M

N

R DRIVER

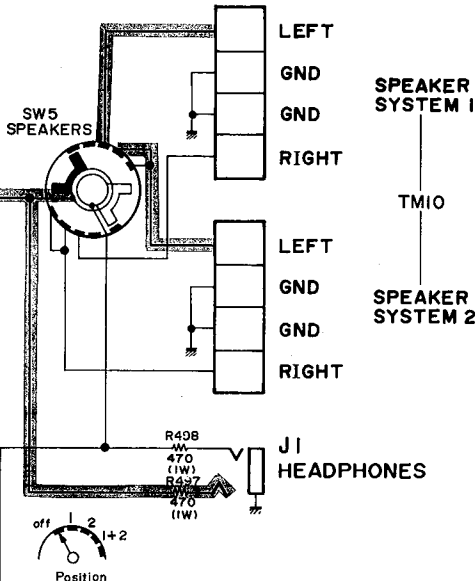
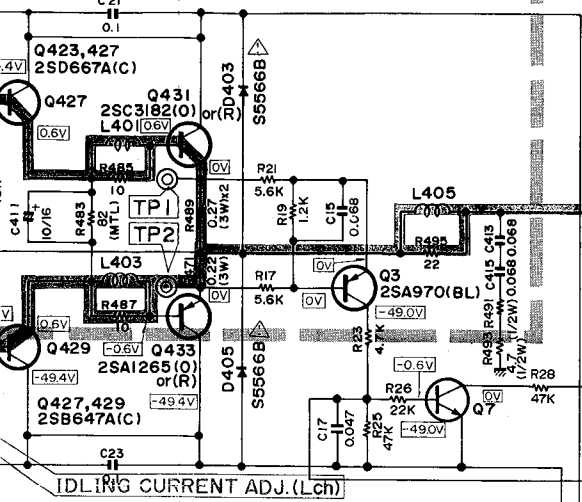

R DRIVER

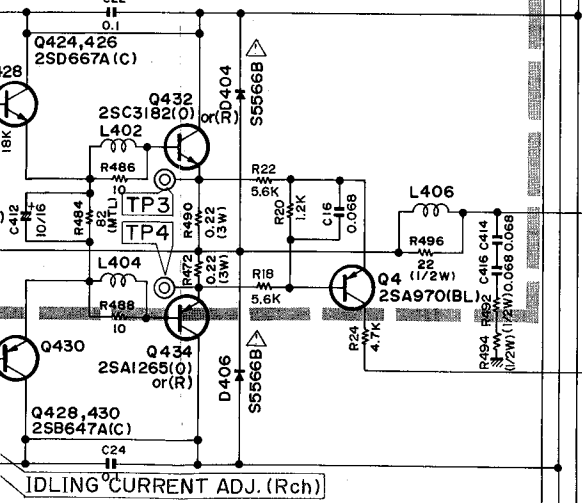

POWER SUPPLY

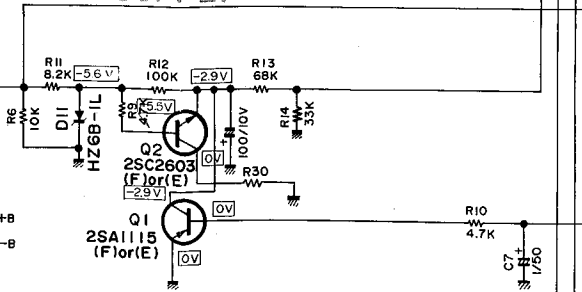

4
5
6
7
8
9
10

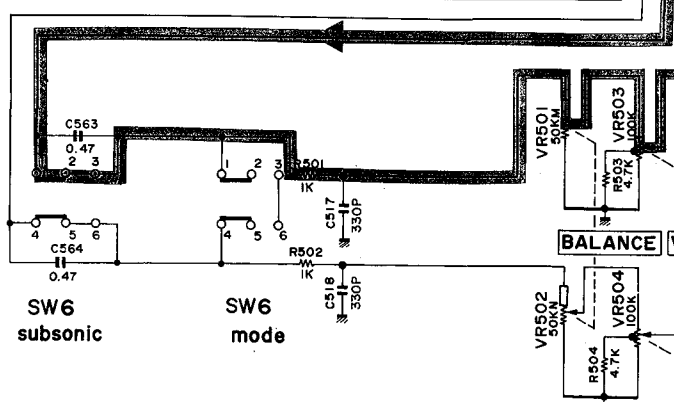
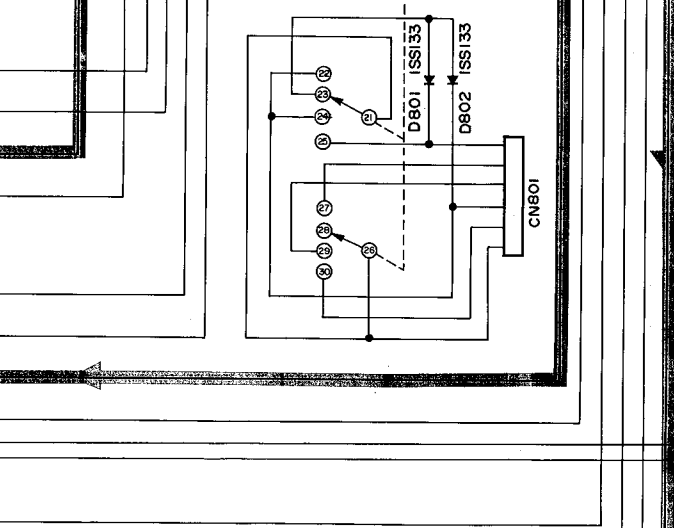
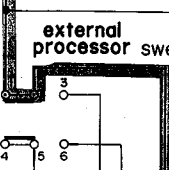
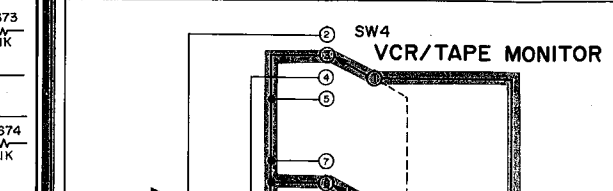
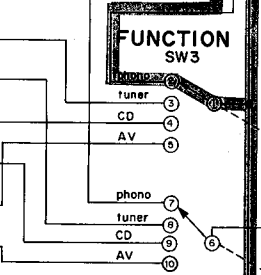
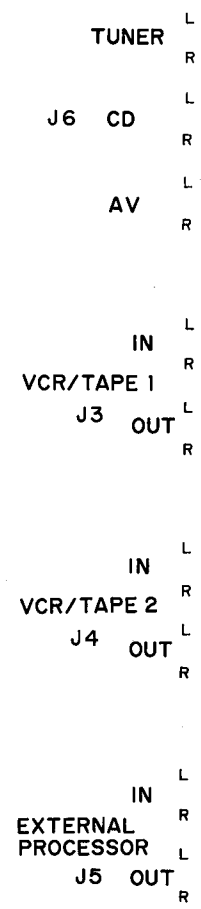
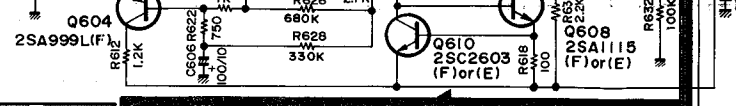
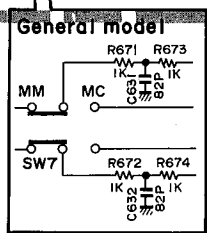
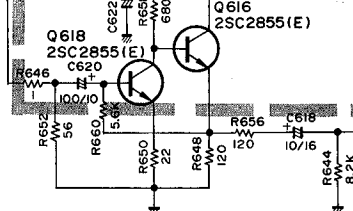
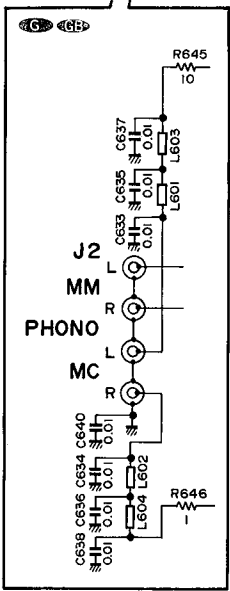

1. A
2. T
3. A
4. [
- 5.

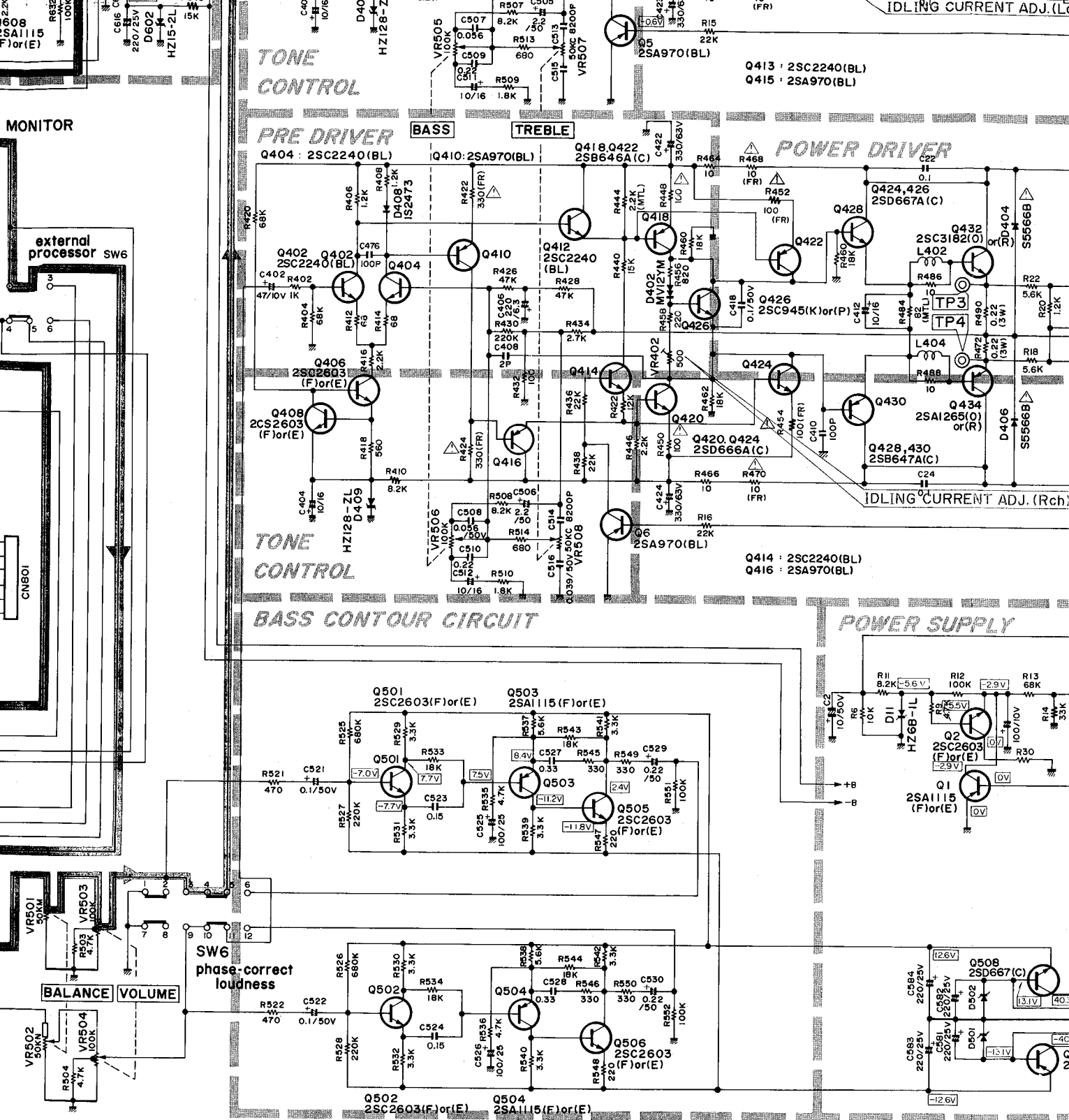

1. ALL RESISTANCES VALUES ARE IN Ω .
K Ω =1000 Ω , M Ω =1000K Ω .
2. THE WATTAGE OF RESISTORS IS 1/4W UNLESS OTHERWISE NOTED.
3. ALL CAPACITANCES VALUES ARE IN μ F UNLESS OTHERWISE NOTED. P= μ MUF
4. \dots V: DC VOLTAGE AT NO SIGNAL
5. SAFETY-REQUIREMENTS COMPONENTS IN ACCORDANCE WITH PRESENT SAFETY REGULATIONS, THESE COMPONENTS MUST ONLY BE REPLACED BY ORIGINAL PARTS.

DLING CURRENT ADJ. (Lch)

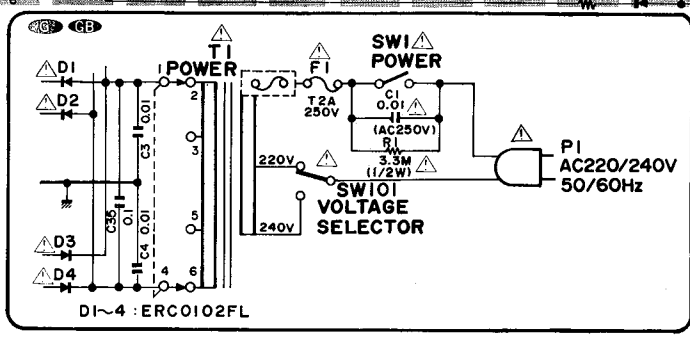
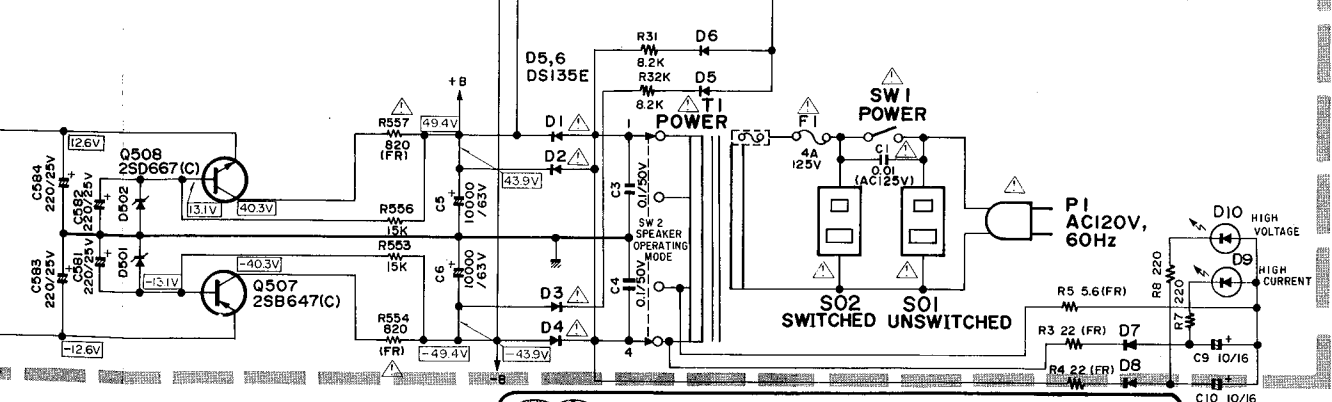
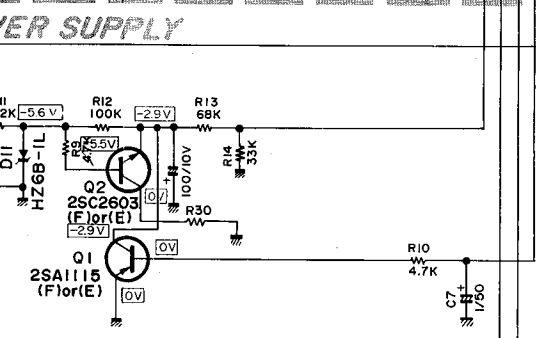
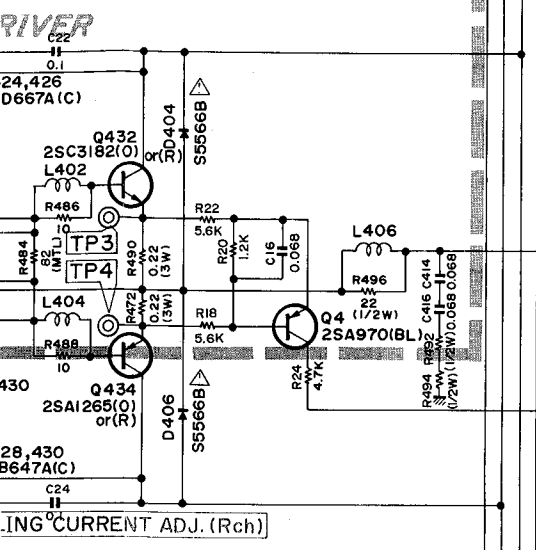
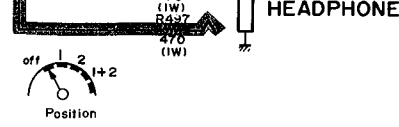

WIRING DIAGRAM

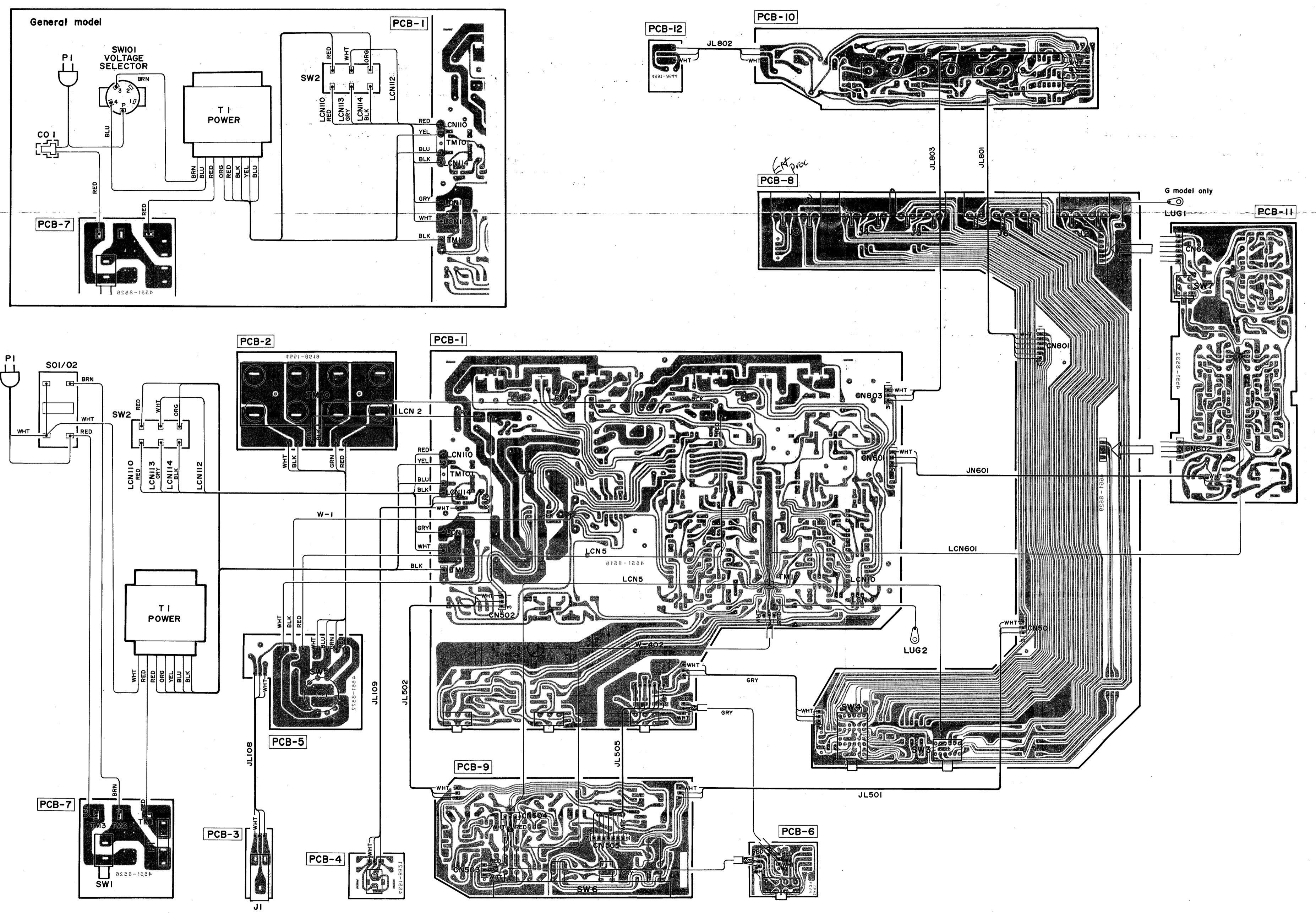

- WIRE COLOR ABBREVIATIONS
- RED : Red YEL : Yellow
- ORG : Orange PUP : Purple
- BLU : Blue PIK : Pink
- WHT : White GRY : Gray
- GRN : Green BRN : Brown
- BLK : Black

A B C D E

1
2
3
4
5
6
7

WIRING DIAGRAM

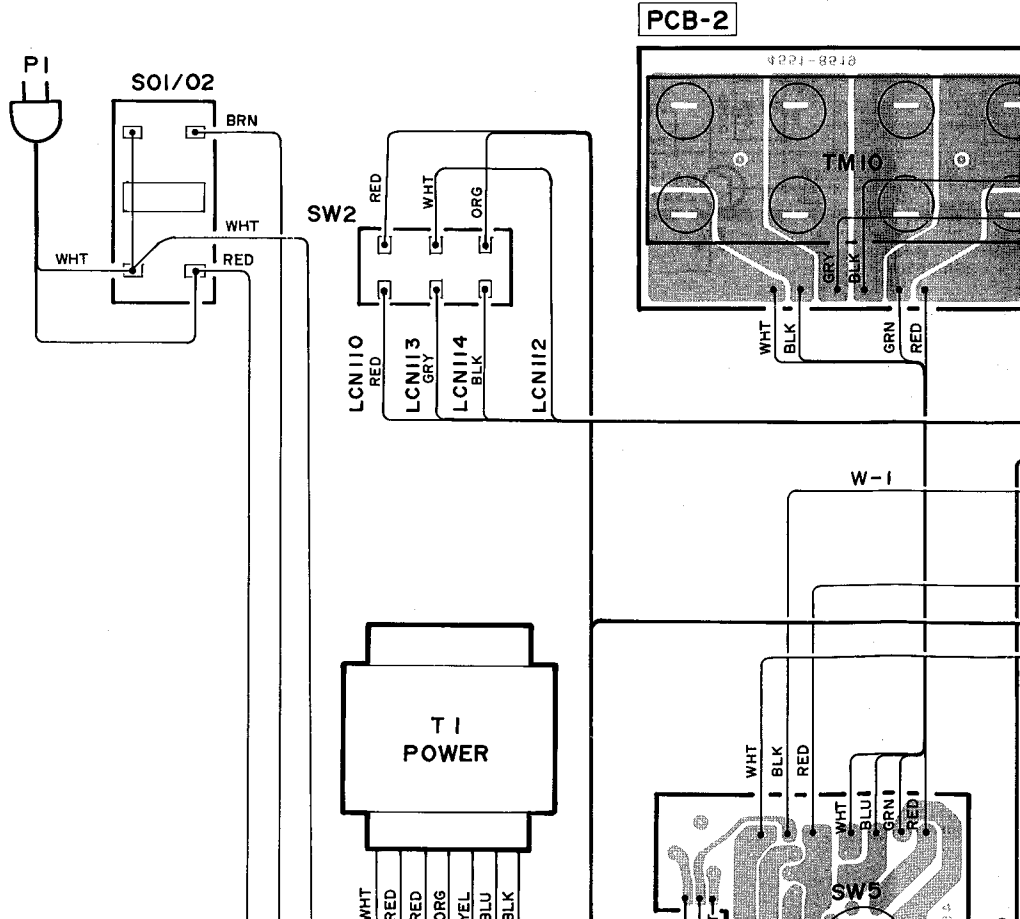
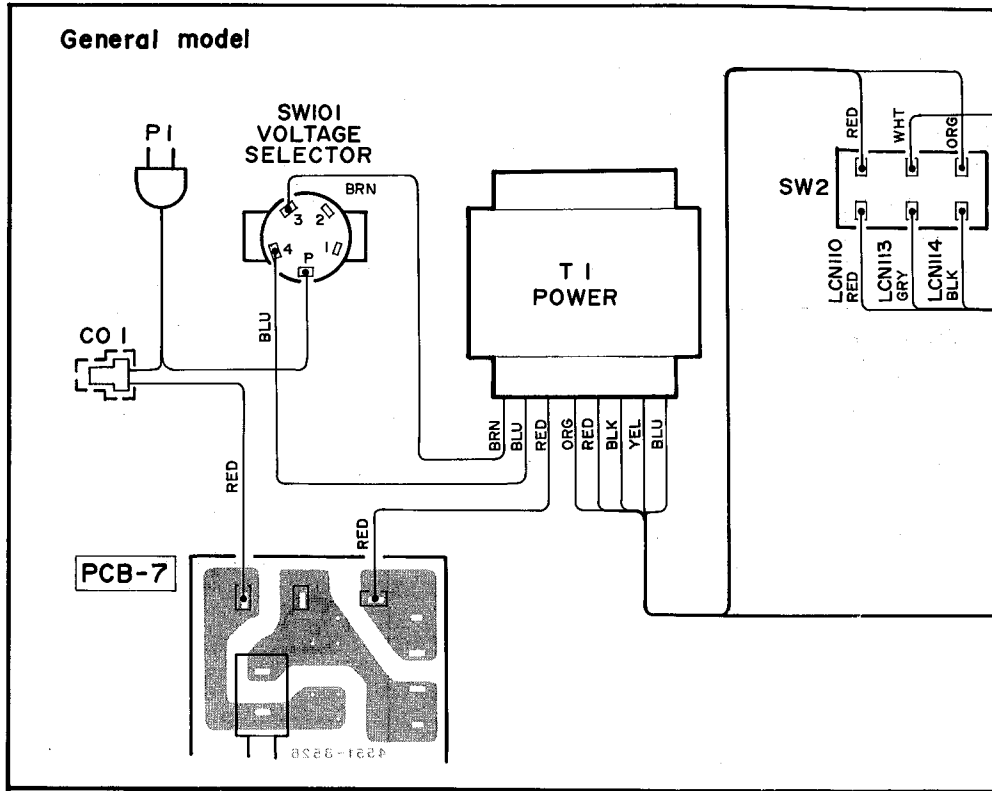

J

K

L

M

N

10

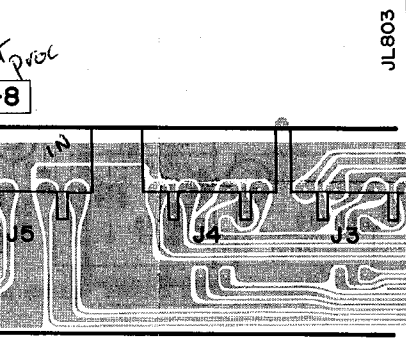
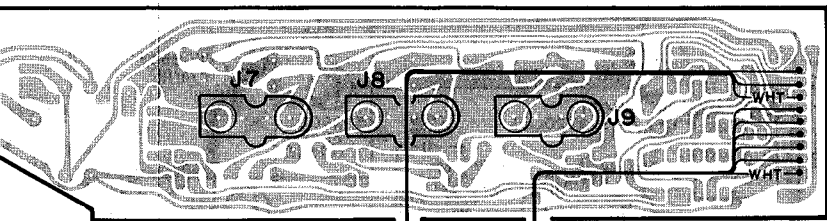

JL803

JL801

G model only

LUG1

PCB-11

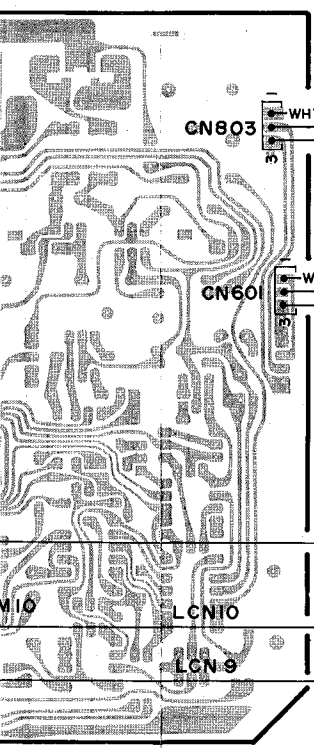

CN803

CN601

LCN10

LCN9

LUG2

JN601

LCN601

CN501

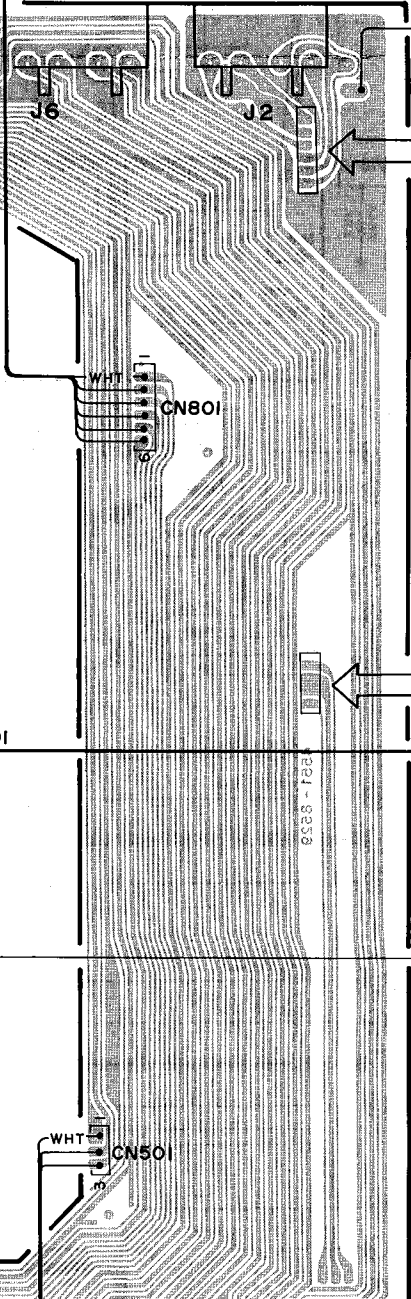

CN801

CN603

SW7

3050-11284

CN602

WHT

204-3050

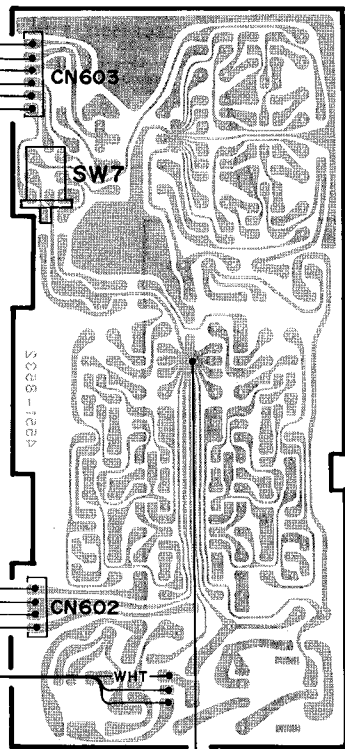

4

5

6

7

8

9

10

PCB-7

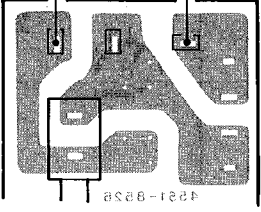

PCB-2

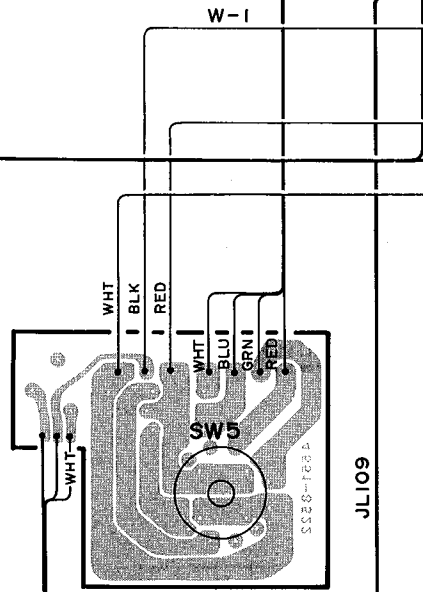
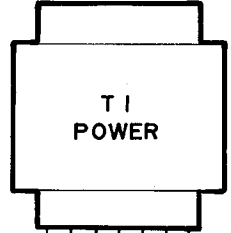
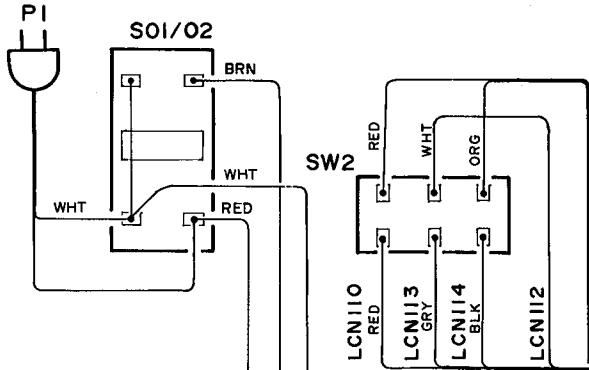
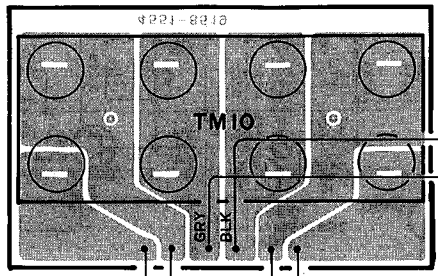

PCB-7

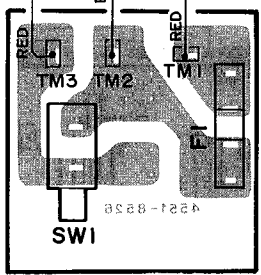

PCB-3

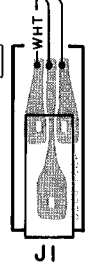

PCB-4

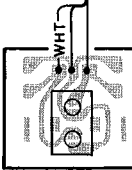

- WIRE COLOR ABBREVIATIONS
- RED : Red YEL : Yellow
- ORG : Orange PUP : Purple
- BLU : Blue PIK : Pink
- WHT : White GRY : Gray
- GRN : Green BRN : Brown
- BLK : Black

WHT → LCN112

BLK → TM102

PCB-1

LCN 2

LCN 4

BLK

CN803

RED → LCN110

YEL → TM101

BLU → LCN114

BLK → LCN114

WHT → LCN3

GRY → LCN113

WHT → LCN112

BLK → TM102

LCN5

8128-1224

LCN5

TM10

LCN10

LCN9

WHT → CN502

W-402

GRY

WHT

GRY

RED

WHT

GRY

JL109

JL502

JL505

PCB-9

WHT

WHT

CN504

CN505

CN503

SW6

PCB-6

RED

WHT

JL501

SW4

4

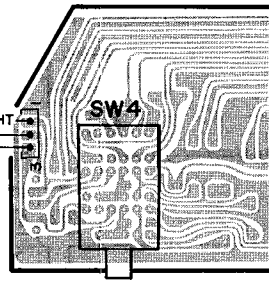
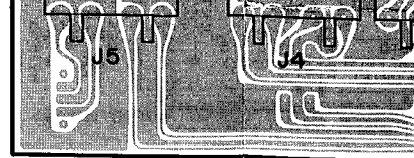
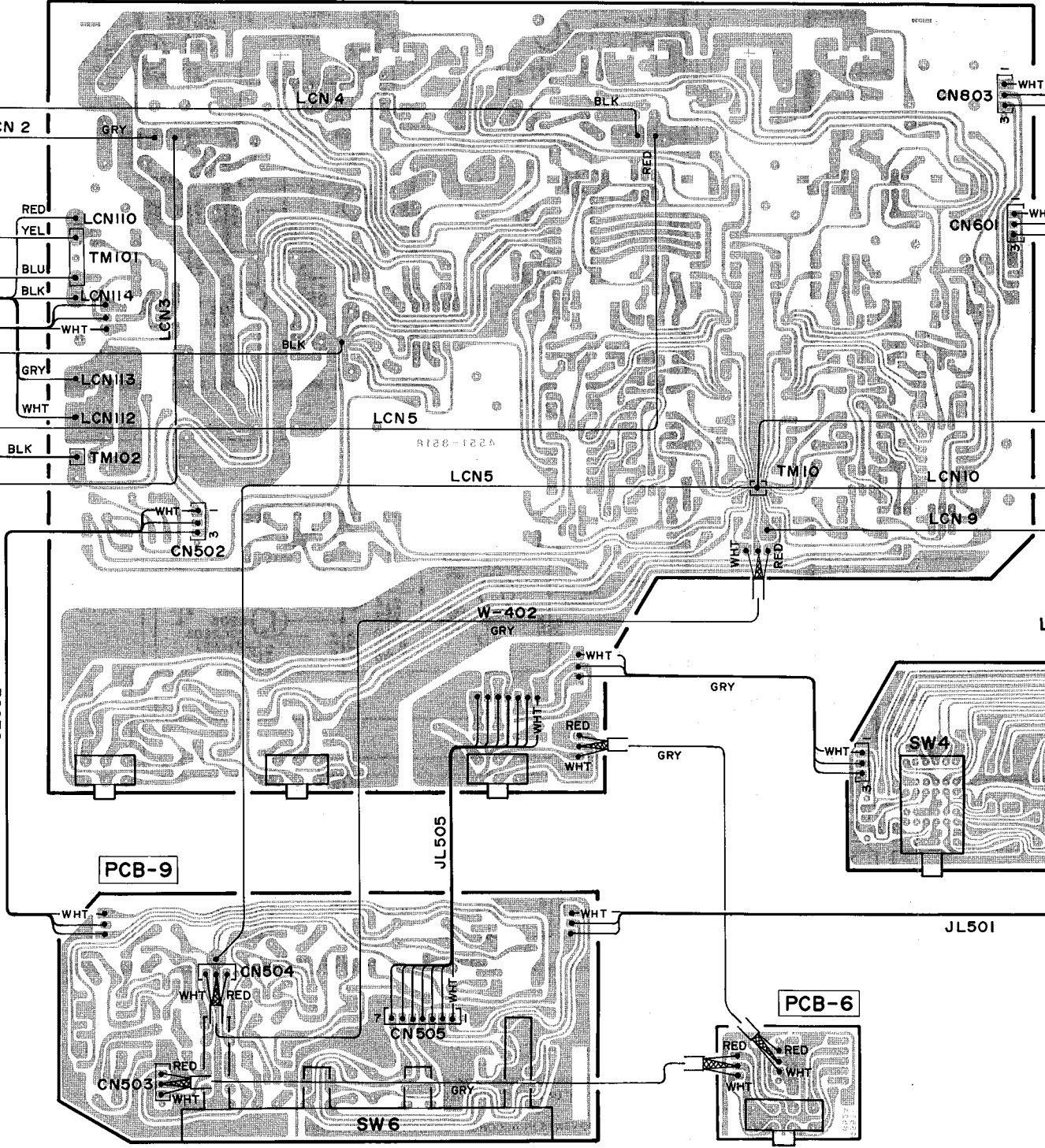
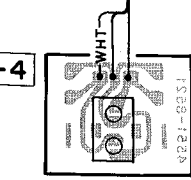
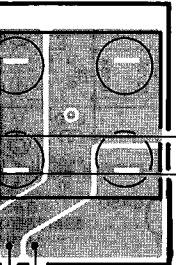

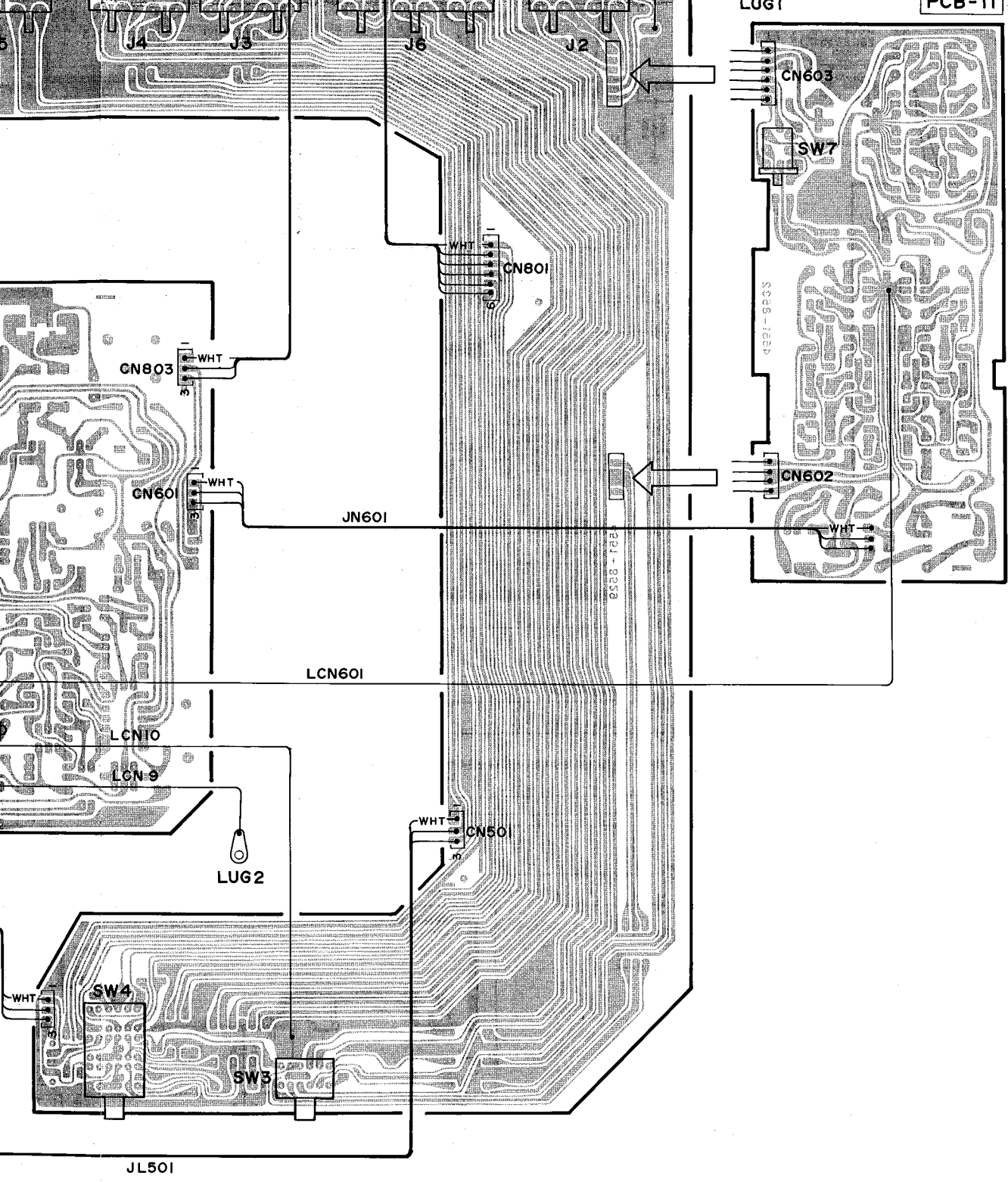

B-6

